



Configurator Training Guide

Version 7.1



Copyright

Copyright © ELAN Home Systems, LLC. All Rights Reserved.

All brand or product names used in this document are trademarks, registered trademarks, trade names, or service marks of their respective holders.

Material in this document is subject to change without notice: contact ELAN if you would like to confirm that you have the most recent version.

ELAN Home Systems, LLC.

CORE Brands

1800 S. McDowell Blvd Corporate Circle

Petaluma, CA. 94954

Document Revision: 11/17/2014

Contents

Lesson 1: Training Setup	1-1
Exercise 1: Install g!Tools	1-2
Exercise 2: Install current Core Module	1-5
Exercise 3: Check the Installation and Start the Configurator	1-8
Exercise 4: Add Licenses to the g! System Controller Using Key Manager .	1-10
Lesson 2: Configurator Overview	2-1
About the Configurator Window	2-2
Exercise 1: Software Version and General Settings	2-6
Exercise 2: Check System Modes, Main Tabs and Modules (Apps).....	2-9
Exercise 3: User Settings in the Viewer	2-11
Change Passcode Settings.....	2-12
Manage Users.....	2-13
Door Lock Settings.....	2-14
Touch Screen Settings.....	2-14
Exercise 4: Setting Up Users	2-15
Exercise 5: Working with Touch Screen Settings.....	2-19
Exercise 6: Localization (Translating the Viewer)	2-21
Exercise 7: Backing up the System.....	2-25
Lesson 3: Configuring Security Systems	3-1
Security Integration Overview	3-2
Exercise 1: Add the Communication Device	3-4
Exercise 2: Add the Security Panel.....	3-6
Exercise 3: Check the Viewer	3-9
Exercise 4: Configure Wireless Locks.....	3-11
Exercise 5: Configure Door Lock Settings in the Viewer	3-16
Exercise 6: Use the Viewer to Secure and Unsecure Wireless Locks	3-20
Exercise 7: View the Event Log for Wireless Locks	3-23
Lesson 4: Configuring Climate Systems	4-1
Climate Integration Overview	4-2
Exercise 1: Add a Communication Device	4-4
Exercise 2: Add the Heating/Cooling Equipment	4-6
Exercise 3: Discover and Configure Thermostats	4-8
Climate Scheduling Overview	4-10
Exercise 4: Set Schedules	4-11
Exercise 5: Check the Viewer	4-16
Exercise 6: Check the Schedule tabs in the Viewer.....	4-19
Exercise 7: Check the History in the Viewer	4-24

Lesson 5: Configuring Lighting Systems	5-1
Lighting Integration Overview.....	5-2
Exercise 1: Add Communication Device	5-4
Exercise 2: Add the Lighting System and Discover Devices	5-6
Exercise 3: Create a Custom Keypad	5-9
Exercise 4: Add Scenes to Keypad Buttons.....	5-13
Exercise 5: Create a Custom Interface	5-15
Exercise 6: Copy the Custom Tab to a Different Resolution	5-22
Exercise 7: Set up a Schedule in the Viewer	5-24
Lesson 6: Distributed A/V: Part 1	6-1
Distributed A/V Integration Overview	6-2
Exercise 1: Setup the Content Tab	6-3
Exercise 2: Configure the Internal Player.....	6-6
Exercise 3: Add an RS-232 Source with a Built-in Driver & Interface	6-10
Exercise 4: Add the Audio Zone Controller	6-13
Exercise 5: S86A Source Settings	6-15
Exercise 6: Add Sources to the Zone Controller	6-17
Exercise 7: Configure Zones.....	6-21
Exercise 8: S86A Zone Settings	6-24
Exercise 9: Configure Zones in the Viewer	6-27
Exercise 10: Check the Viewer	6-29
Lesson 7: Distributed A/V: Part 2.....	7-1
Distributed A/V Integration Overview	7-2
Exercise 1: Add an IR Cable TV Set Top Box.....	7-3
Exercise 2: Add Video Sources to the Zone Controller	7-7
Exercise 3: Add IR Library Displays.....	7-8
Exercise 4: Configure the Video Displays for the Zones	7-10
Exercise 5: Add the Video Switch and Configure Sources and Zones.....	7-12
Exercise 6: Configure the Video Switch to Follow Audio Zones (Slaving)....	7-16
Exercise 8: Configure Zones in the Viewer	7-18
Exercise 9: Check the Viewer	7-20

Lesson 8: Configuring Home Theater Systems	8-1
Home Theater Integration Overview	8-2
Exercise 1: Add an IR Device and Import Codes from the Common Resource Library	8-3
Exercise 2: Add a Communication Device and Receiver	8-6
Exercise 3: Add the Internal Tuner Source	8-8
Exercise 4: Configure Sources.....	8-9
Exercise 5: Output from Zone	8-11
Exercise 6: Add Serial Driver for a Display	8-15
Exercise 7: Add Video Display in Media Tab	8-18
Exercise 8: Assign Display to a Zone.....	8-26
Exercise 9: Configure Zones.....	8-31
Exercise 10: Check the Viewer Interface	8-35
 Lesson 9: IR Control.....	 9-1
Overview	9-2
Exercise 1: Built-in IR Control on the HC Series Controllers.....	9-4
Exercise 2: Overview - IR Devices and IR Codes	9-6
Exercise 3: Add an IR Device and Import an ELAN EIR file from g!Tools....	9-12
Exercise 4: Add an IR Device and Learn Codes Using the ELAN IRL2	9-18
Exercise 5: Check and Optimize Codes.....	9-23
Exercise 6: Export IR File.....	9-30
Exercise 7: Add an IR Controlled Display	9-32
Exercise 8: Create and Customize an Interface for an IR Source	9-42
Exercise 9: TV Channel Favorites.....	9-47
Exercise 10: Set Up IR Display as Zone Controller.....	9-51
 Lesson 10: Generic Serial Control (One-way)	 10-1
Overview	10-2
Exercise 1: Add Generic Serial Devices from a Protocol Document	10-4
Exercise 2: Create a Generic Display	10-12
Exercise 3: Import a Serial File from g!Tools for a Generic Serial Source .	10-21
Exercise 4: Add the Interface for Generic Serial-controlled Source	10-27
 Lesson 11: Configuring Video Systems.....	 11-1
Video Overview.....	11-2
Exercise 1: Add a Single IP-Based Network Camera	11-3
Exercise 2: Add an ONVIF™ IP Camera	11-5
Exercise 3: Add an Analog Video Camera.....	11-8
Exercise 4: Check the Viewer Interface	11-11

Lesson 12: Messaging	12-1
Messaging Overview.....	12-2
Exercise 1: Configure Messaging	12-3
Exercise 2: Configure Messaging Alerts (Email).....	12-5
Exercise 3: Setup Email Account.....	12-10
Exercise 4: Check the Viewer	12-13
Lesson 13: Configuring Irrigation Systems	13-1
Irrigation Integration Overview	13-2
Exercise 1: Add the Communication Device	13-4
Exercise 2: Add the Irrigation Controller	13-6
Exercise 3: Add Irrigation Groups and Irrigation Zones	13-7
Exercise 4: Add Global Irrigation Periods	13-10
Exercise 5: Check the Viewer	13-11
Lesson 14: Configuring Pool Systems	14-1
Overview	14-2
Exercise 1: Add the Pool Controller	14-3
Exercise 2: Check the Viewer	14-5
Lesson 15: Interfaces.....	15-1
Overview	15-2
Exercise 1: Identify and Name Individual Interfaces	15-3
Exercise 2: Explore Interface Settings	15-5
Exercise 3: Home Page Setting	15-7
Exercise 4: Creating a Custom Home Page.....	15-9
Exercise 5: Configuring the gKP7	15-16
Exercise 6: Adding and Configuring a TS2L	15-27
Exercise 7: Configuring the gTP7	15-32
Exercise 8: Configuring TS7/TS10/Valet10 Touchscreens	15-43
Exercise 9: Configuring the On Screen Display (OSD)	15-51
Exercise 10: Adding and Configuring the HR2 WiFi Remote	15-66
Lesson 16: Event Mapper	16-1
Event Mapper Overview.....	16-2
Exercise 1: Arm the Security System on Away House Mode	16-5
Exercise 2: Set Home Mode on Security Disarm	16-8
Exercise 3: Check the Commands.....	16-10
Exercise 4: Doorbell Triggers Jump to Video Tab.....	16-13
Exercise 5: Use Relay Outputs to Open a Gate.....	16-15
Exercise 6: Run-Once Timer.....	16-18
Exercise 7: Timed Event	16-23
AV Macro Examples	16-28

Your Resources at ELAN

In addition to the information in this Training Guide, be sure to check out ELAN's website at www.elanhomesystems.com. The website provides access to a wealth of documentation including *Integration Notes* for detailed information on specific systems with which the g! software integrates.

Our **Technical Support** staff can assist you Monday through Friday from 9:00 a.m. to 7:00 p.m. EST and 6:00 a.m. to 4 p.m. Pacific at **800-622-3526**.

Email: techsupport@elanhomesystems.com

Lesson 1

Training Setup



Overview

This lesson prepares your computer for the training lessons to follow.

You will:

- Install g!Tools, which allows you to manage Viewer and Configurator connections for your customers, and also includes documentation, firmware, IR & Serial Database, and a TV/Radio icon library.
- Check the installation of the g! software.
- Use g!Tools to access the Key Manager to add keys to the controller to enable additional third-party Viewer licenses.

Requirements

- A computer running Windows® XP, Windows Vista, or Windows 7
- Access to the g!Tools Installer

Exercise 1: Install g!Tools

Overview The g!Tools program is a valuable resource for the dealer setting up a g! system. The **My Systems** list provides a dashboard for all the systems you have installed. This screen displays information that will assist you with troubleshooting, as well as an entry point into each selected system so that you can access its Viewer or Configurator remotely. Use the **Key Manager** to configure software licenses for additional g! viewers that are installed on each system's controller.

g!Tools is also a repository of technical information and files that are needed to set up g!Connect for your customer, such as:

- Manuals, Integration Notes and other documentation
- IR codes and Serial codes
- Language files for localizing the user interface
- TV Channel icons
- Firmware for ELAN equipment

g!Tools is not only a resource tool, but is also the storage area for icons and codes used in the g! Configurator. When g!Tools is installed on your PC, Configurator takes you to the correct directory where the necessary files are stored.

This software automatically updates with the latest files from ELAN and the files are stored locally, so they are available to you without an internet connection.

How-to

1. Navigate to the **g!Tools** installer (on your training CD). Double-click the installer to begin the installation.

Note: If you are using Windows Vista, right-click the installer and select Run as Administrator.

2. Follow the on-screen instructions to accept the license agreement and install the library files and program.

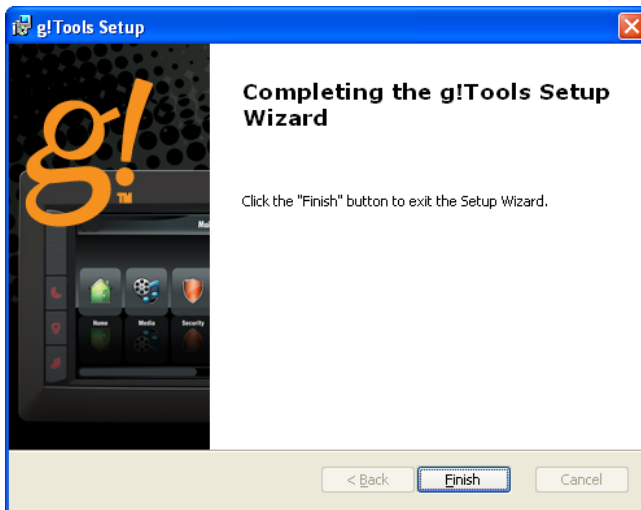
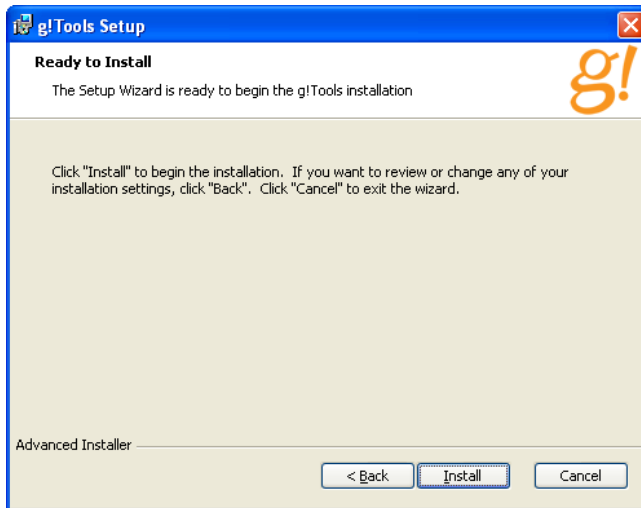

- Once the installation is complete, launch the application from the desktop icon to access g!Tools. *The welcome screen displays for a moment, and then g!Tools opens with the My Systems page displayed.*

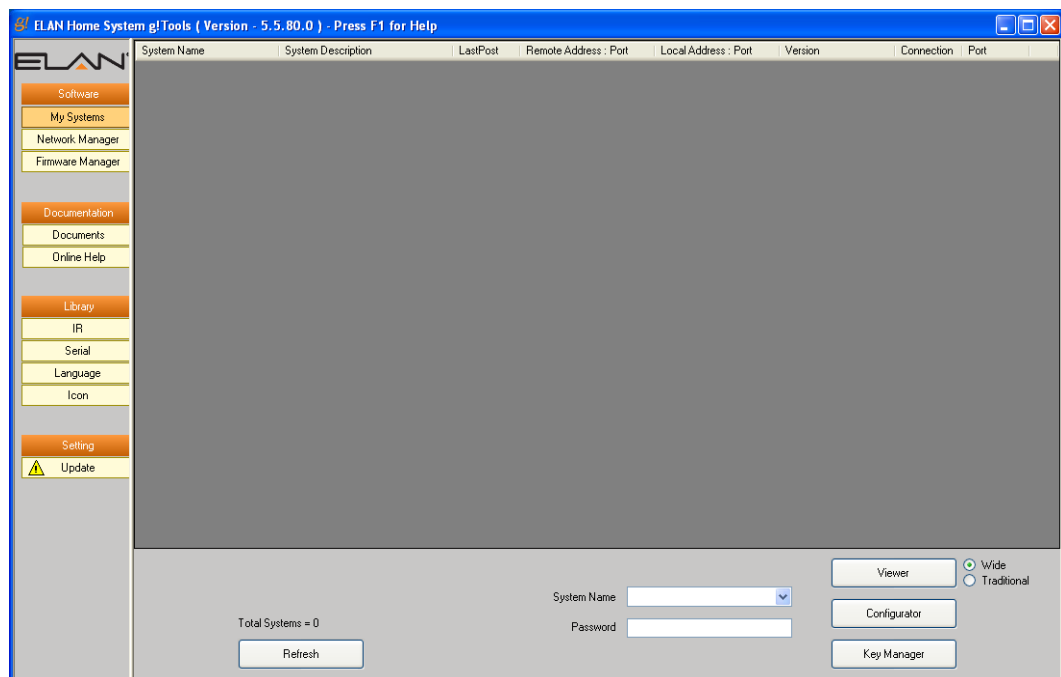

- From within g!Tools, you can manage client systems, and also browse or update documentation and databases stored on your PC.

Note: See the *g!Tools User Guide* for information on how to use this software.

Exercise 2: Install current Core Module

Overview The g1 controller build of software at your workstation may need to be updated. This software can be found on the Resource USB driver provided in class or on the ELAN dealer website.

Note: The installation files used in this class are provided in the Training Resource USB drive that your instructor will give you.

How-to

1. Locate the Core Module Installer on the training resource USB drive.
2. Start the Installation Wizard.
 - a. If you are running Windows XP, double-click the Installer to start the installation wizard.
 - b. If you are using Windows Vista, Windows 7, or Windows 8 right-click the installer and select **Run as Administrator**. *The g!Upgrade window appears.*

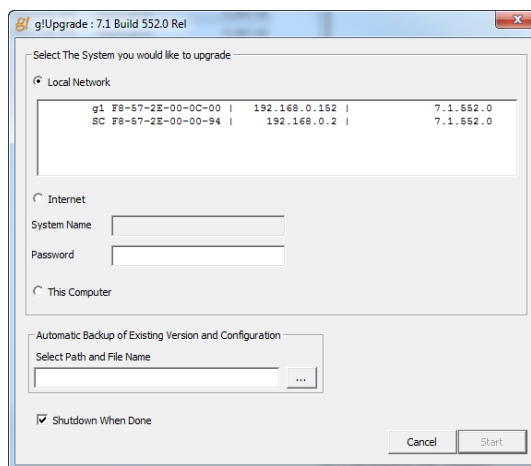

3. In the **Local Network** section click the **g system controller to update**.
4. Select **Start** to begin the update.

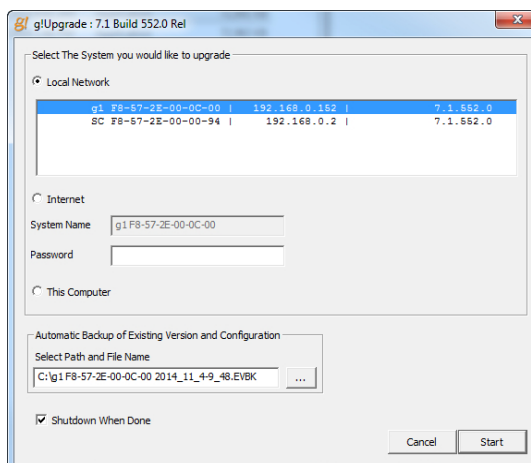

- A Warning pop-up appears. Ensure the PC is hardwired to the network and select **Yes**.

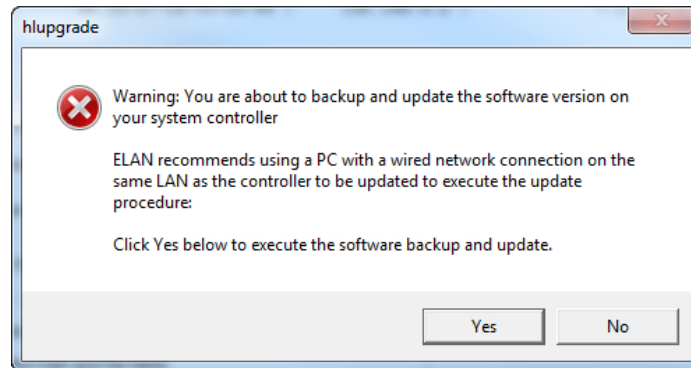

- The Core Module update begins by Backing up the complete system controller and configuration. *The File Name field indicates where the backup file is stored on the PC.*

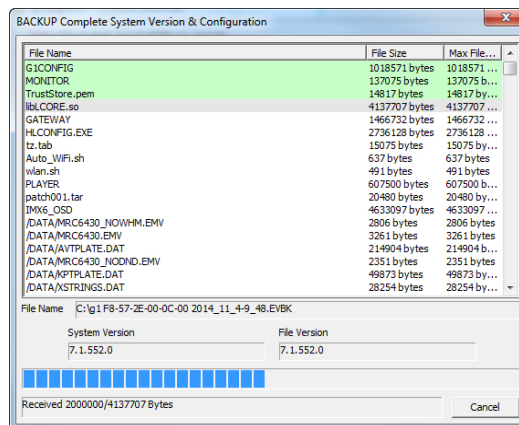

- After the backup the Core Module begins updating.

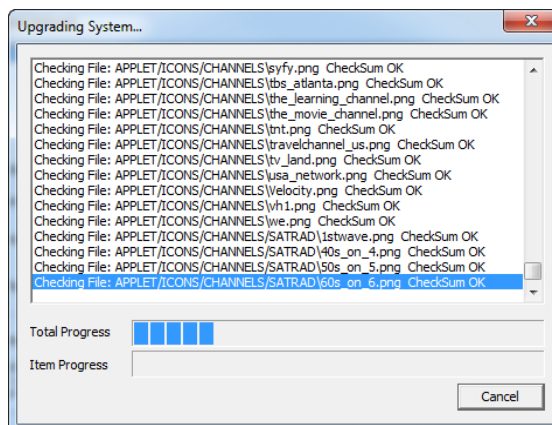

8. When finished a window appears letting you know the update is complete. Select **OK** to close the g!Upgrade window.

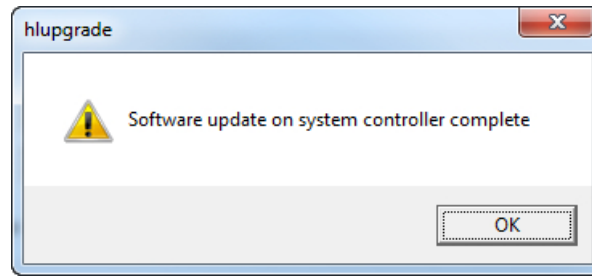

Note: After a g! Core Module update is performed the g system controller automatically re-boots. This process takes 5 to 10 minutes to complete and the g controller is offline during this time.

Exercise 3: Check the Installation and Start the Configurator

Overview Before you begin Exercise 3, you must have g!Tools installed on your computer. This exercise walks you through the steps to start both the Viewer and Configurator software.

Note: You may want to have both the Viewer and Configurator running at the same time. The Viewer updates in real-time, making it a useful tool for checking your configuration settings.

How-to

1. Double-click the **g!Tools** icon on your desktop.
2. Select the **g controller** from the **System Name** drop down, and then click the **Configurator** button. *The configurator for the selected g system opens.*

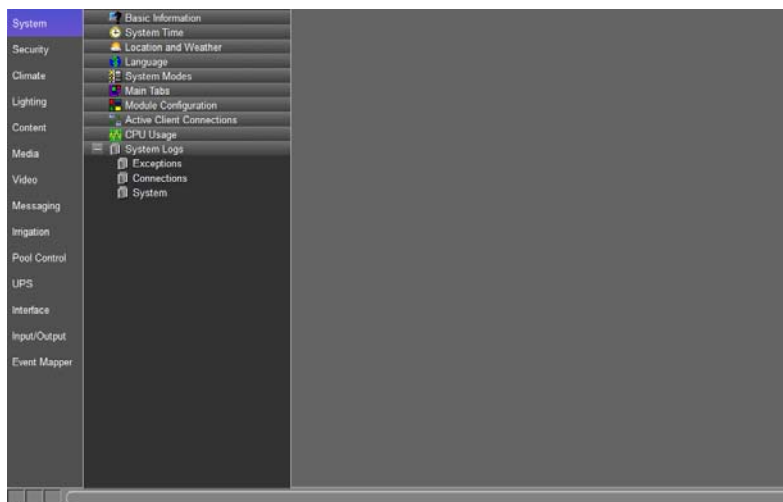
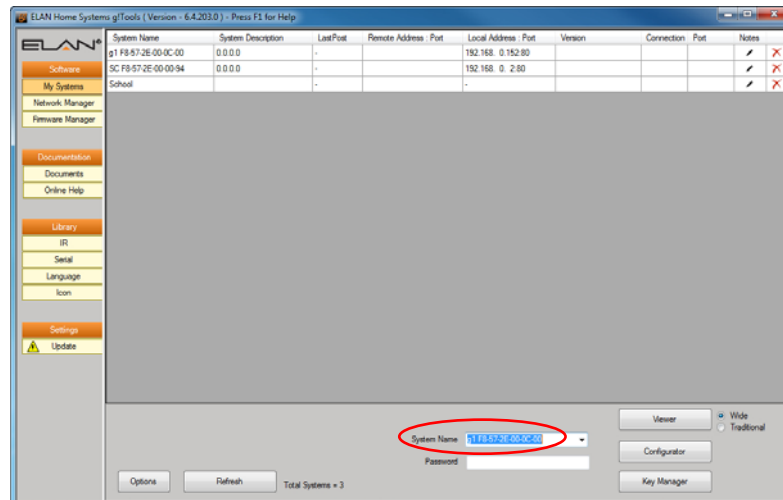

4. In the g!Tools **System Name** field, verify that the **g controller** is still selected, and then click the **Viewer** button. *The Viewer interface will display.*



Exercise 4: Add Licenses to the g! System Controller Using Key Manager

Overview All g! system controllers ship with ready to use functionality for all sub-systems, and include two Viewer licenses to support two, third-party user interfaces such as a PC or iPhone. Included functionality allows control of supported subsystems in small, medium, or large configurations, with no additional cost beyond the controller. Controllers may be upgraded with additional viewer seats for more Viewer clients; bearing in mind that ELAN user interfaces do not require a Viewer license.

Additional licenses, when ordered, arrive in the mail as a 4"x4" card with a unique license code printed on it. These license codes are used with the Key Manager application installed with g!Tools to activate the codes and unlock functionality on the Controller. When you order additional Viewers, there is one simple part number to use.

- **GVSL:** The GVSL license is a Viewer seat, which increases the number of simultaneous connections from Third-Party Viewers that the g! system controller will accept. The GVSL adds 30 Viewer Seats to the system controller, allowing up to 32 simultaneous connections. Third-party Viewers include any local or remote Viewer connection to the system controller that is not from an ELAN touch screen, including PC's, iPhones, Android phones, or tablets. Note that Viewers are not locked to any one device, and only limit the number of simultaneous Viewer connections. Key codes can only be used once on one system.

In Exercise 5, you will install a key on the g! system controller for the Viewer seating license

Key Manager is designed to support installations where internet access is not available to activate the license, and as you will note in the following diagram, you can easily register a system with your computer on site, activate licenses off site (at the office or a local Wi-Fi hotspot), and then return to the controller to install your Viewers. The process for implementing the keys is explained in the following diagram.

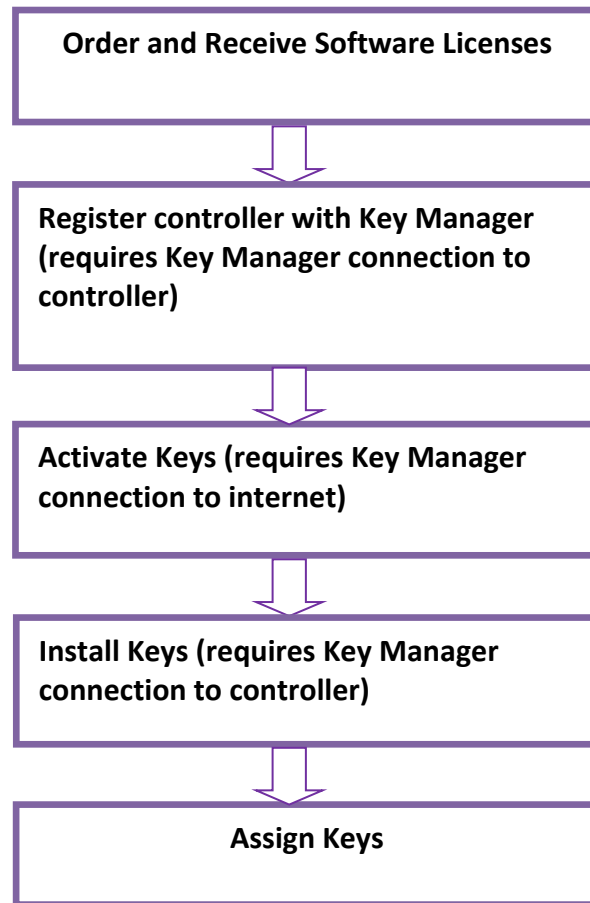

How-to Once you receive your keys, you can proceed with key activation.

1. Open g!Tools, select the customer system you want to work with on the My Systems list, then click the **Key Manager** button. *The Key Manager program opens for the selected system.*

Note: If you did not register at the time of g!Tools installation, you are prompted to register. Registration is required to use Key Manager, and you must have Internet access to perform this step.

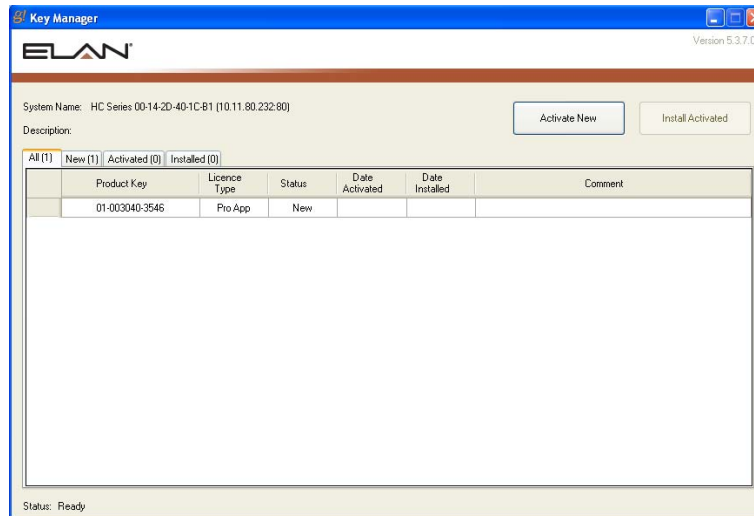

The Key Manager connects to the g! system controller and presents the Key Activation and Installation screen. *If you do not have Internet access, a message will display indicating that key activation is disabled.*

Note: You must connect to the g! system controller when on-site and register the system with your computer in order to activate keys. If you have no internet access on site, make sure that you perform Step 1 prior to leaving the site to activate keys!

2. Activate the keys from the Manage Keys window for the current system.

The information displayed on the lower left of the KeyManager window indicates the current state of Key Manager such as “Ready” or “Activation Disabled.” *Activation verifies that the keys have authentic and unused licenses. Always double-check that you are activating keys on the correct system.*

Note: Internet connection is required for Step 2.

- a. Click the **New** tab to access the entry fields.
- b. Type the Product Key number, for each license that you want to activate, in the entry fields. *Be sure to enter the number exactly as shown on the Key Card.*

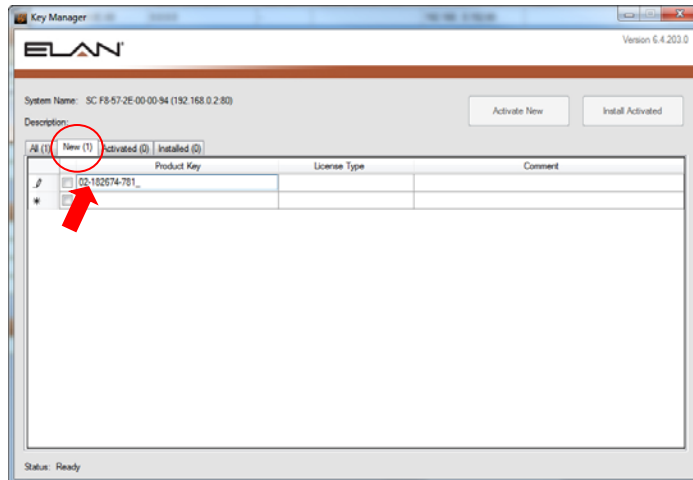

- c. Press **Enter** and the key(s) are verified. *Viewer* is displayed in the **License Type** column and the **Comment** column is highlighted if you want to add comments.

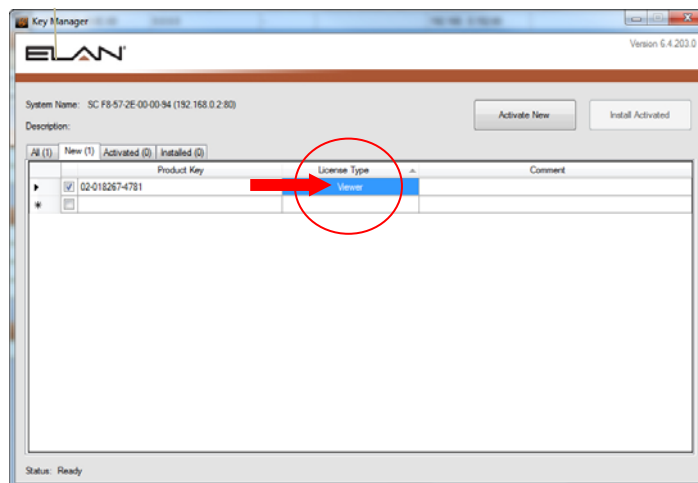

- d. When you are finished entering key codes, verify that the boxes are checked for all Viewer keys.
- e. Click the **Activate New** button.

Key Manager connects to ELAN's licensing server and verifies that the keys have not been used. The keys are then registered in the ELAN server database. The keys are activated and advanced to the **Activated** tab.

3. Install the keys from the Manage Keys window for the current system. The status on the lower left of the Key Manager window indicates the current state of Key Manager, such as "Ready" or "Installation Disabled." *All the activated product keys are installed on the system controller in this step and require connection from the Key Manager to the Controller.*

- a. Click the **Activated** tab to see the active product keys listed.
- b. Select all your keys, if they are not already selected, and click **Install Activated**.

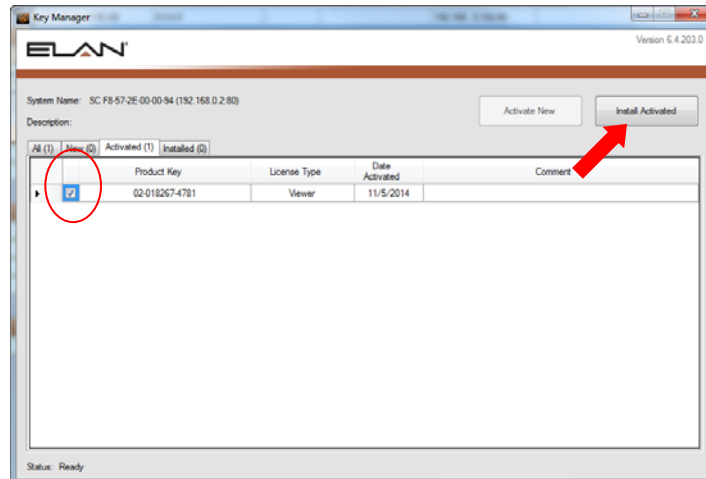

*The Product Key(s) are advanced to the **Installed** tab.*

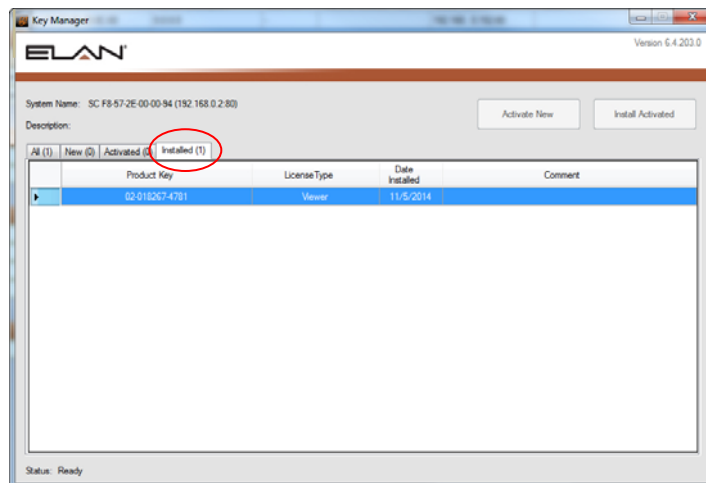

4. Once all the keys are activated and installed onto the controller, you can assign the keys in the Configurator.
 - a. In g!Tools, select the appropriate system from the My Systems list, and then enter a Password (if needed) and click the Configurator button at the bottom of the screen. The Configurator for the selected system opens.
 - b. Click the **System** tab.

- c. Click **Module Configuration** from the System Tree to display the App Configuration properties in the right pane of the Configurator.

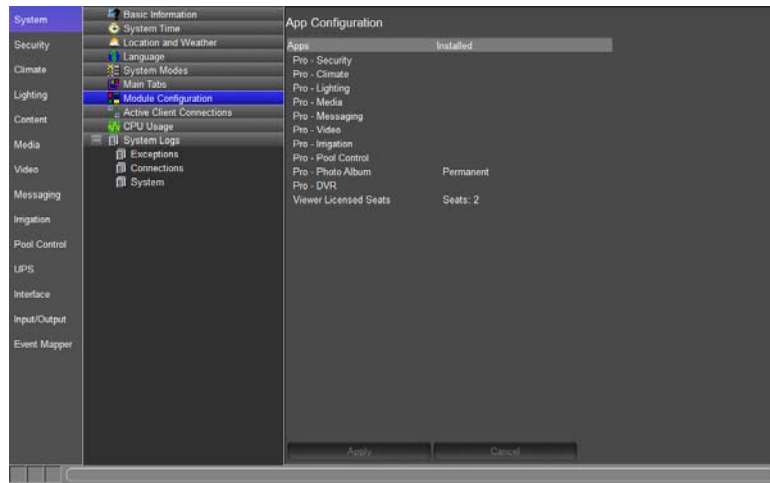

- d. Right-click the appropriate app under the **Installed** column and select the key from the pop-up menu.

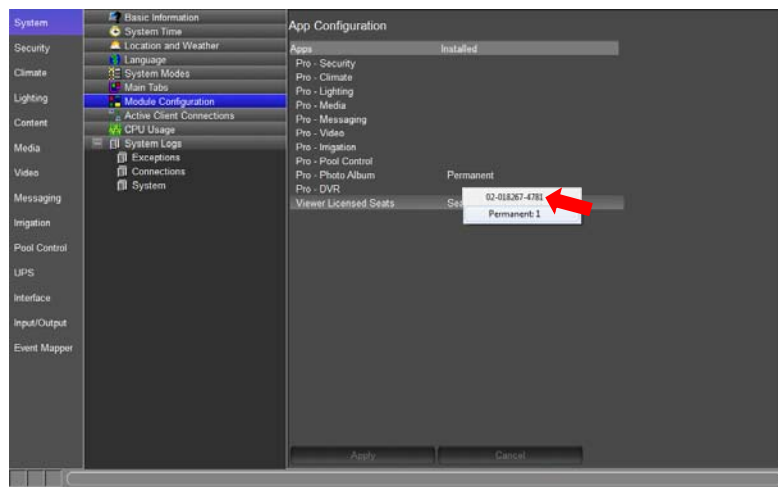

- e. Click **Apply** to add the key to that App. *The Configurator will configure Viewer Seat functionality.*

Lesson 2

Configurator Overview



Overview

This lesson provides an overview of the Configurator tool that sets up the g! system controller, and the Viewer.

In this lesson you will:

- Learn how the Configurator window is organized.
- Check basic system information, such as the software version.
- Check System Modes and Main Tab configuration.
- See the settings pages in the Viewer that are used to set up users, touch screens and wireless door lock settings.
- Use the Viewer to set up a new user.
- Change the language of the Viewer from English to a supported foreign language.
- Perform a Backup of your configuration.

Requirements

- g! system controller and g!Tools.

About the Configurator Window

Overview The **Configurator** software tool sets up and manages the g! system. The Configurator adds and configures devices such as thermostats, lighting devices, audio components, and others.

The Configurator has a simple point and click interface to allow you to make changes easily to the g! system controller. Like the Viewer, the Configurator is an interface to the g! system, controller where you can make real-time changes to the system. The Configurator cannot be used for off-line system configuration.

*Navigating
the
Configurator*

The Configurator is comprised of three sections:

- **System Tabs:** Main sections of the Configurator containing sub-system pertinent information.
- **System Node Tree:** The list of configuration options and devices for the selected System Tab.
- **Properties Window:** Detailed information and settings for the currently selected node in the System Node Tree.

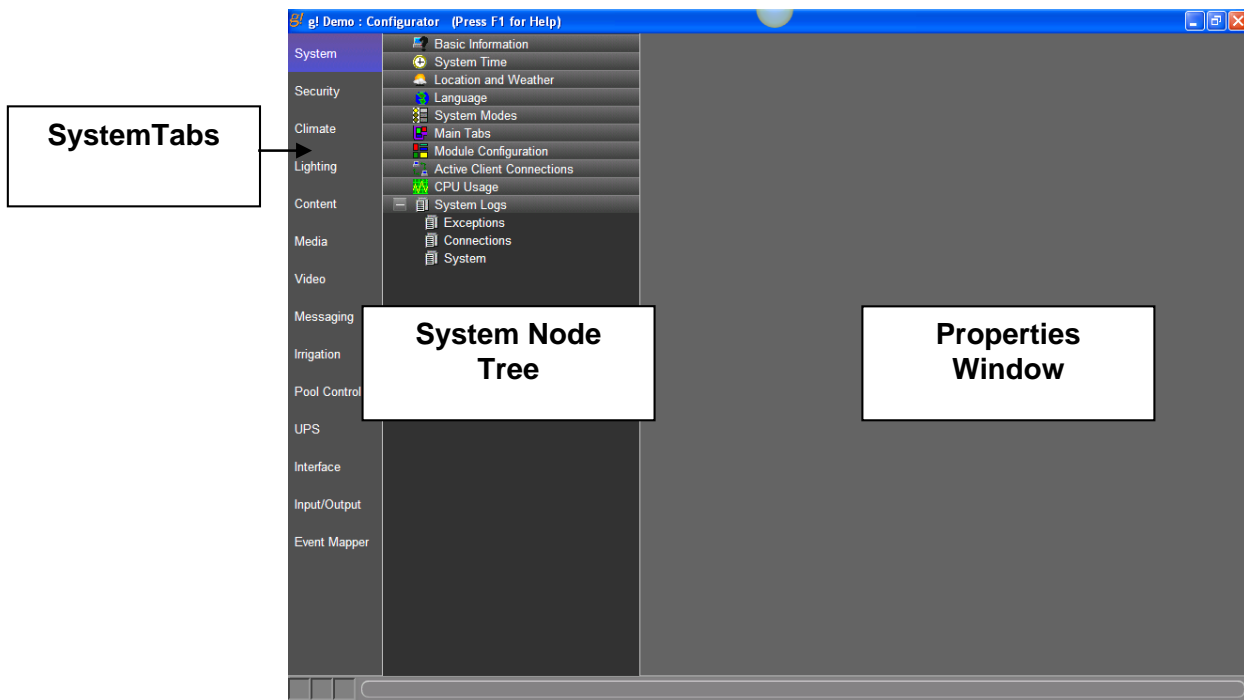

Information flows from left to right across the screen. When you click a system tab on the left, the System Node Tree displays information pertinent to that tab—devices that are set up for specific sub-systems, or appropriate groups of information for global settings. When you select an item in the System Node Tree, its parameters display in the properties window.

System
Security
Climate
Lighting
Content
Media
Video
Messaging
Irrigation
Pool Control
UPS
Interface
Input/Output
Event Mapper

System Tabs

The System tabs on the left of the screen are your primary navigation elements. System Tabs include the following:

- **System:** includes overall system settings, software version, date and time, user configuration, and system modes. This lesson contains further information on the System Tab.
- **Security:** configuration and status of devices, zones and partitions for integrated Security Panels and door locks. See Lesson 3, *Configuring Security Systems* for more information.
- **Climate:** configuration and status of devices, global climate settings, and scheduling for integrated climate control systems. See Lesson 4, *Configuring Climate Systems* for more information.
- **Lighting:** configuration and status of devices, scheduling, and custom interfaces pertinent to integrated lighting and shade systems. See Lesson 5, *Configuring Lighting Systems* for more information.
- **Content:** options for editing and adding favorite TV channel icons, adding music and photo share folders, and web pictures.
- **Media:** configuration and status of zone controllers, receivers, 2-way sources and other interfaces pertinent to audio and home theater control. See Lessons 6 through 8, *Configuring Distributed AV & Home Theater Systems* for more information.
- **Video:** configuration and status of video cameras and IP video servers, DVR and custom interfaces. See Lesson 11, *Configuring Video Cameras* for more information.
- **Messaging:** configuration of the modem for answering service/dial-in system control, voice mail boxes, email and text-to-speech alert messages. See Lesson 12, *Messaging* for more information.
- **Irrigation:** device, zone, schedule and group configuration of integrated irrigation controllers. See Lesson 13, *Irrigation* for more information
- **Pool Control:** configuration and status of devices and circuits for integrated Pool/Spa controllers. See Lesson 14, *Configuring Pool Systems* for more information.
- **UPS:** configuration and status of integrated Uninterruptable Power Supplies.
- **Interface:** adjusts user interface settings for individual touch screens and keypads. See Lesson 15, *Interfaces* for more information.
- **Input/Output:** configuration and status for input/output devices such as IR devices, one-way serial drivers, contact closures, sense inputs, and other system objects. See Lessons 6 through 10 for more information.

- **Event Mapper:** custom macro programming, such as turning lights on when a door is opened. See Lesson 16, *Event Mapper* for more information.

System Node Tree

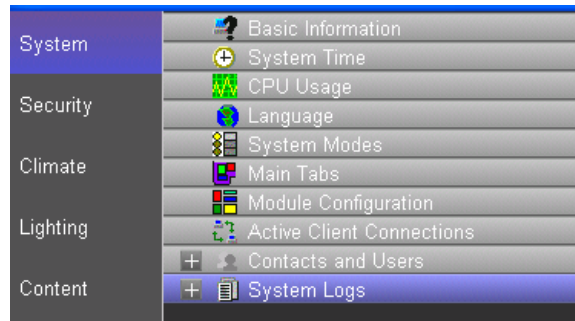

The **System Node Tree** in the middle of the screen displays a listing of sub-system devices or option groupings that can be selected for editing within a particular System Tab.

Items in the System Node Tree that have an arrow next to them when selected (highlighted) have additional options or actions that can be configured. Either right-click on the item, or click on the arrow box to display a pop-up menu containing the additional options or actions.

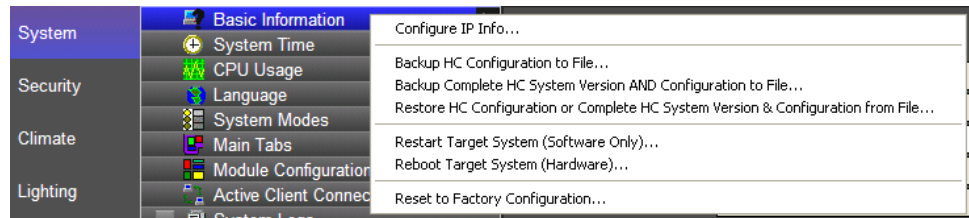

Properties Window

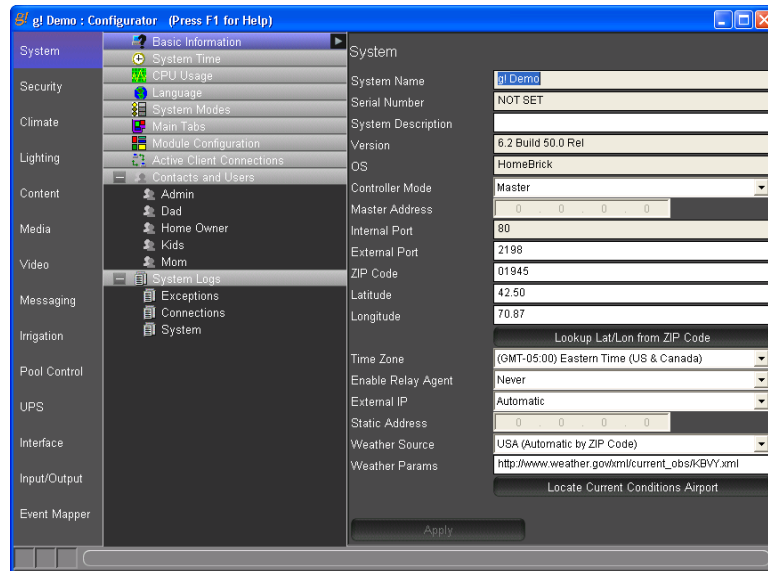

The **Properties** window at right shows details of the node selected in the System Node Tree. The properties window is typically used for specific device configuration, such as selecting a COM port, or editing the options for a device; but can include non-editable

reference information as well. Custom interfaces and home pages are also created in the properties window.

Online Help

Press the **F1** key on your keyboard at anytime to display Help for the Properties window that is currently open.

- Use the Contents on the left to navigate through the g! online help system.
- Use the Search tab to search for a specific phrase, such as a field name.
- The Glossary includes the terms from this Training Guide.

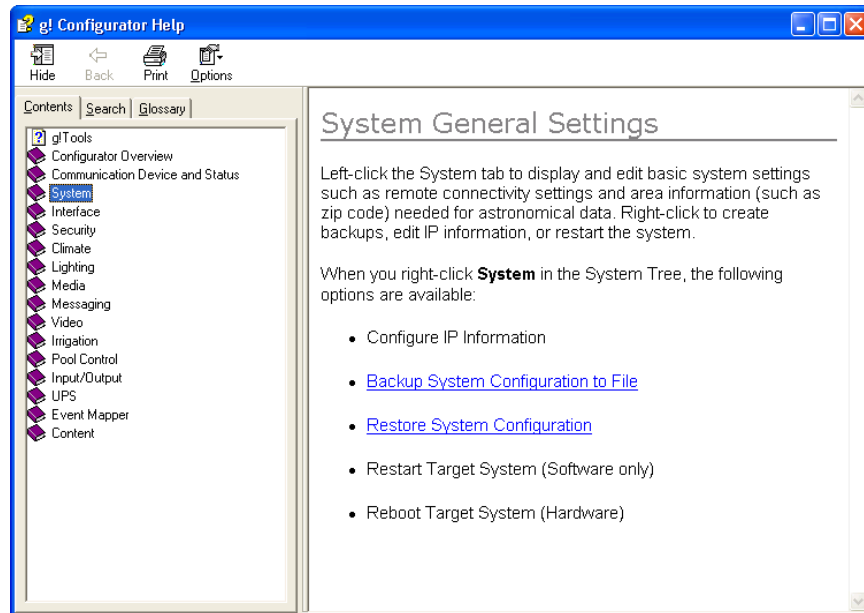

Exercise 1: Software Version and General Settings

Overview Exercise 1 demonstrates the System tab and explains several general parameters used in a g! system.

How-to

1. From the Configurator, click the **System** tab on the left side of the window if it is not active already. The window will open as follows, showing the System Node Tree in the middle section.

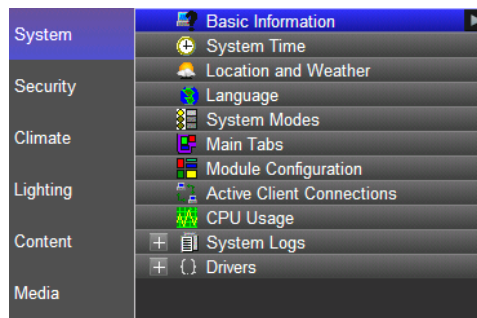

2. Click the **Basic Information** node in the System Node Tree to display the general system parameters.

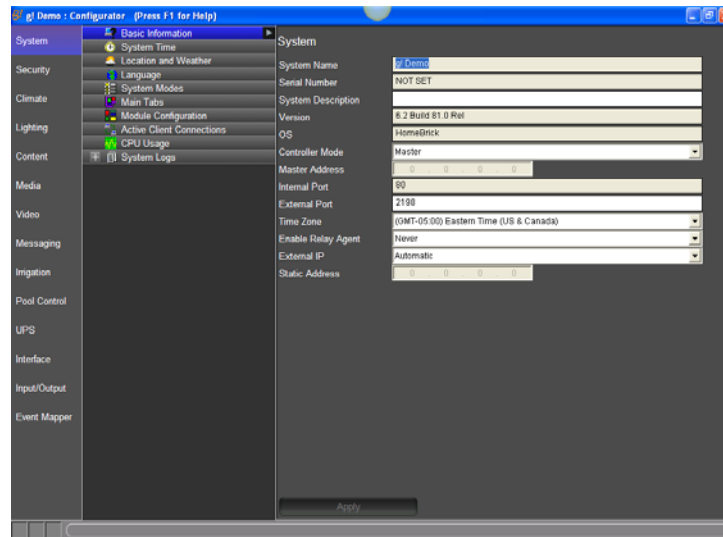

Quick Reference: Basic Information	
System Name	The remote login name. You cannot change this name, but the name can be changed by ELAN.
Version	The software version number, also known as the Core Module, of the controller to which you are currently connected.
Controller Mode	Select whether the controller is the Master controller , or an Extender controller. Master is selected by default.
Time Zone	Select the appropriate time zone for the system.

See the Configurator Reference Guide for a description of all the System Settings.

3. Click the **Weather and Location** node to display its settings. Complete this page for the location where the controller is installed.

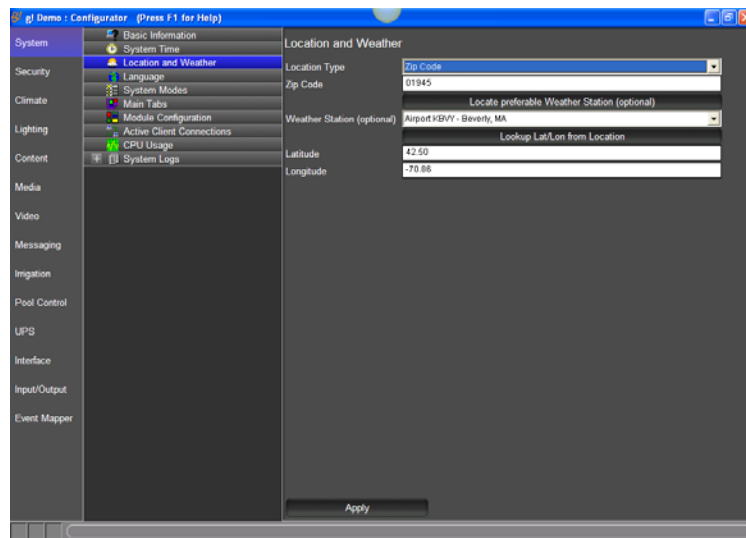

Quick Reference: Location and Weather	
Location Type	<p>Select one from the list. The other settings on this page will differ depending on the selected Location Type.</p> <ul style="list-style-type: none"> • ZIP Code. Recommended for US locations. • Country/City. Recommended for non-US cities. Type the name of the Country, and then click the Locate City button to populate the City list. • Latitude/Longitude. Manually enter the exact latitude/longitude for the location.
Weather Station (optional)	Select the desired weather station for the system. The temperature and current weather conditions from this station are displayed on the Viewer Home page.
Latitude/Longitude	The latitude and longitude for the location.

4. Enter a ZIP code and click the **Lookup Lat/Lon from Location** button. If you have internet access, after a moment the correct Latitude and Longitude should populate.
5. Click the **Locate preferable Weather Station** button. Select the weather station to use for “current conditions” information (usually the closest airport) and click **OK**. Click **Apply** to save the settings.

Note: Correct ZIP code, latitude/longitude, time zone and airport must be entered for astronomical settings such as sunset/sunrise scheduling, weather icons, current weather conditions, and outside temperature to be effective.

Exercise 2: Check System Modes, Main Tabs and Modules (Apps)

Overview Exercise 2 explains the current system settings.

Terms The following terms are important to know for this exercise:

- **System Modes:** Different states that the system can be set to; for example, “Home” when the homeowner is present and “Away” for when the house is empty. System Modes are primarily used to set up schedules for lighting and climate control, but you can add additional functions through the Event Mapper. System Modes allow the homeowner one-touch control of the behavior of several sub-systems. Although most installations use the default number of two modes, up to ten can be configured through the System tab.
- **Main Tabs:** Allows for changing the order of the icons that appear on the main menu page of the Viewer interface to provide access to an App. You can change the order of the icons, and change the text that appears above each icon. This legacy term is only used in the Configurator.
- **Module Configuration:** Allows enabling the Pro App feature set of a sub-system, such as security, irrigation, lighting, etc. Pro App features require a GPASL for each sub-system. GPASL's are managed in g!Tools using the g!Key Manager.

How-to 1. Click **System Modes** in the System Node Tree as shown below. *In this screen, notice that the system is set up with 2 modes, Home and Away.*

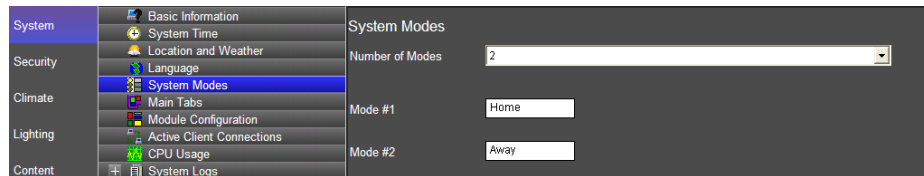

Notes: From this screen you can add up to 8 more modes for a total of 10 house modes. For each mode you will need to configure a button to display on the Home page in the Viewer to select and indicate the currently active mode.

- Click the **Main Tabs** node in the System Node Tree to display the Main Tab settings.

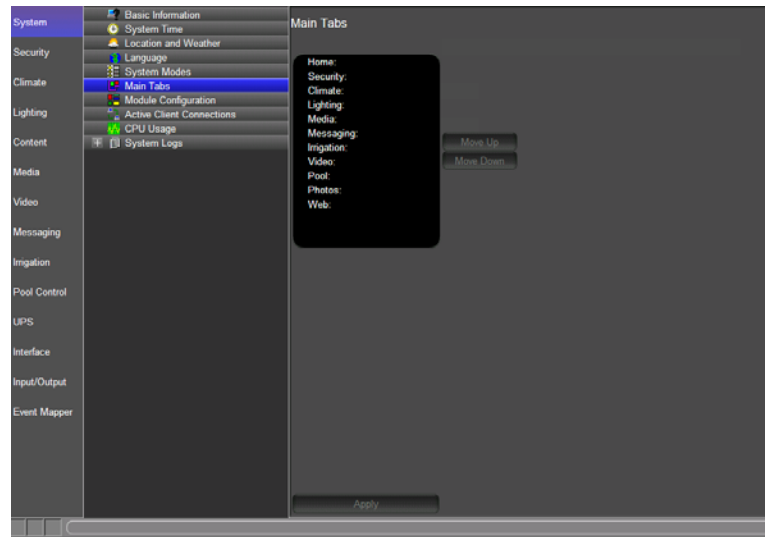

Note: When you click on a specific system tab name in the list you can change the order that the system tabs are displayed in the g!Viewer.

- Click the **Module Configuration** node in the System Node Tree to display the software licenses (the Apps) which are all enabled on the controller. Note the amount of Viewer License seats is 2.

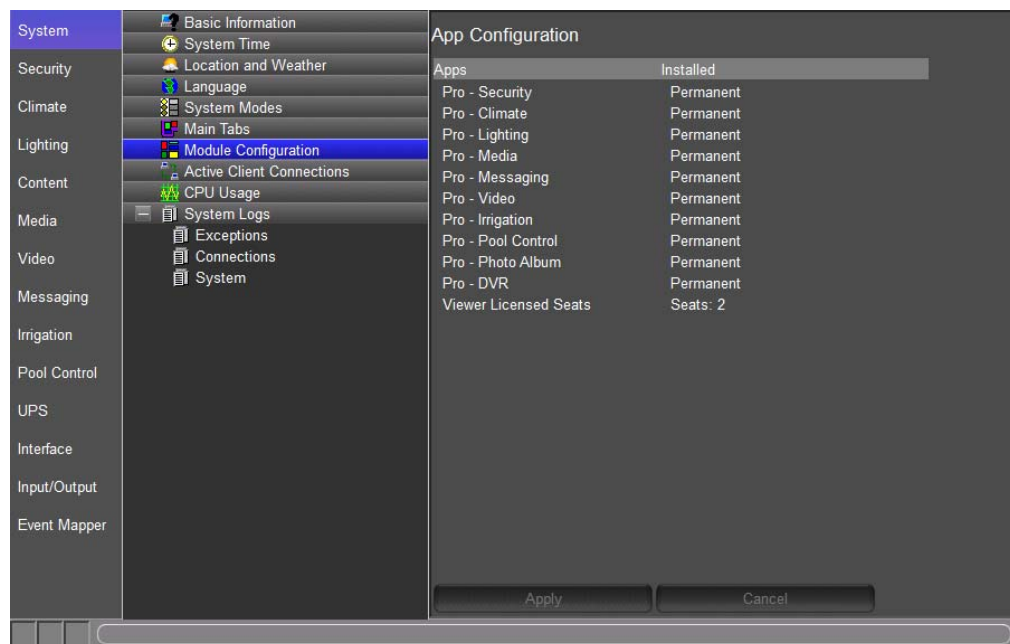

Exercise 3: User Settings in the Viewer

Overview Certain settings that enable specialized functionality within the g! software can only be set up in the Viewer. This provides the homeowner with a sense of privacy and control over pass codes that are used to access the Viewer, and wireless locks for their home.

The following information is set up or changed using the Viewer:

- Settings passcode
- User Access
- Door locks access
- Touch Screen Settings

How-to **To manage settings in the Viewer:**

1. From the main menu, click the User Settings icon in the upper right corner of the screen. A keypad displays to enter the passcode.

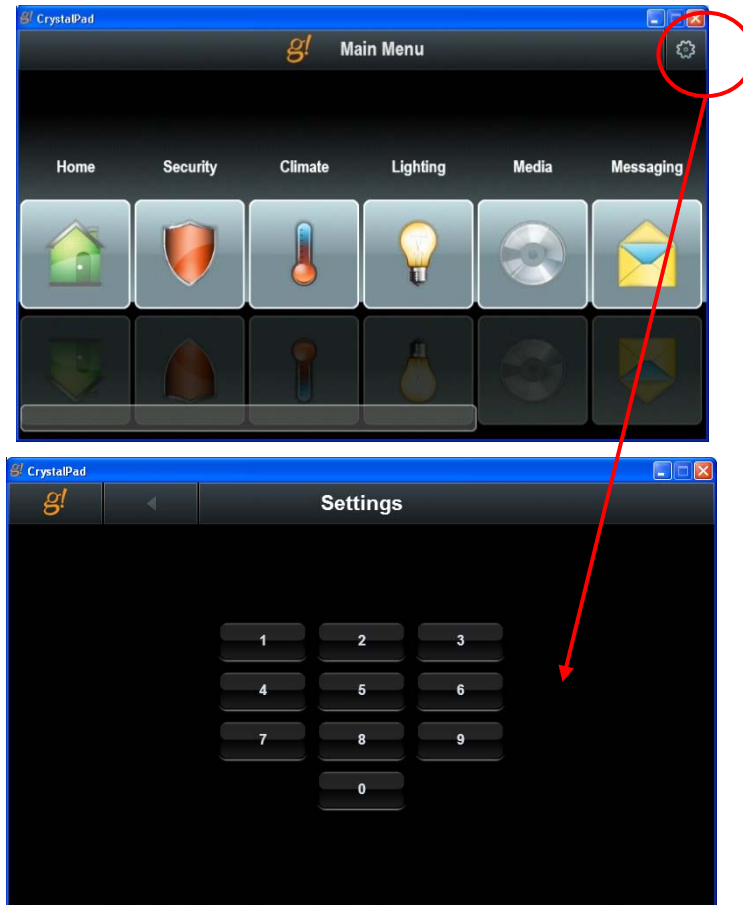

2. Click **1234** on the keypad. The main Settings page displays.

Note: 1234 is the default pass code for entering the Settings area. Use the Change Settings Passcode option described below to change this pass code to something more unique.

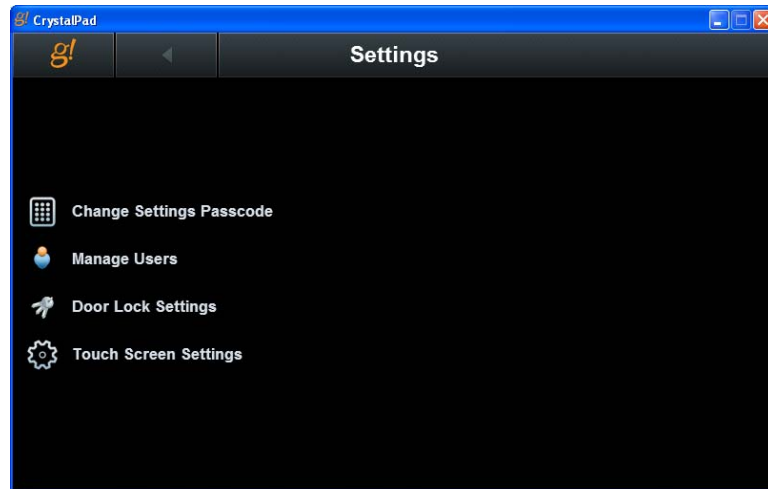

See the sections below for instructions for each settings option.

Change Passcode Settings

To change the passcode used to access the settings page:

1. Click **Change Settings Passcode** on the Settings main page. The Change Settings Passcode page displays.

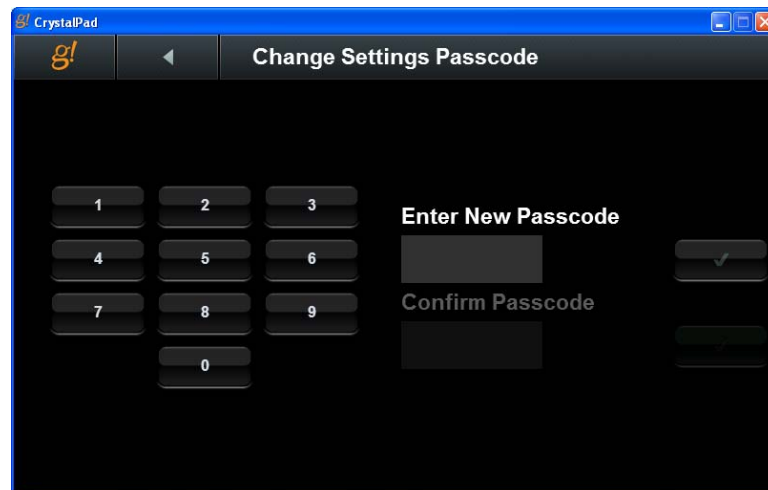

2. Click numbers on the on-screen keypad to enter a new passcode, then click the "check" button next the passcode field.

Note: The new passcode must be 4 numbers.

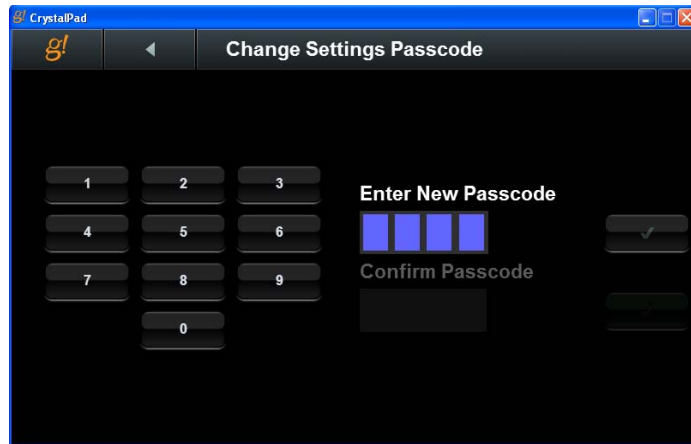

3. Re-enter the passcode in the **Confirm Passcode** field, and click the button next to the field to confirm the new passcode. The passcode is changed and the main Settings page displays.

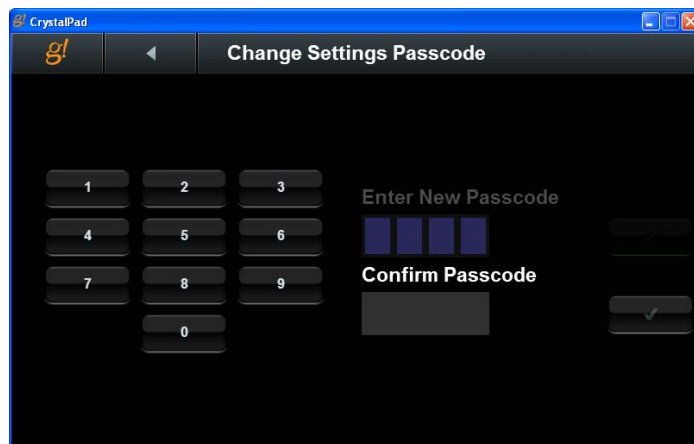

Note: If a passcode is lost or forgotten, please contact Technical Support for assistance with resetting the passcode.

Manage Users

The Manage Users page is used to set up the g! system users for the home, and specifies the features each user can control. See Exercise 4, Setting Up Users for more information.

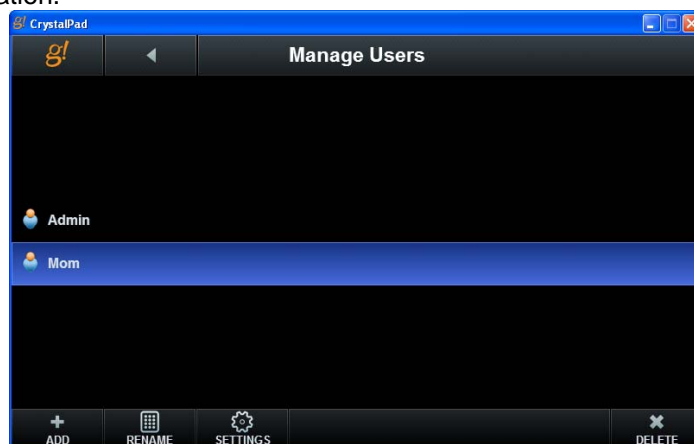

Door Lock Settings

The Door Lock Settings page lists all the wireless locks that have been configured for the system, and the system users. Use this page to map the users to a lock slot, and indicate the locks that the user is allowed to access. See Exercise 5 in Lesson 3, *Security* for more information.

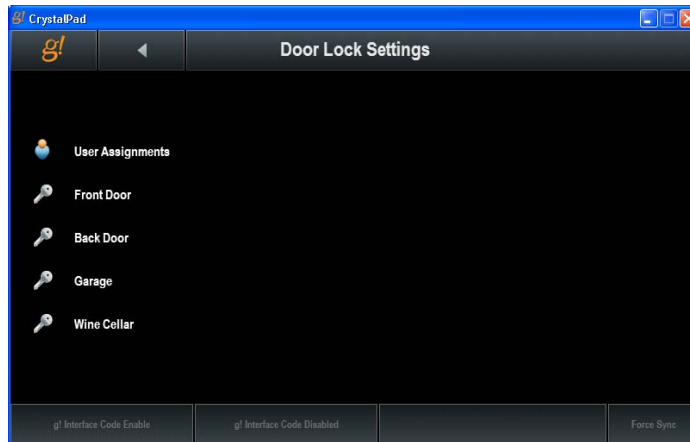

Touch Screen Settings

The Touch Screen Settings page lists each touch screen panel that has been configured for the system, and provides for the setup of secured access to each screen for each user. See Exercise 5, *Working with Touch Screen Settings* for more information.

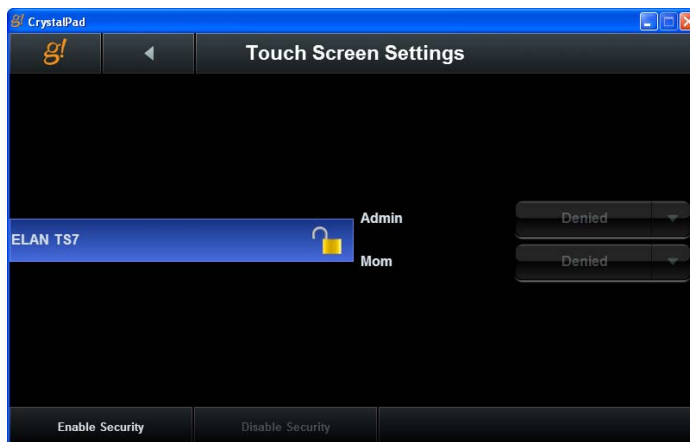

Exercise 4: Setting Up Users

Overview Users are set up in the Viewer. By default, one user – Admin— is set up, with the default passcode of 1234. Admin has access to both the Configurator and the Viewer, and can therefore make changes to the system.

In Exercise 3, you will change the passcode for **Admin** to prevent the end user from accidentally changing important settings. Then, you will add a new user that only has access to the Viewer (but not the Configurator).

How-to

1. In g!Tools select the g! system controller in the My Systems list, and then click the Viewer button at the bottom of the screen..

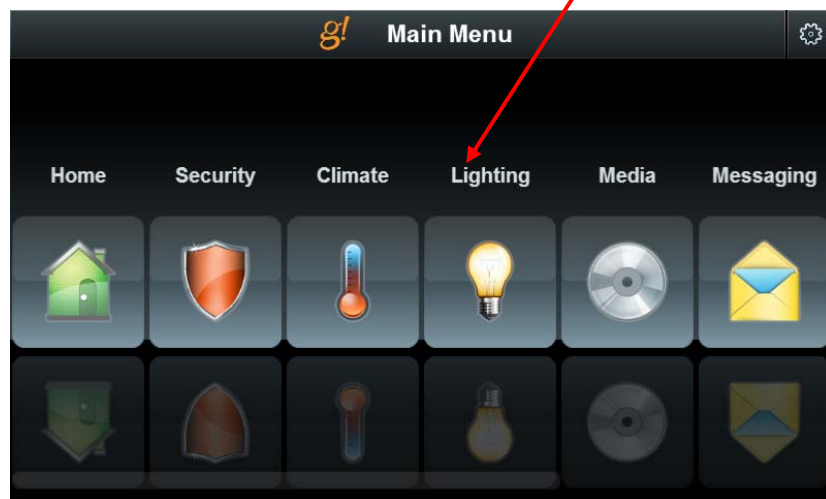
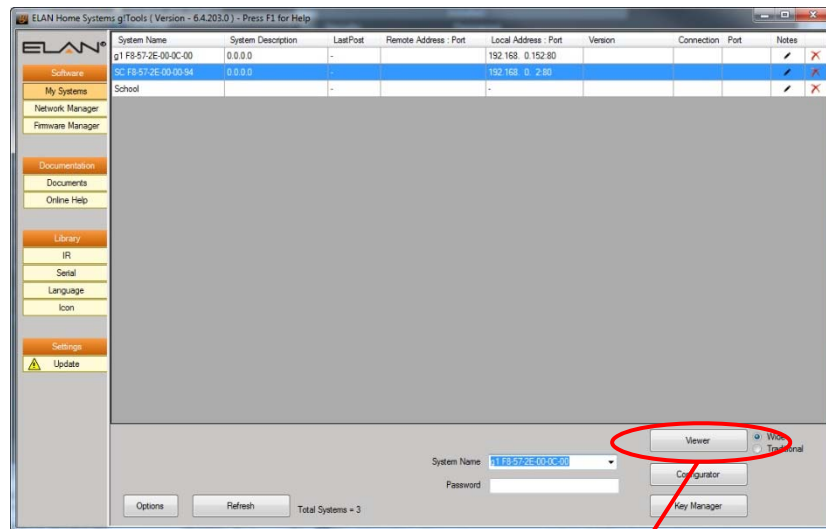

- Click the Settings icon  in the upper right corner of the screen. *The Settings keypad screen displays.*



- Click 1234 on the keypad. *The main Settings page displays.*

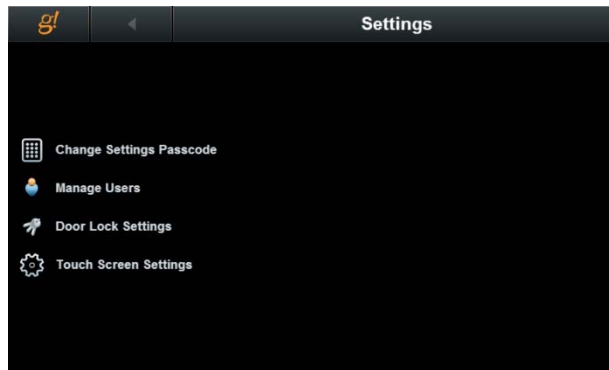

- Select **Manage Users** to display the Manage Users screen.

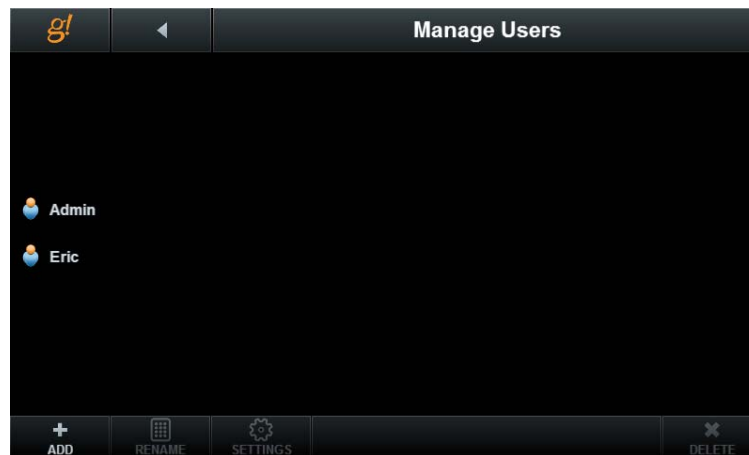

- Click the Add button  to add a new user to the list. The Add New User screen displays a keyboard. Enter the name of the new user, and then click OK/Enter. If using a PC interface then use the keyboard on the PC and press Enter when finished.

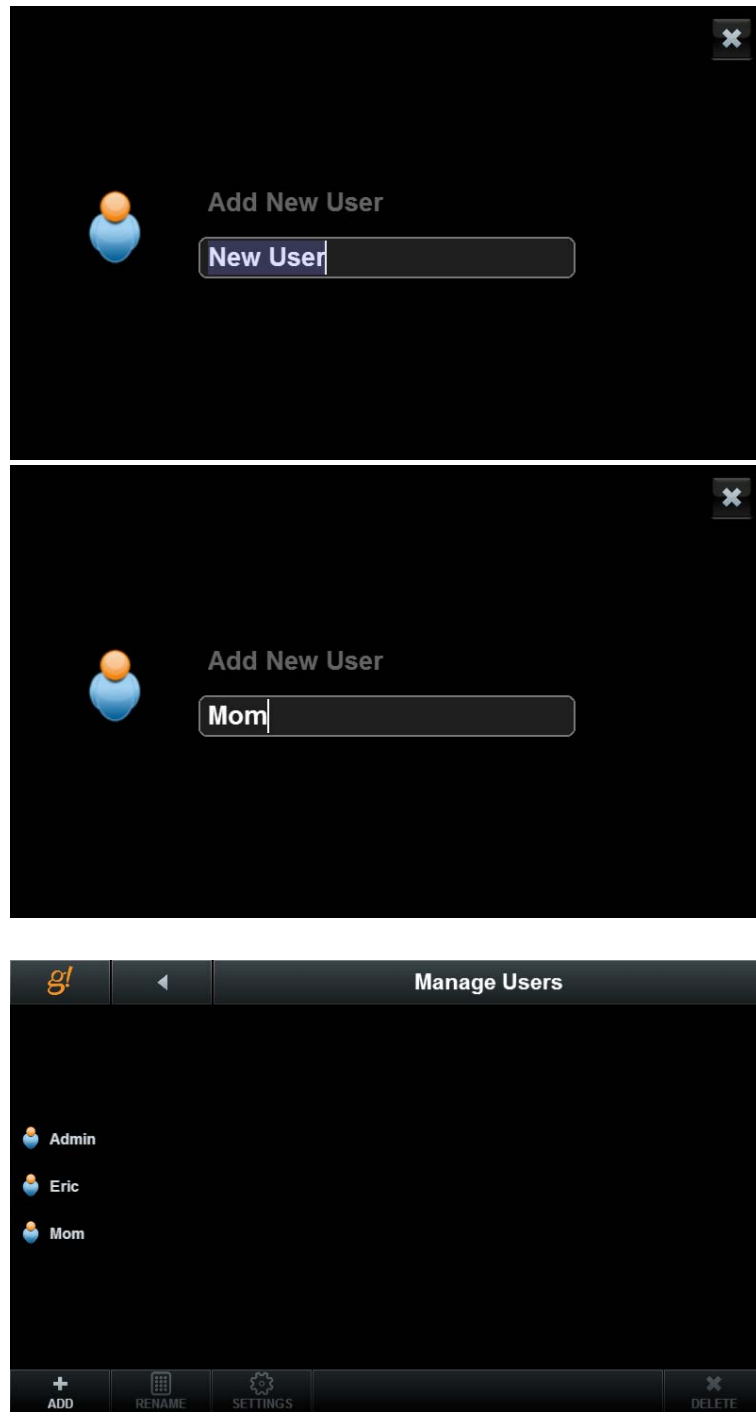

Select the new user (Mom) and then click the **Settings** button.

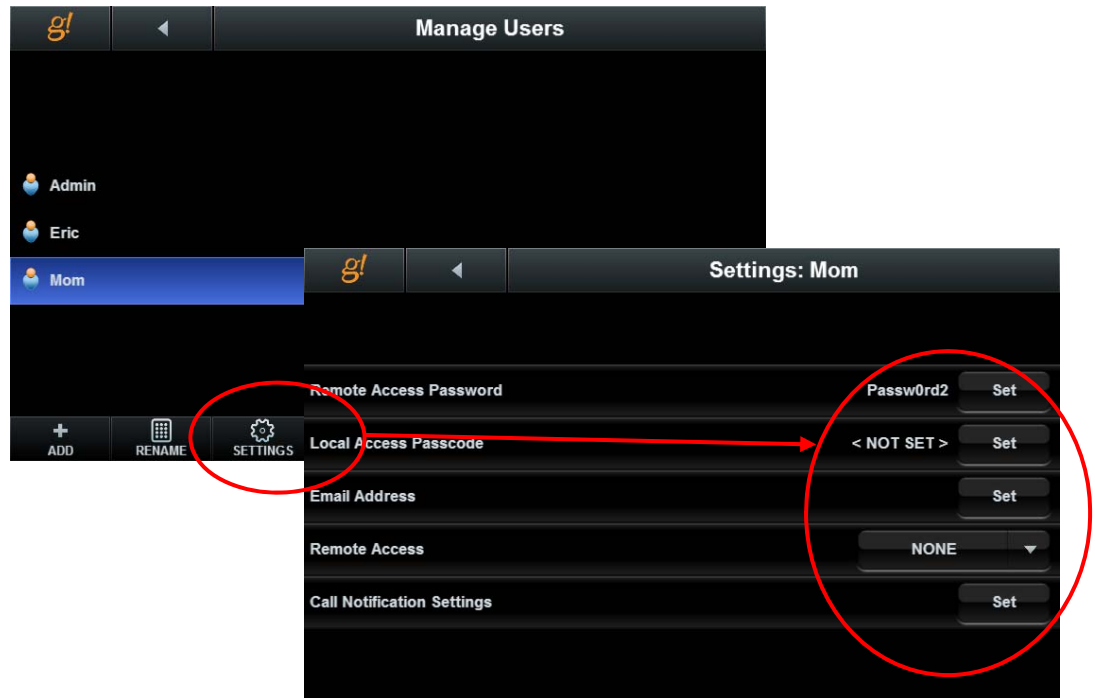

Setting	Description
Remote Access Password	Click the Set button to set an alphanumeric password for the user to enter when accessing the Viewer from a remote location.
Local Access Password	Click the Set button to enter a four digit PIN code for the user to access door locks and local ELAN touch screens.
Email Address	Enter an email address that can be used for system alerts.
Remote Access	Click the arrow and then select one from the list: <ul style="list-style-type: none"> • None- user has no access. • Viewer- user has access to Viewer. • Programming- user has access to Configurator. • All- use has access to both Viewer and Configurator.
Call Notification Settings Requires gMOD, USB to Phone Modem:	
Note: Call Notification Features are not available on the g1 controller.	
Phone Number	Enter a phone number that can be used for system alerts. Enter the phone number as it should be dialed, including any prefix or area code information. Do not use punctuation such as dashes or parentheses.
Acknowledge Stops Alert Calls	Prompts for the contact to acknowledge receipt, so the Controller will stop attempting calls for this alert. Select Yes or No.
Number of Call Attempt	Set the number of times that the Controller should attempt to call this contact with the alert message.



Exercise 5: Working with Touch Screen Settings

Overview The Touch Screen Settings page is used to setup secure access by user for each of the touch screen Viewer interfaces—such as the gTP7, TS7, TS10 and Valet 10—that are configured for the system. On this page, enable or disable the secure access function, and allow or deny access to each touch screen by user.

How-to

1. From the Settings page in the Viewer, select **Touch Screen Settings**. The Touch Screen Settings page displays a list of the touch screens that have been configured for the system.

Note: Be sure to name the touch screens something descriptive so they are easy to distinguish in the Viewer. This is done on the Interface tab, Interface Devices node.



2. Use the table below to set the security for each touch screen in the system.

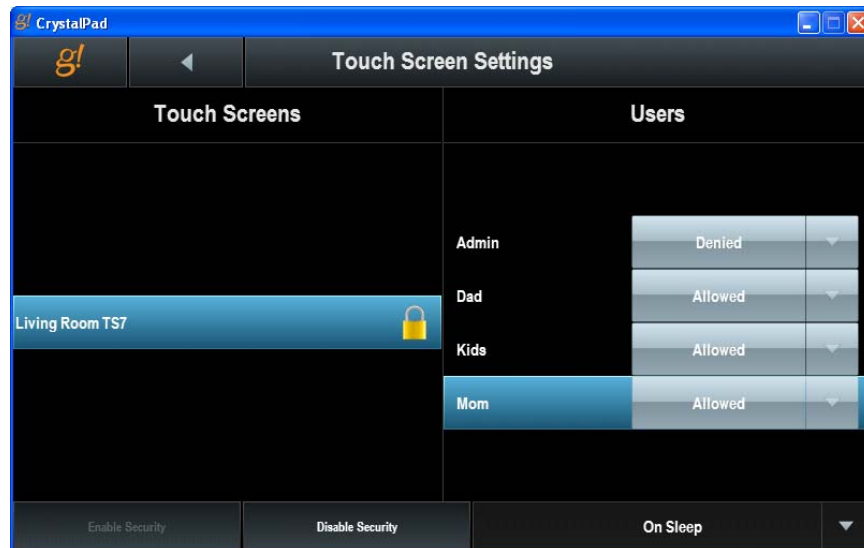

Touch Screen Settings Quick Reference	
Touch Screens	This column lists the touch screen panels that have been configured for the system.
Users	<p>This column lists the users that have been set up for the system. For each touch screen/user, click the arrow and select one:</p> <p>Denied- user cannot use the selected touch screen.</p> <p>Allowed- user will enter their Local Access PIN to use the selected touch screen. Each user that is given secured access to a screen MUST have a Local Access Code set up on their User Settings page.</p> <p>Note: If no users are allowed or no users with an access code are allowed, there's not going to be any way to unlock the screen.</p>
Enable Security	Select to "turn on" the security settings specified in the touch screen/user columns. Appears as grayed out when selected.
Disable Security	Select to "turn off" the security settings. Anyone will be able to access the touch screens without entering a Local Access PIN code.
Lockout Timer	Select the duration of time after which the touch screen should lock. "On Sleep" will cause the touchscreen to lock when it goes into screen-saver mode, or the screen is powered off. This is the default setting.

Exercise 6: Localization (Translating the Viewer)

Overview In Exercise 4, you will import an XML-based language file to change the language version of the Viewer from English to the language appropriate for your customer, with custom editing of the Configurator. The language of the Configurator does not change from English, and the dealer should be comfortable using an English language-based Configurator.

After you import the language file and open the Viewer, the majority of the text fields will be translated. However, some text that is copied from outside sources such as the Internet, any metadata, or third party sources may not be translated. For those areas that are not translated, or the translated words are not correct for that country (for example, Canada and France may use different French words for the same English word), you can custom edit lines of text within the Configurator. If you do any custom editing, then you must export the language file before closing the App to save those changes. You can save the file to a local directory on your PC.

The **Reset (English)** button reverts the language settings to the default, and any custom edits are lost unless the language file is exported before selecting **Reset (English)**.

See the Language library in g!Tools for the list of pre-translated language files that are currently available.

Note: Importing a language file and any language edits should be done early in the configuration process. Certain functions such as custom tabs or lighting keypads are translated as they are added to the Configurator and will not be translated if they are added prior to importing the language file. Be sure to export any changes to g!Tools to save them.

How-to

1. Navigate to the **System** tab, and then select **Language** in the System Node Tree.

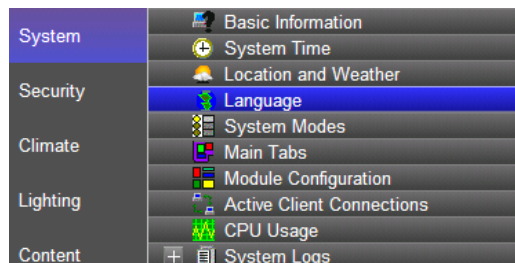

2. Click the **Import** button to open the g!Tools language library folder.
3. Select a language from the list of XML files such as **g_french.xml** and click **Open**. The text under the Translated column of the Configurator converts to French. Click **Apply**.

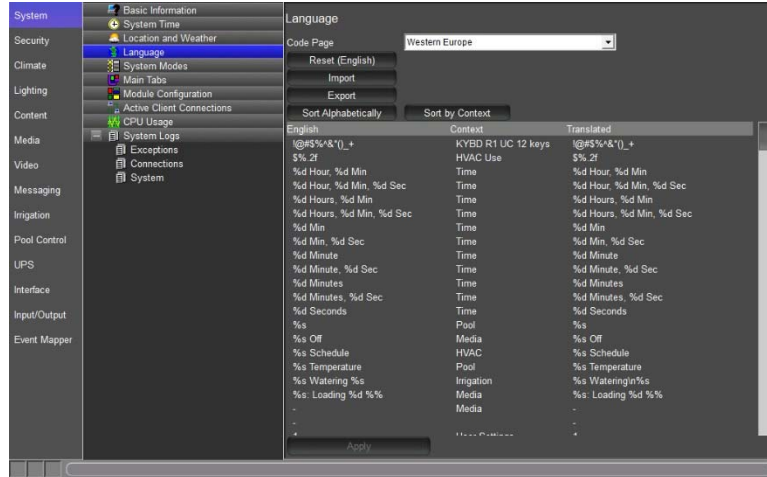

Language Feature Quick Reference	
Code Page	Typically, this field will automatically select the correct setting following the import of a language file. If it does not, then select the correct character font base for the touchscreen. Verify that the character set matches the language being used.
Reset (English) button	Click to reset the translated text to English. Note: Any changes to the Configurator that are not exported are lost.
Import button	Click to launch the file explorer program to locate a language XML file to import. Any changes to the Configurator that are not exported will be lost.
Export button	Click to launch the file explorer program to export any changes to the Configurator as an XML file. You must export the XML file to save any changes made to the language file. The exported file can be imported into any compatible g! system.
Sort Alphabetically button	Click to sort the columns alphabetically. The column sorts based on the English-language column.
Sort by Context button	Click to sort the columns alphabetically by context based on the English-language column.
Language Editor Reference	
English (non-editable field)	The default English text shown in the Viewer and Configurator.

Context (non-editable field)	The default English text shown in the Viewer and Configurator for subsystems or area.
Translated (editable field)	The translated text shown in the Viewer and Configurator. The Translated column can be customized. Click the field to select the text and enter any changes. Note that special characters in this column may be important and should not be edited. Note: Any changes to the Configurator that are not exported will be lost.
Special Characters in the Language Editor	
Variable characters	Some lines of text include special characters in the g! software. These characters, typically a percent symbol (%) followed by a single letter, are dynamic data (for example, the current temperature reading), and will be inserted automatically in that location. In all cases, these variable characters and their spacing must be preserved for proper function. Example: %s

1. To edit a line of text, select the line you want to edit, and revise the text under the Translated column.
2. Click **Apply**.
3. Open the Viewer and the text will display in the imported language. The following example shows the new screen when the translation is complete.
 - The Viewer translated into French.

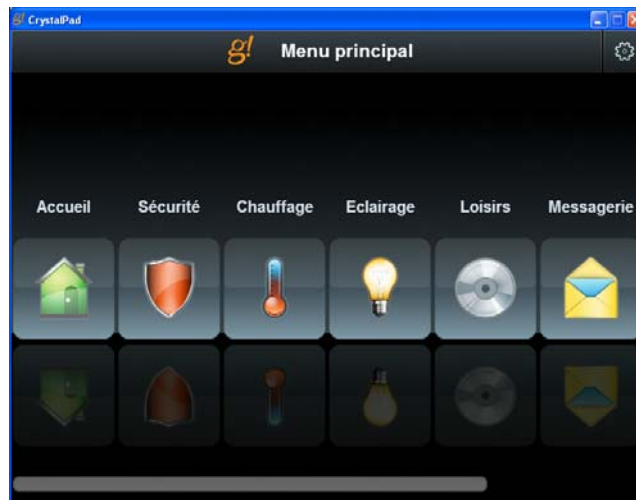

Note: Some items are translated outside the language file line such as zone and source names, and system modes.

4. To export the XML language file, follow these steps:
 - a. Click the **Export** button located on the **Language** tab in the Configurator.

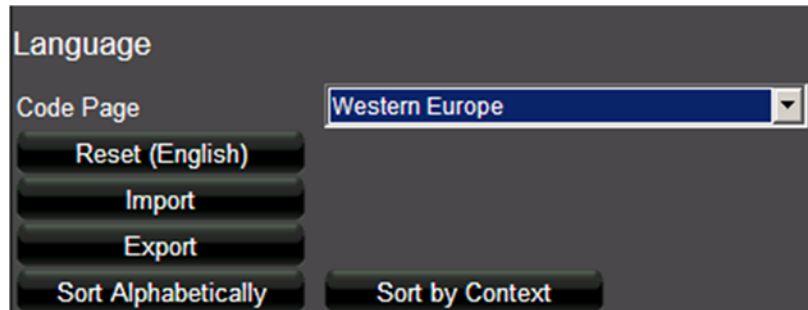

- b. Rename the file and save it to a local directory.

Note: Be sure to retain the .xml extension on the file; it is required when you reimport the file into the Configurator.

Exercise 7: Backing up the System

Overview In Exercise 7, you will create a backup of the current configuration, and learn when to use the different types of backup. Backup files can be created on-site or remotely; but on-site is recommended. Remote backups take significantly longer, and are more likely to be interrupted due to connection problems. Keep in mind that performing any backup operation essentially shuts down the system so that it can copy files that might otherwise be in use. This might interrupt customer use of the system.

Note: Many of the components can be backed up individually. Right-click on items in the Configurator to display the Import/Export function which is available for components such as Custom Tabs, Display Settings, TV Channel Favorites and IR Devices. Import/export can be very useful for copying and backing up the settings of devices or settings you use frequently.

- How-to*
1. Click the **System** tab in Configurator, if you are not already on it.
 2. Right-click the **Basic Information** node at the top of the System Node Tree. A selection menu appears.

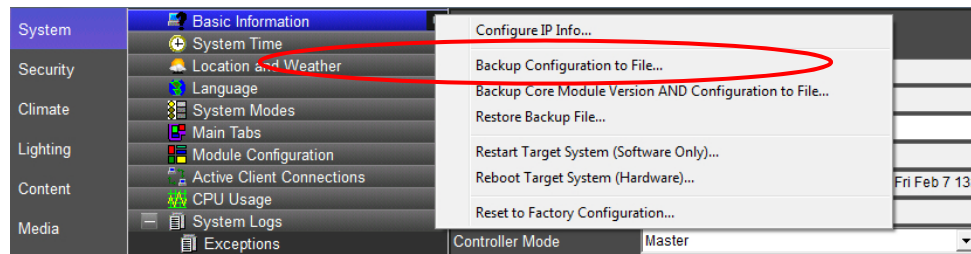

Quick Reference	
Configure IP Info	View/edit the current IP Settings of the ELAN Controller. Note: clicking OK in the IP Settings dialog ALWAYS results in a hardware reboot. If you make no changes remember to click Cancel.
Backup Configuration to File	Create a System Configuration backup file that contains all relevant system configuration data. This type of backup file is used to restore the original system or another system; which is important in the unlikely event of controller failure. This type of backup does not change the software version on the g! System Controller and can be used on the same version or newer. Note: The backup will not include pictures.

<i>Quick Reference, continued</i>	
Backup Core Module Version AND Configuration to File	<p>Create a System Version and Configuration backup file to back up the current controller System Version and Configurator Configuration data files.</p> <p>Note: This complete backup occurs automatically during the update process when using g! version 6.2 or higher. It is offered as a menu item for cases when you want to back up the full system without updating to a newer version. For example, if the user has made numerous configuration changes and wants to capture a complete backup of the new state of the system.</p> <p>For g! versions below 6.2, only configuration information is backed up.</p>
Restore Backup File	Restore a previously created controller Configuration or controller System Version and Configuration backup to the g! System Controller.
Restart Target System (Software Only)	Restart the g! software on an ELAN Controller.
Reboot Target System (Hardware)	Perform a full hardware reboot of the ELAN Controller.
Reset to Factory Configuration	Remove all configuration and software updates.

3. ELAN Controller Configuration Backup: Select Backup Configuration to File...
A window will pop up asking you to continue. Please note which items will not be backed up in the pop up window.

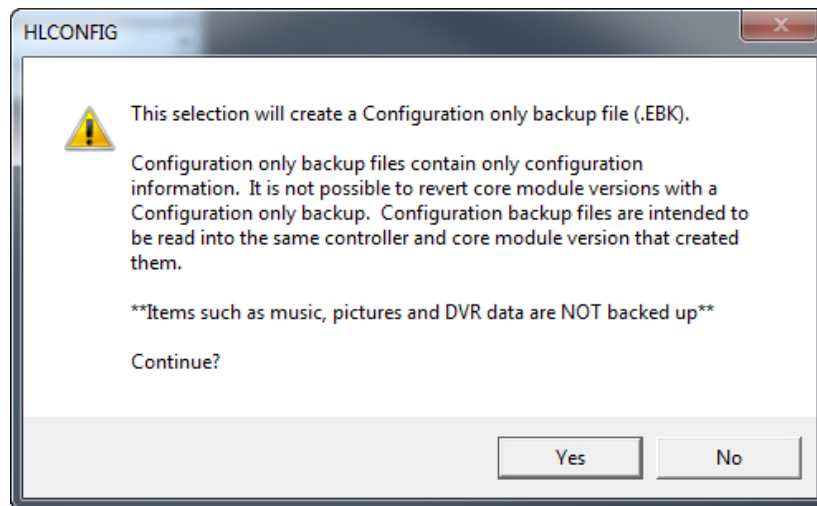

4. Select “Yes” to continue with the Configuration File backup. A pop up window will prompt you to choose a save location and file name.

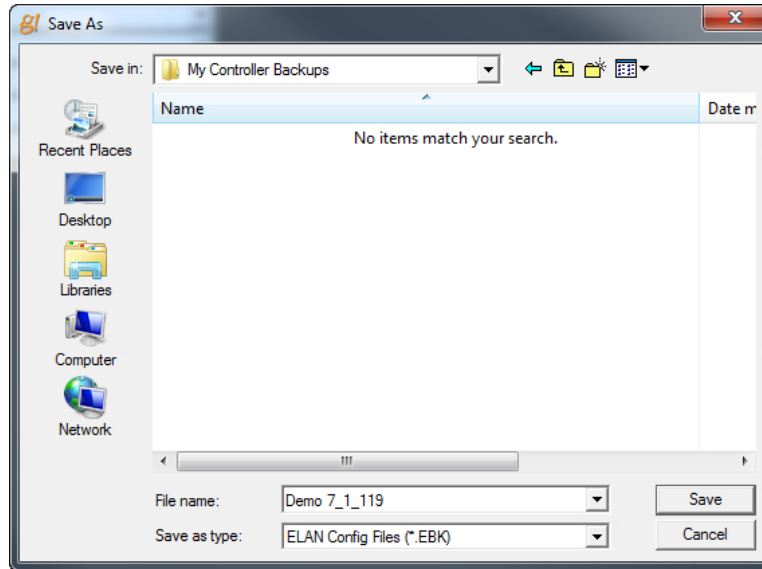

Notes about Backup Files:

The backup file name should be descriptive, and should include the date, system name, and core module version number. ELAN recommends that you create a new file for each backup, rather than continuously overwriting the same file.

5. Navigate to a directory for the backup, enter a name for the backup file, and click **Save**. *The system will now open a Backup/Restore window and should quickly populate the list of files to backup. A red bar will also draw across the bottom of the Configurator window indicating System Exit progress.*

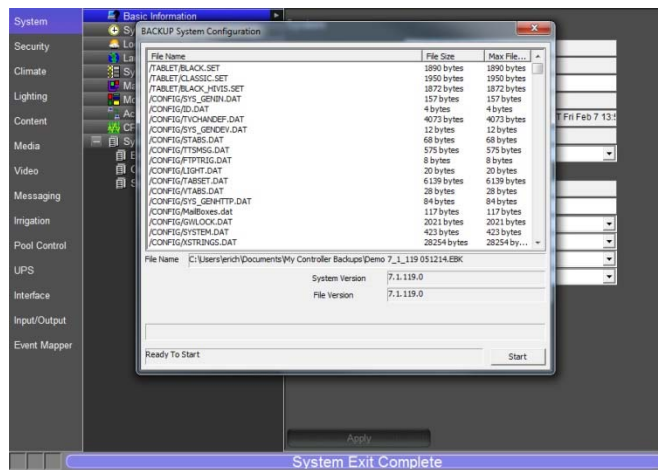

6. When the data gathering process is complete and files have fully populated the Backup/Restore window (usually a few seconds), click **Start**.

7. Wait a moment while the backup completes. *During backup, you will see the files color as they are completed and blue progress bar will draw along the bottom indicating the progress of each file. When file backup is complete, verify that the status line on the bottom indicates **Backup Successful**.*

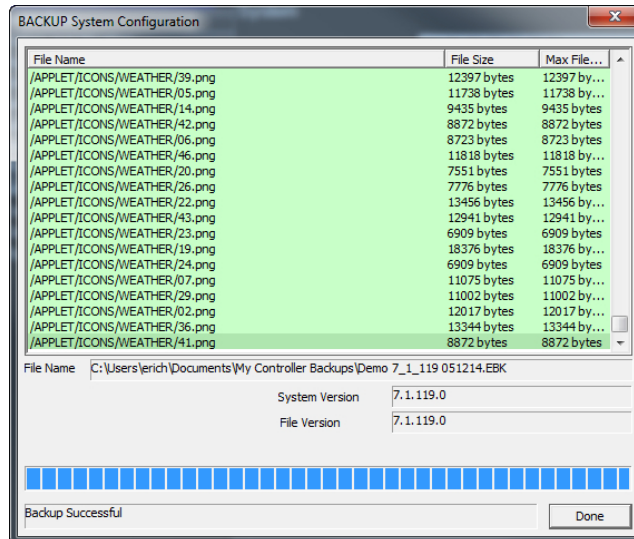

8. Click **Done** to exit the *backup* dialog.

Lesson 3

Configuring Security Systems



Overview

In this lesson, you will configure a security system.

You will:

- Learn how security systems are organized in the Configurator.
- Use the Configurator to set up communication for the panel, add the panel in the configurator, and detect partitions and zones for the security system.
- Check the Viewer to confirm proper configuration.
- Understand the various features available in the Viewer.
- Use the Configurator to set up wireless door locks.
- Use the Viewer to manage users and permissions for the wireless locks.
- Use the Viewer to operate the wireless locks.

Sample House

Our sample house and attached garage will be configured as two partitions, and feature 4 wireless door locks:

- House containing four zones.
- Garage containing two zones.
- 4 wireless door locks

Requirements

- g! system controller and g!Tools.

Security Integration Overview

Overview The following diagram shows the sample house security system schematically, illustrating the components that are important to the g! system controller.

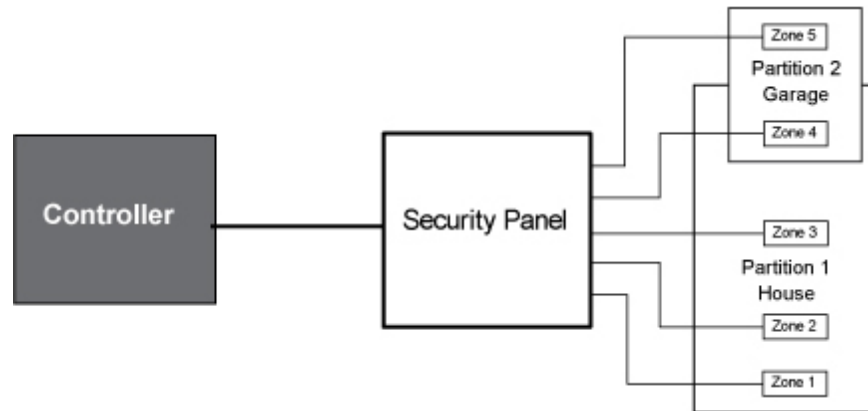

Integrating the security panel with g! software provides the homeowner access to their security system through the g! Viewer. For each security partition in their home, they can:

- Arm and Disarm the system.
- View partition and zone status and optionally bypass faulted zones.
- Review zone fault and armed status history.
- Use security panels and sensors with the g! Event Mapper to provide additional automated functionality.

Terms

The following terms are used in the Configurator:

- **Communication Device:** The method the g! software uses to communicate with an external device, including information about the connection type and protocol. In the overview diagram, the communication device is one of the built-in COM ports on the ELAN controller.
- **Security Panel:** The actual security controller.
- **Partition (Area):** A group of zones in a security panel. Typical partitions include **Whole House** and **Garage**, as in the previous example. Note that some zones (like a door from the house into the garage) may appear in two different partitions.
- **Zone:** An individual sensor in the system, such as **Front Door**, **First Floor Motion**, etc.

How-to

To integrate a security system:

- Add the **Communication Device**
- Add the **Security Panel**
- **Discover Devices** installed on the security panel
- Check the **Viewer** interface

Once the security panel is added, the g! software can (in most cases) import all the zone and partition information from the panel. This occurs in the Configurator using the **Discover Devices** feature on the security panel's Properties window. In those cases, the security system configuration is complete once you verify that zone and partition information appears in the system tree.

Exercise 1: Add the Communication Device

Overview In this exercise you will add a **Communication Device**, which is the bridge between the g! software and the Security Panel; and where you specify how the systems are physically connected and what communication protocol should be used.

Note: Actual system setup may be different depending upon which Security panel is installed on site. Refer to the *Integration Notes* for the particular panel for details.

How-to

1. Start the Configurator, click the **Security** tab at left, and then click **Communication Devices**.



2. Right-click **Communication Device** and select **Add New Communication Device**. In the dialog box, configure the settings as shown for a standard serial port, and click **OK**.

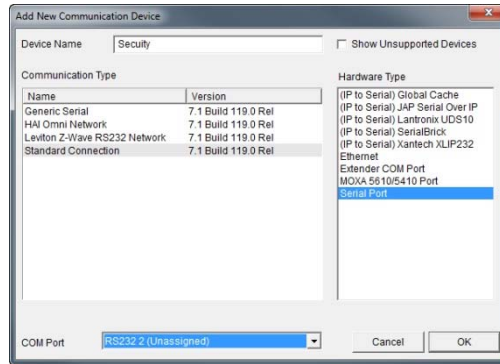

Quick Reference: Add New Communication Device	
Device Name	Enter a name for the external device. This can be any name, but should be descriptive so that you can identify this specific device in the Configurator. DO NOT leave this field set to "New Device".
Show unsupported devices	Select this checkbox to display legacy devices on the Device dropdown list. Legacy devices have not been tested with the current version of g! and are no longer supported by ELAN. If you choose to install an unsupported device, a message will display to warn that the device is not supported by ELAN technical support.
Communication Type	This is the protocol of the communication. See the <i>Integration Note</i> for the specific security panel for more information.
Hardware Type	The type of connection you are using, such as serial port or Ethernet.
Device	This drop down will populate with the appropriate device for the selected Hardware Type. I.E. When Serial Port Hardware Type is selected the Device dropdown changes to COM Port.

3. Select the **Security** device in the system tree.

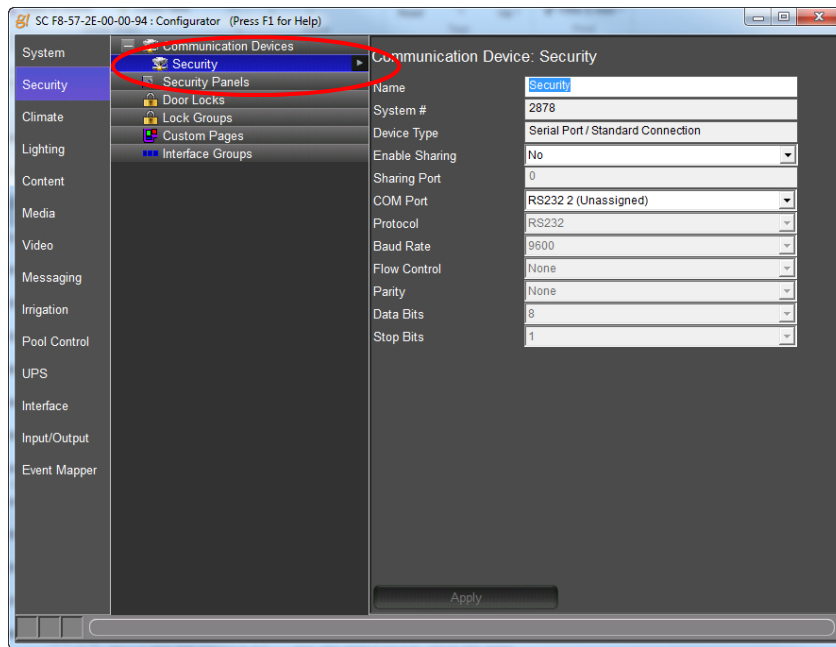

4. In the properties window at right, verify the COM Port selected is correct.

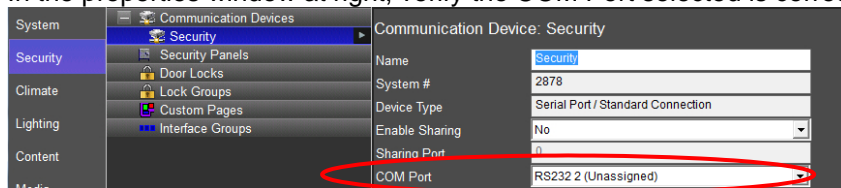

Exercise 2: Add the Security Panel

Overview At this point the **Communication Device** is configured, and the security panel can be added.

Note: Actual system setup may be different depending upon which Security panel is installed on site. Refer to the *Integration Notes* for the particular panel for details.

How-to

1. In the Configurator, right-click **Security Panels**, then click **Add New Device**.
2. In the **Add New Device** dialog box, select **Virtual Security Controller**, and then click **OK**.

This adds a new security panel, and also automatically connects the panel to the Communication Device added in the last exercise.

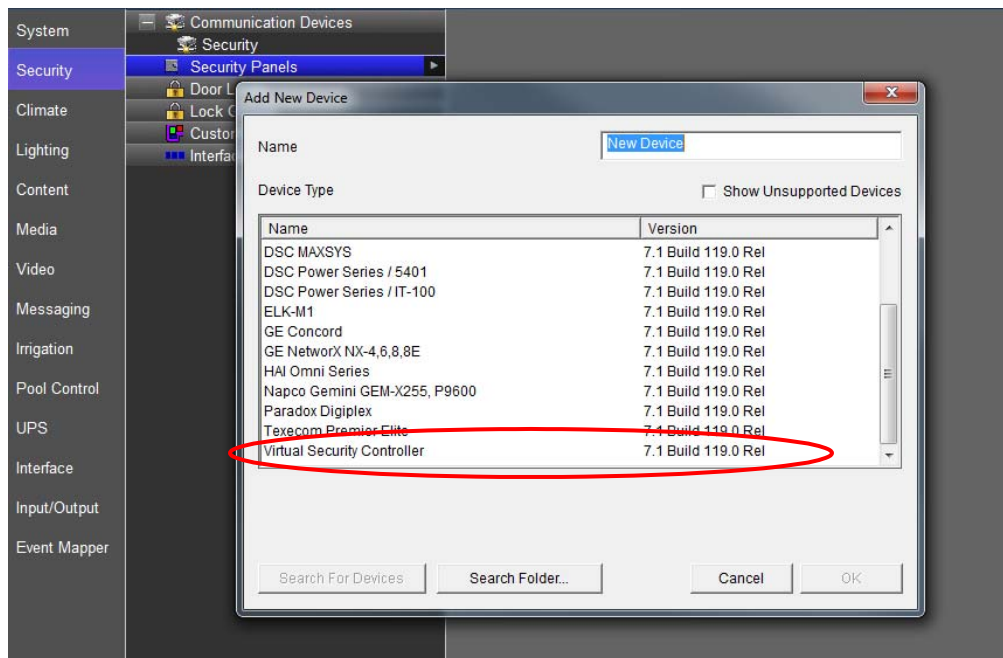

3. Select the new security panel in the Configurator.
The properties for that panel display on the right.

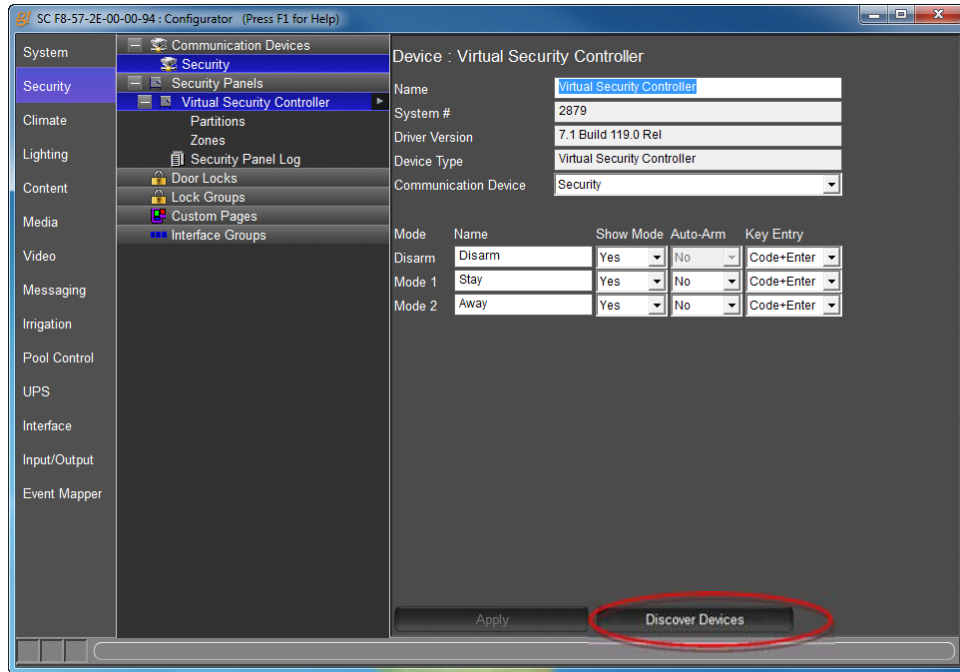

4. Click the **Discover Devices** button at the bottom of the window.

The Configurator queries the security panel to read the partitions and zones from the hardware. This configuration is then displayed in the system tree. The virtual Security simulates a response.

Quick Reference: Security Controller Properties	
Mode	A “state” that the security system can be in. Typically each mode will provide a different level of security.
Name	A name for the mode, such as “disarm” or “away”. This is the name that will appear on the mode’s button in the Viewer.
Show Mode	Select Yes or No to display or hide a button for this mode in the Viewer.
Auto-Arm	Select whether this mode is “auto-armed”- that is, the panel is armed without entering a security code when this mode is selected.
Key Entry	The format for entering the security code on the Viewer keypad.

In the following screen, the two partitions -House and Garage- were discovered. Each partition has zones associated with it. When you click on a partition, its zones are highlighted in blue.

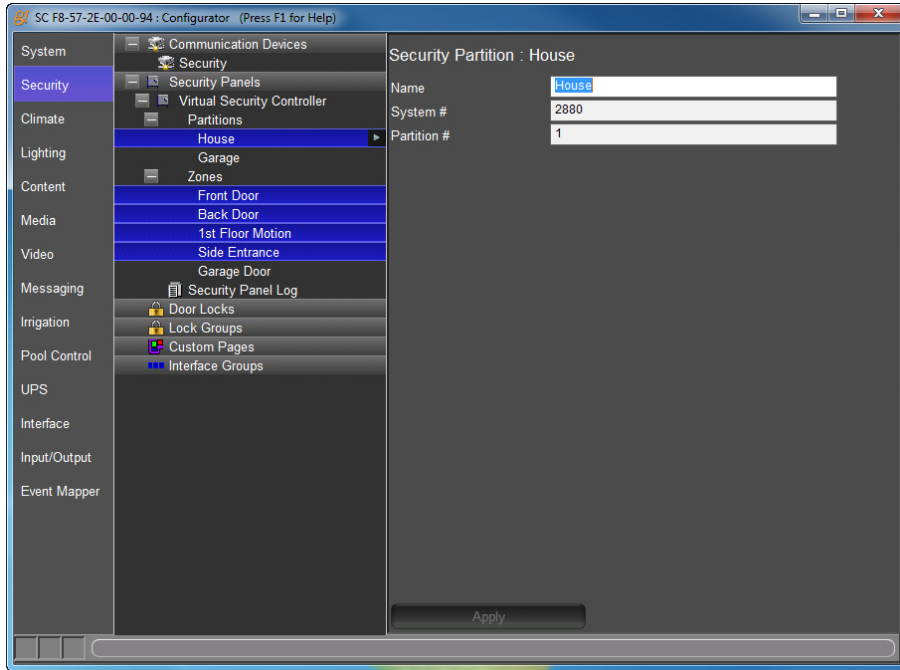

Exercise 3: Check the Viewer

Overview At this point the security panel has been added and set to communicate with the g! system controller. You should now check the **Viewer** to verify that the setup displays properly.

How-to

1. Minimize the Configurator so that the Windows desktop is visible.
2. From the g!Tools **My Systems** screen, click the **Viewer** button. The viewer starts and displays the **Main Menu** page.
3. Select the **Security** icon to display the configured security partitions.



Note: On this screen you can view the status of all the visible partitions.

4. Click on the House partition icon to access House partition screen. In the example below, you can see:
 - The system is Ready to Arm.
 - There are no System Faults (such as low battery)
 - There are no Bypassed Zones.
 - The “House” partition is displayed in the top center of the screen.



5. Try to Arm the system. Click **Away**, then click **1, 2, 3, 4** and **Enter** in order (this is the default security code for the Virtual Security device). *After a short delay, the display will show **Armed**.*



6. Click on the **History** button at top right. The Viewer will display the system history tab.

Note: Keep in mind that a newly added security panel will have no history to display.

Example

The screen below shows the Security History from a real system.

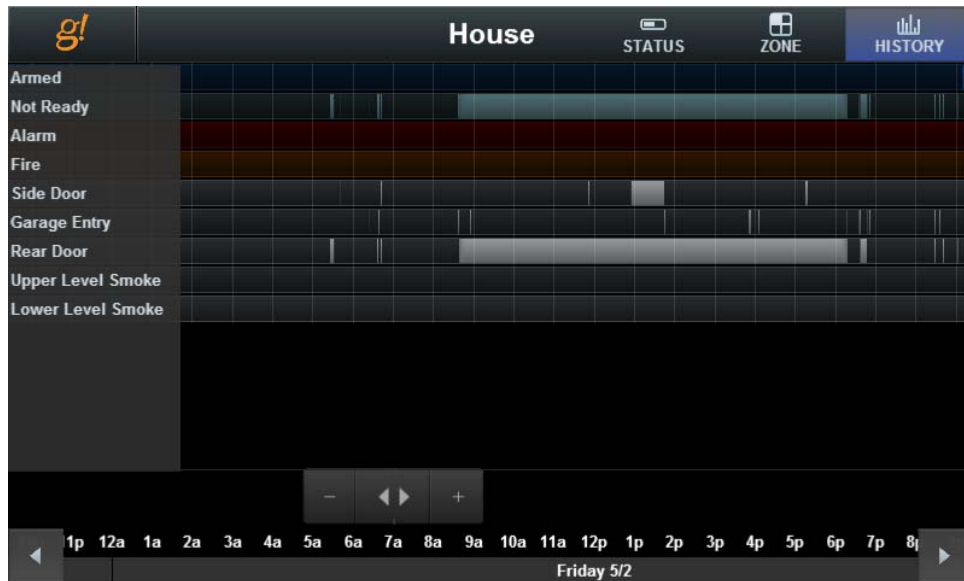

Exercise 4: Configure Wireless Locks

Overview The g! software supports Z-Wave wireless door locks, allowing the homeowner to secure and unsecure their home, check the status of their locks and automate securing/unsecuring based on the house mode. Integrating the locks with g! also allows for event-based configuration using event maps.

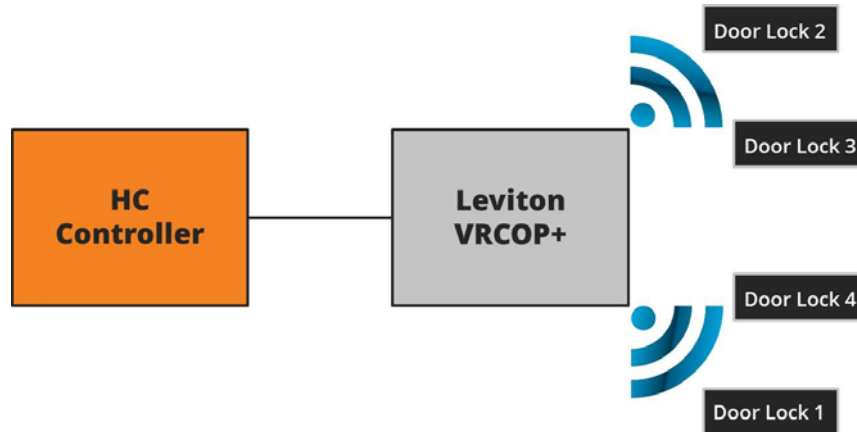

Setup of the wireless door locks using the Z-Wave setup software (http://www.leviton.com/OA_HTML/SectionDisplay.jsp?section=38971&minisite=10251) and the USB to Z-Wave adaptor, VRUSB, must be done prior to adding the compatible door locks into the g! system. Setting up the wireless locks in the g! Configurator occurs in two places; first, in Exercise 4, you will add the locks to Configurator and make them available for display on the Viewer. Second, in Exercise 5, you will finish setting up the door locks in the g! Viewer. In this exercise you will configure several locks, and create a lock group to control multiple locks at one time in the g! Configurator. Exercise 6 will show you how to use the Viewer to secure and unsecure the locks and lock groups.

How-to 1. In Configurator, navigate to the **Security** tab.

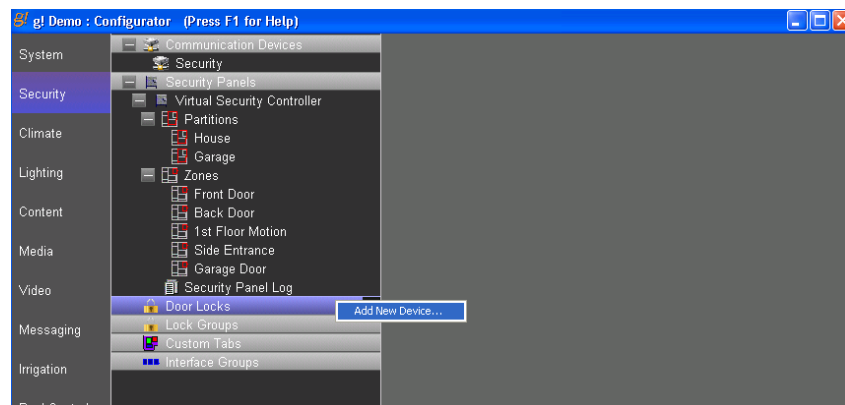

2. Click **Door Locks**, and then click **Add New Device...** The New Device window displays.

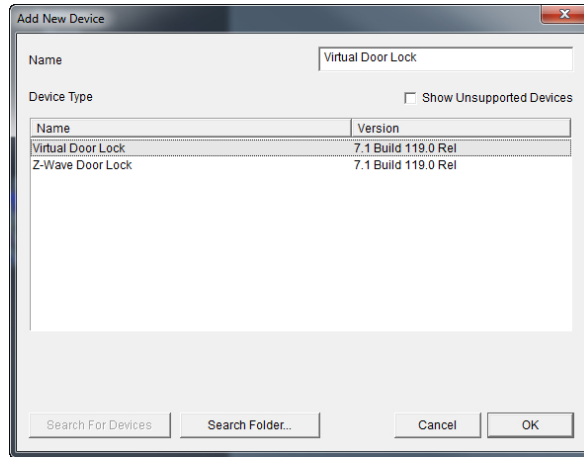

3. Select **Virtual Door Lock**, and then click OK. The virtual lock is added to the list.

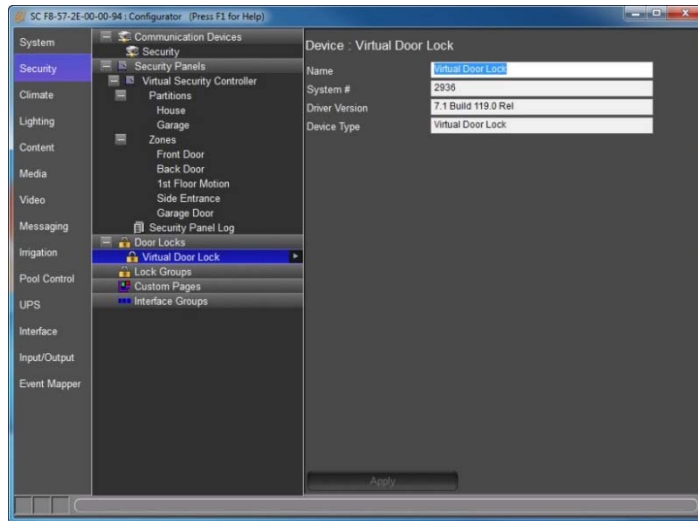

4. Select the virtual lock and rename it to “Front Door” by entering a new name in the Name field in the right pane, and then click Apply.

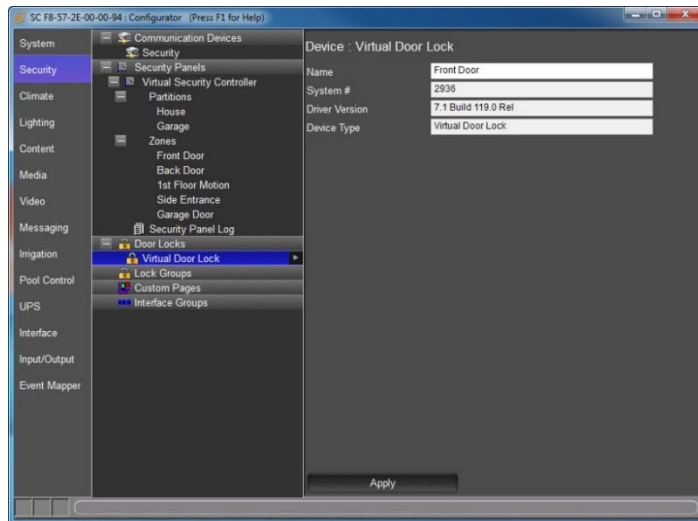

5. Add three more virtual locks, and name them Back Door, Garage, and Wine Cellar.

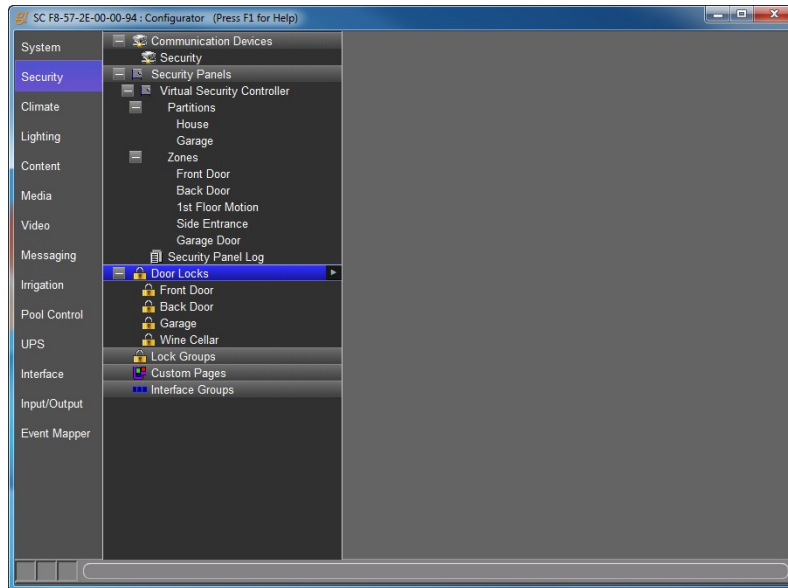

6. Right-click Lock Groups, and select **Add New Lock Group...** Name the group "Side" and select OK. "Side" is added as a Lock Group, and the properties pane displays Available Tabs and Visible Tabs columns.

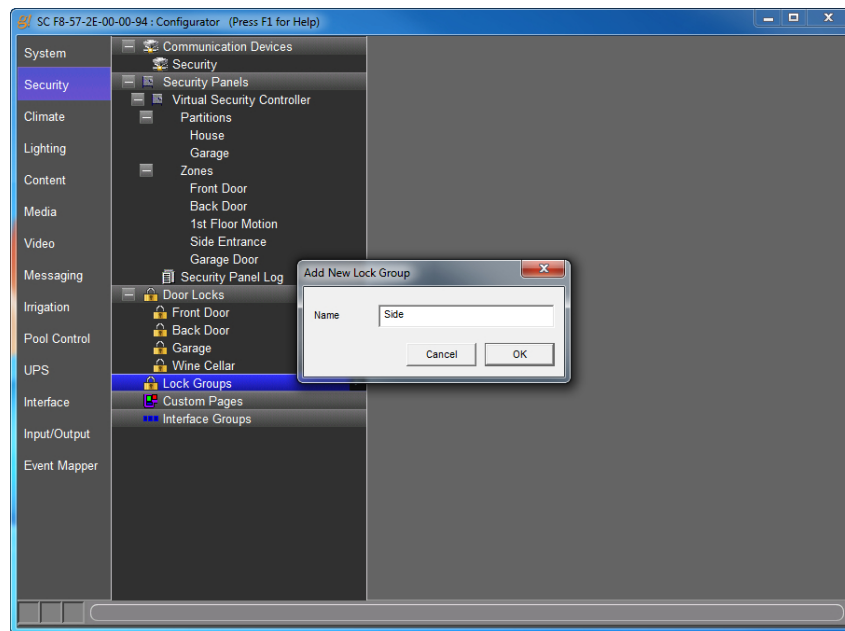

7. Select **Back Door** and **Garage** from the Available Tabs list, then click the **Add Tab>>** button to add these locks to the Visible Tabs list.

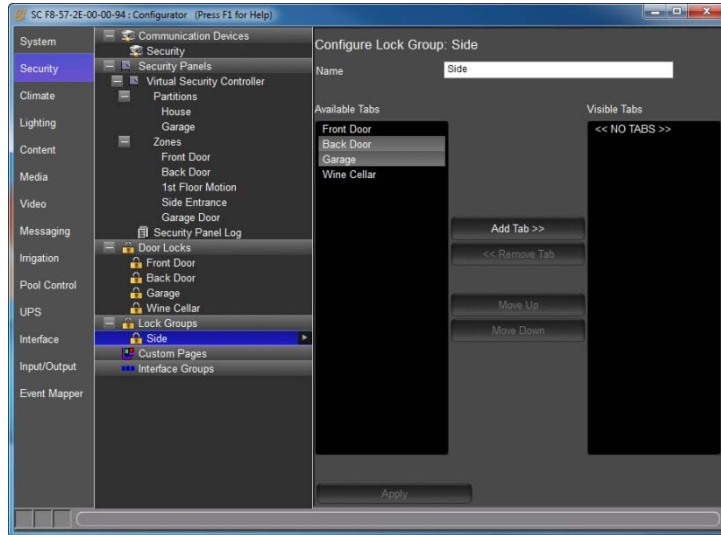

8. Click **Apply**.

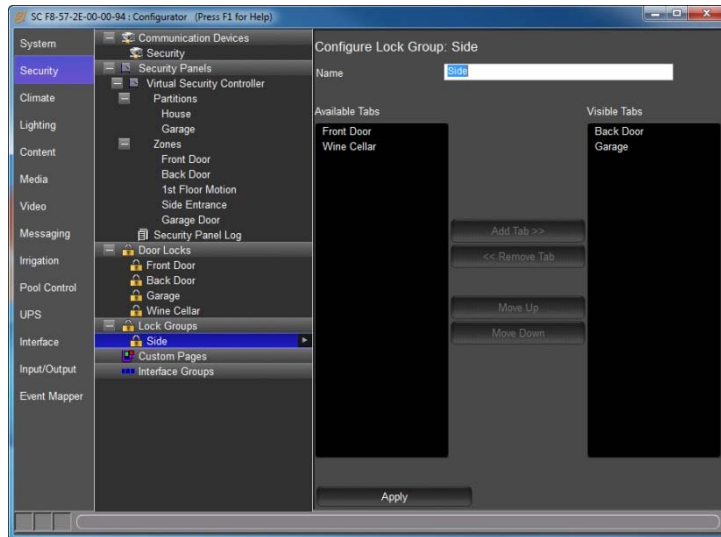

- To make the locks visible in the Viewer, go to the **Interface** tab, and expand the desired interface (in this case, My PC).

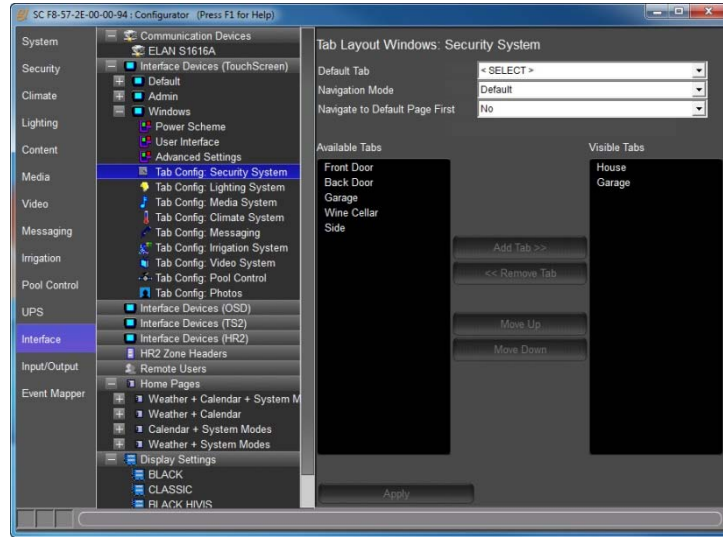

- Select **Tab Config: Security System**. From the Available Tabs list, select Front Door, Wine Cellar and Side, then click **Add Tab>>** to move these to the Visible Tabs list.

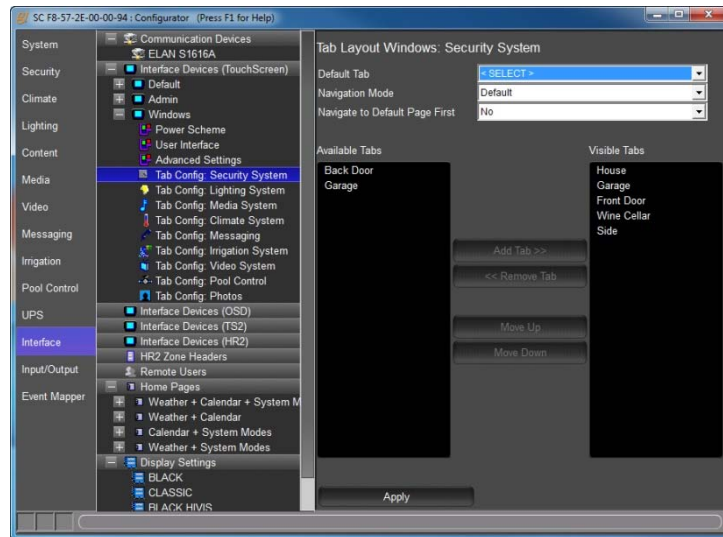

- Click **Apply**.

Exercise 5: Configure Door Lock Settings in the Viewer

Overview The Door Lock Settings page lists all the wireless locks that have been configured for the system, and the system users. Use this page to map the users to a lock slot, and indicate the locks that the user is allowed to access. Then, for each slot/user combination, indicate the permission granted to each lock.

How-to

1. Minimize Configurator and open the Viewer.
2. From the main menu, click the User Settings icon in the upper right corner of the screen. *A keypad displays to enter the passcode.*

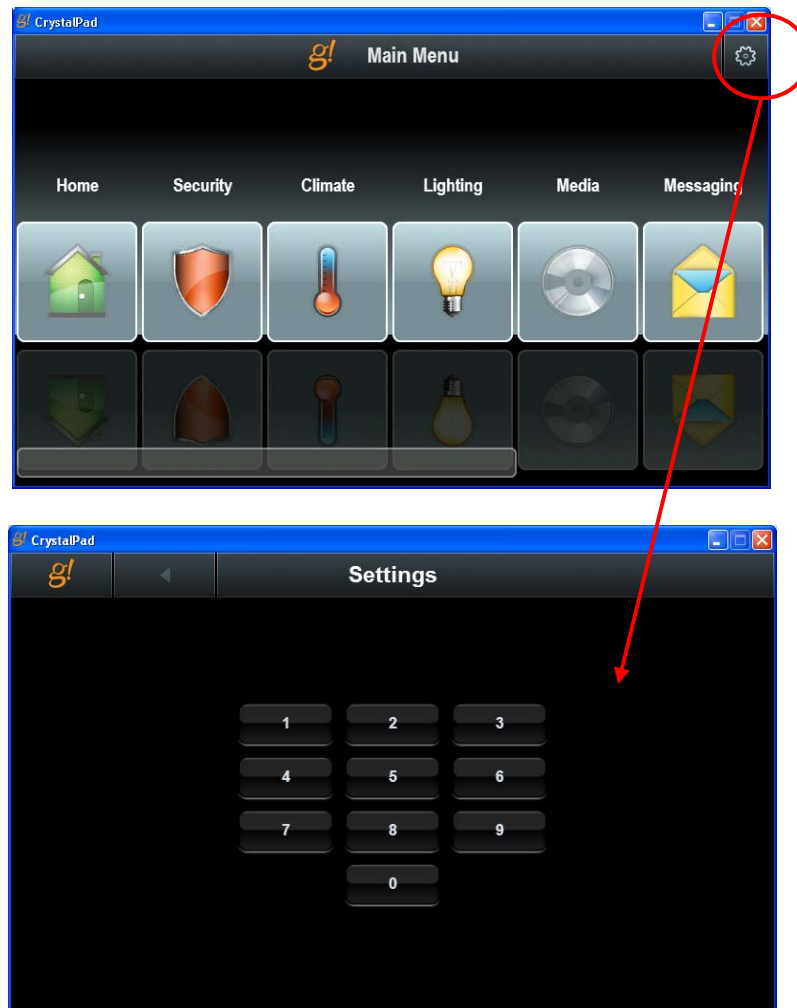

3. Click **1234** on the keypad. *The main User Settings page displays.*

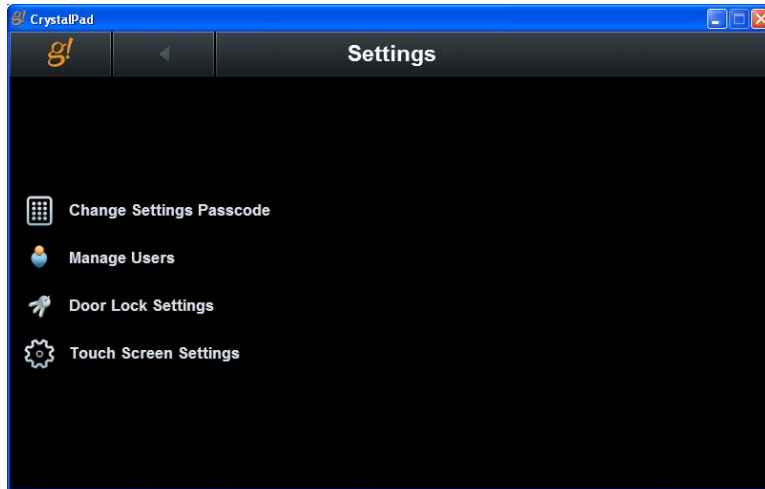

4. Click **Door Locks** on the User Settings main page to display the Door Lock Settings page.

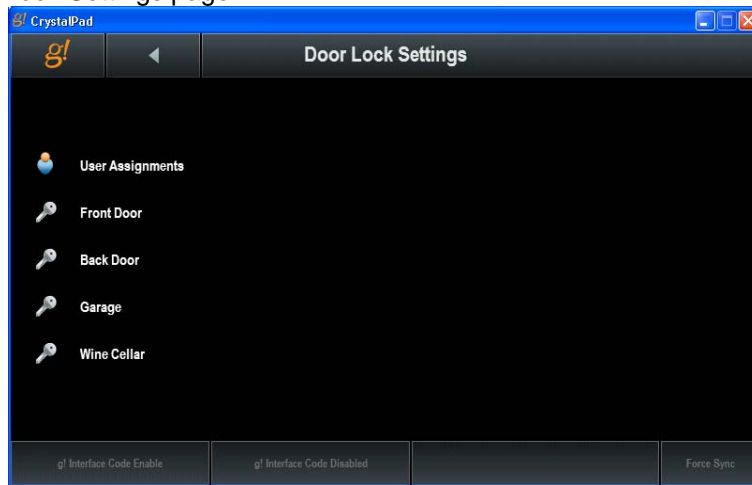

5. Click **User Assignments** to display a list of slots for the door lock system. Note that the slots remain the same for each lock within the system. You will use the User Assignments page to assign each user to a slot number.

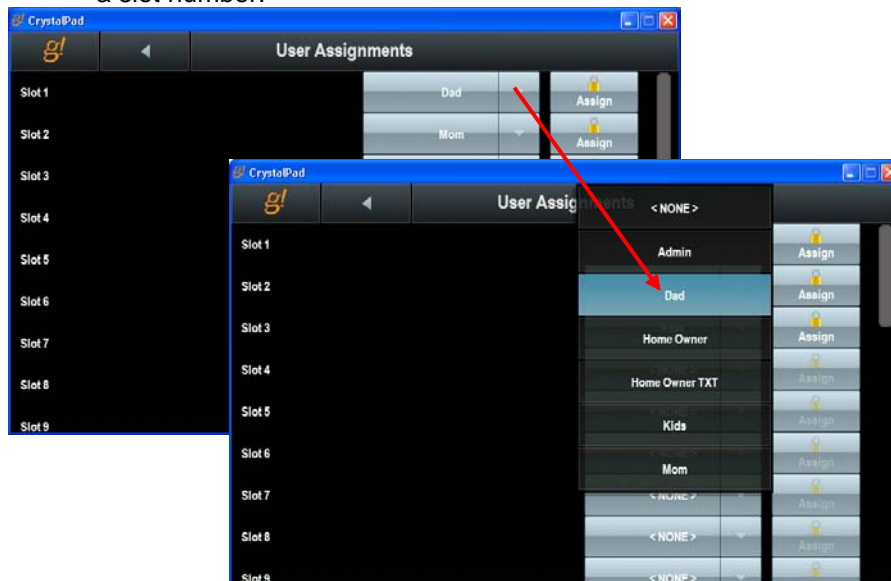

6. Click the **<NONE>** button for **Slot 1** to display the list of users. Select a user from this list to assign to **Slot 1**. Repeat to assign the remaining users to slots.
7. Set Permissions for each slot/user. Click the **Lock icon/Assign** button next to your Slot 1/user assignment (Slot 1/Dad in the screens below) to see the permissions details for that slot. Notice that each lock is displayed on this page.

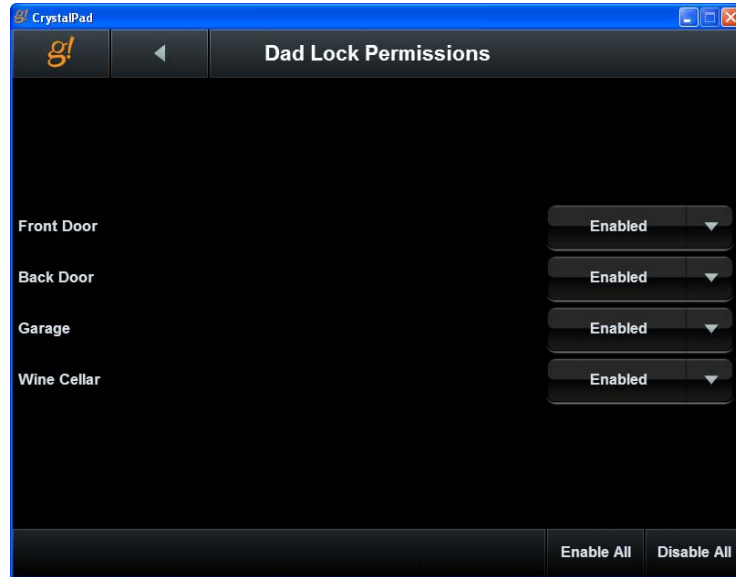

8. For each lock on the Permissions detail page, indicate if the user has permission to access the lock (Enabled) or not (Disabled). Use the buttons at the bottom of the screen to enable or disable all the locks for this user.

This example shows how the “Kids” user was given access to some locks, but not others.

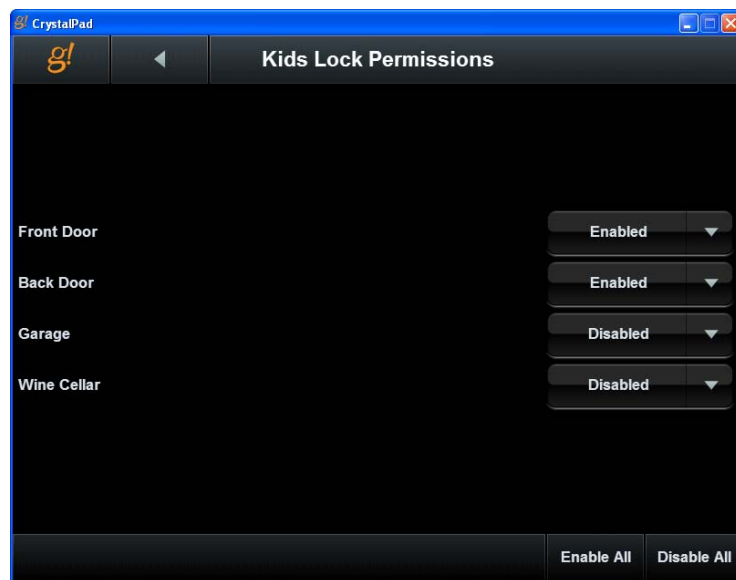

9. Go back to the Door Lock Settings main page.

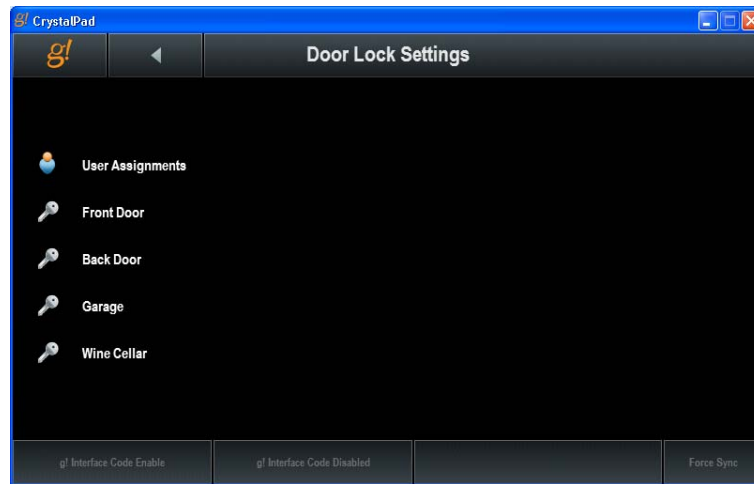

10. Select the **Front Door** lock to highlight the lock and the buttons at the bottom of the screen.

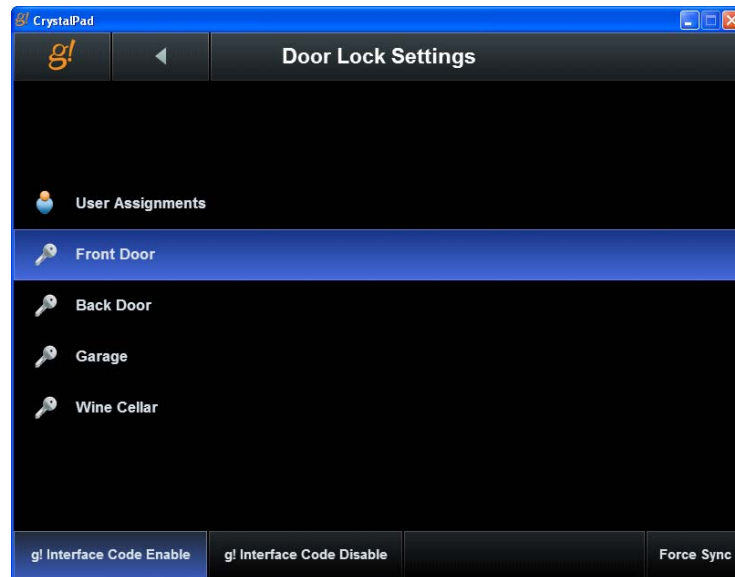

The following options are available for each lock in the system:

- **g! Interface Code Enable.** Select this option to require each user with access to the lock to enter their pass code to unsecure the lock.
- **g! Interface Code Disable.** Select this option to allow the lock to be unsecured without a pass code.
- **Force Sync.** Changes code slots are automatically synchronized in the background. Select this button sync all 30 codes at once.

Exercise 6: Use the Viewer to Secure and Unsecure Wireless Locks

Overview This exercise discusses how to use the Viewer to secure and unsecure the wireless locks that were configured in the previous exercises. The system will allow any user to *secure* the locks; however, a pass code can be optionally be required to unsecure any lock or lock group. See Exercise 5 for information on setting up users and pass codes in the Viewer.

Note: When a pass code is required for any locks within a lock group, the Unsecure All feature for that group will be disabled.

- How-to*
1. Minimize Configurator and open the Viewer.
 2. Click the Security Icon.



3. The All Security page appears. In the screen below, notice that the security partition and wireless locks are all displayed together. It is important to keep in mind that these two systems are not integrated; for example, disarming the security on a door does not unlock it. Also notice:
 - a. Single locks display one key, and an open and closed padlock to secure/unsecure that lock.
 - b. Lock groups display a ring of 3 keys, and Secure All padlock to secure all the locks in that group.

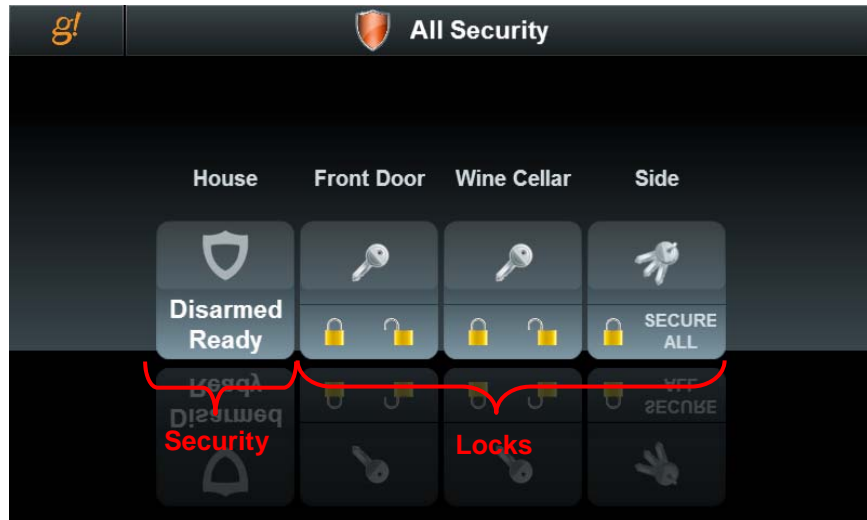

4. Click the closed padlock symbol on the **Front Door** to secure the door. *The system will indicate that it is working, and then the icon will turn blue.*



5. Secure the locks in the **“Side”** group by clicking **Secure All** in the icon.



6. To unlock the **Front Door**, click the unlocked padlock icon. A keypad displays for the user to enter their pass code.
7. Enter 1234. The **Front Door** icon turns gray and the unlocked padlock is highlighted to indicate this lock is unlocked.

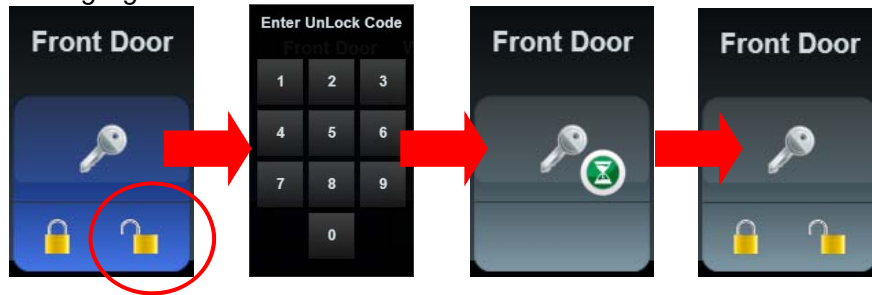

8. To unsecure the Side lock group, select the keys in the icon to open the group.

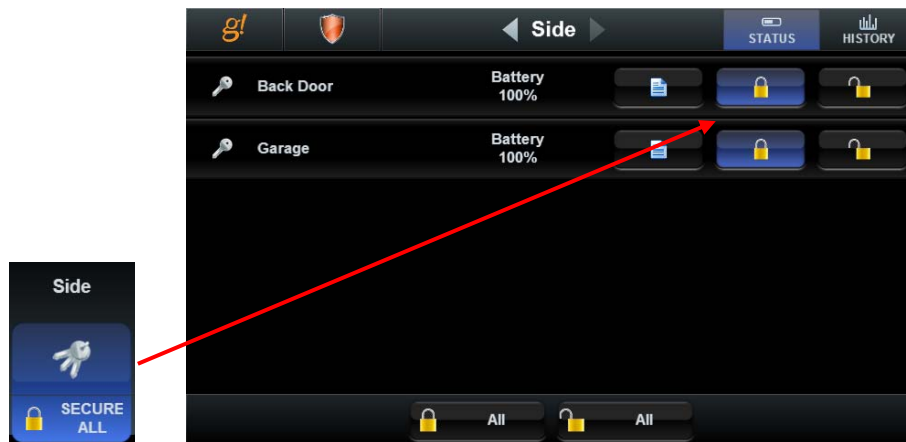

9. Click the **Unsecure** button for the **Back Door** lock. The keypad displays to enter your pass code.
10. Click **1234** on the keypad.
11. Repeat steps 8 and 9 for the **Garage** lock.

Note: Only locks within the group that do not require a g! pass code will operate with the Unsecure All operation. Locks that require a g! pass code to unlock may only be unlocked individually.

Exercise 7: View the Event Log for Wireless Locks

Overview The Viewer provides an Event Log for each configured lock. This log displays the date and time of activity for the lock including secure and unsecure, jams, low battery and other warnings. This exercise discusses how to use the Viewer to access the event log for wireless locks.

How-to

1. To view the event log for a single lock, navigate to the Security page, and click the key in the icon for the lock you want to view. *The details for the lock display.*

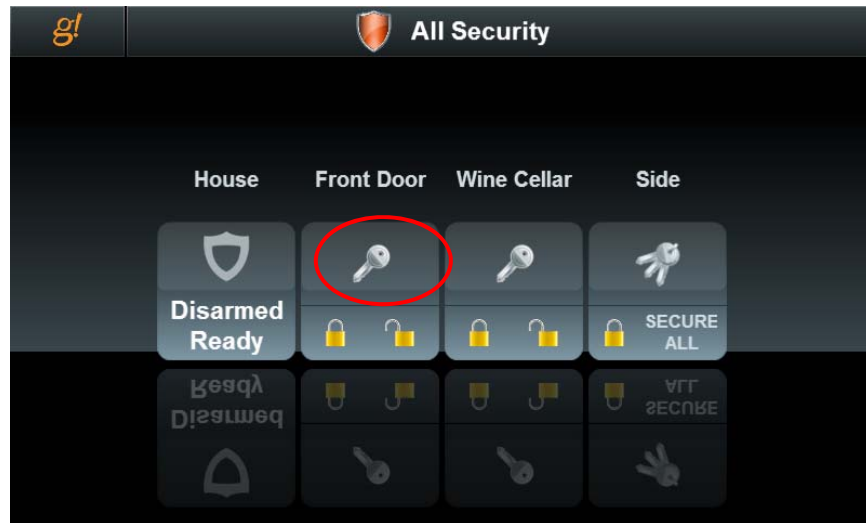

On the details page, you can:

- Secure or unsecure the lock
- See the battery level for the lock
- View the log of events for the lock

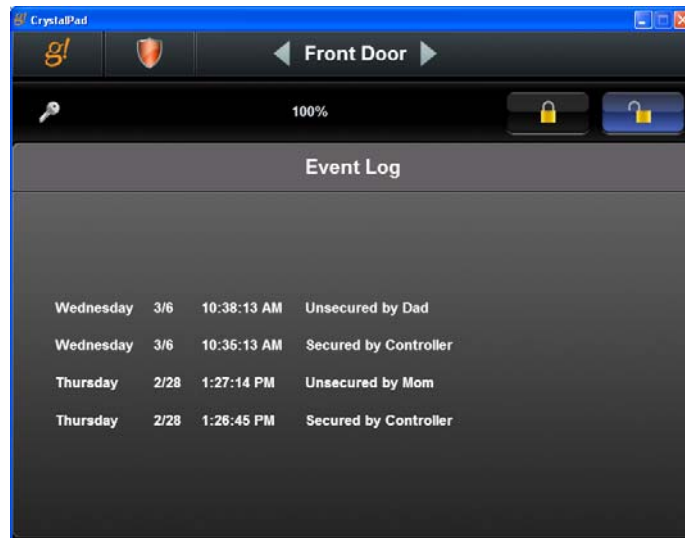

- To view the event log for a group of locks, navigate to the Security page, and click the keys in the icon for the lock group you want to view. *The details for the lock group display.*

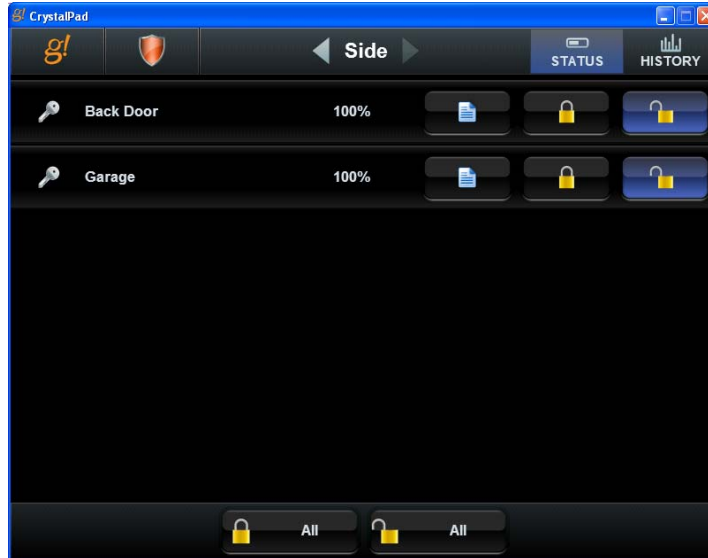

On this detail page, you will see a separate line for each lock within the group. For each lock you can:

	<ul style="list-style-type: none"> See the battery status
	<ul style="list-style-type: none"> Secure or unsecure the lock
	<ul style="list-style-type: none"> Click the Event Log button to view the log for the selected lock.
	<ul style="list-style-type: none"> Use the buttons at the bottom of the page to Secure All or Unsecure All locks within the group with one click. Note that if a lock within the group requires a pass code, the Unsecure All function is not available.

Lesson 4

Configuring Climate Systems



Overview

This lesson shows you how to configure a climate control system.

You will:

- Learn how climate control systems are organized in the Configurator.
- Use the Configurator to setup communication for the thermostats and setup the equipment
- Learn how to set up schedules for the heating and cooling systems.
- Check the Viewer interface to confirm proper configuration
- Understand the various features available in the Viewer.

Sample House

Our sample house and attached garage will be configured with two heating and cooling zones:

- Living Room
- Bedroom

Requirements

- g! system controller and g!Tools.

Climate Integration Overview

Overview The following diagram shows the equipment in a typical climate system schematically, illustrating the components that are important to the g! system controller.

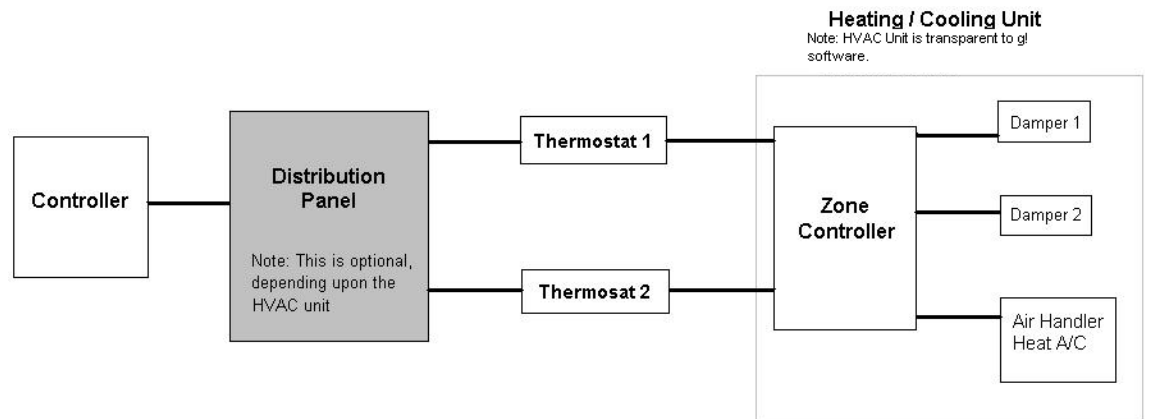

Integrating a climate system with the g! software provides the homeowner access to their climate system through the g! Viewer. For each thermostat in their home, they can:

- Turn on and off the heating and cooling system
- Adjust the heating and cooling set points
- Adjust the heating and cooling schedule
- View the heating and cooling history
- Control fans

- Terms* The following terms are used in the **Configurator** to describe the equipment in a climate system:
- **Communication Device:** The method the g! software uses to communicate with an external device, including information about the connection type and protocol. In the overview diagram, the communication device uses one of the built-in COM ports on the ELAN controller.
 - **Thermostat:** The physical thermostat which can control heating, cooling, or fans.
 - **Heating/Cooling (HVAC) Unit:** The HVAC equipment as seen by the thermostat. From the g! software's perspective, there are only three aspects of the Heating /Cooling Unit that are important:
 - Heating control
 - Cooling control
 - Fan control

- How-to* To integrate a climate system:
- Add the **Communication Device**
 - Add and configure **Heating/Cooling Units**
 - Discover and configure the **Thermostats**
 - Configure **Schedules** (optional)

Once you add the Communication Device, The g! software will (in most cases) automatically import all the thermostats using the **Discover Devices** feature on the Communication Device's Property window.

Exercise 1: Add a Communication Device

Overview In this exercise, you will add a **Communication Device** to communicate with the thermostats. The **Communication Device** is the bridge between the g! software and the thermostats, and is where you specify how the systems are physically connected and what communication protocol is used.

Note: Actual system setup may be different depending upon which thermostats are installed on site. Refer to the *Integration Notes* for the thermostats you are working with for more detailed information.

How-to 1) Start the **Configurator**, click the **Climate** tab at left, then click **Communication Devices**, as shown below:



- 2) Right-click **Communication Device** and select **Add New Communication Device**. In the dialog box:
- Enter "Climate" as the **Device Name**
 - Communication Type** select **Virtual HVAC Network**
 - Hardware Type** select **Serial Port**
 - Select an **Unassigned COM Port** in the **COM Port** drop down (See Note)
 - Click **OK**.

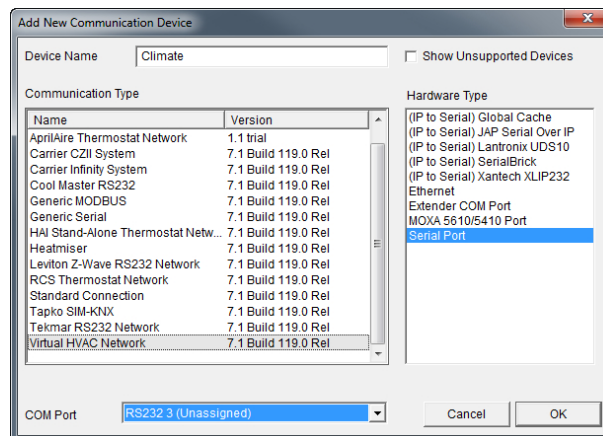

Note: The drop-down menu only shows the ports that are available.

Quick Reference: Add New Communication Device	
Device Name	Enter a name for the external device. This can be any name, but should be descriptive so that you can identify this specific device in the Configurator. DO NOT leave this field set to "New Device".
Show unsupported devices	Select this checkbox to display legacy devices on the Device dropdown list. Legacy devices have not been tested with the current version of g! and are no longer supported by ELAN. If you choose to install an unsupported device, a message will display to warn that the device is not supported by ELAN technical support.
Communication Type	This is the protocol of the communication. See the <i>Integration Note</i> for the specific thermostat for more information.
Hardware Type	The type of connection you are using, such as serial port or Ethernet.
Device	This drop down will populate with the appropriate device for the selected Hardware Type. I.E. When Serial Port Hardware Type is selected the Device dropdown changes to COM Port.

- 3) The **Communication Device** is selected in the system tree as shown below.
- 4) In the Property Pane window at right, verify the **COM Port** selected is correct.

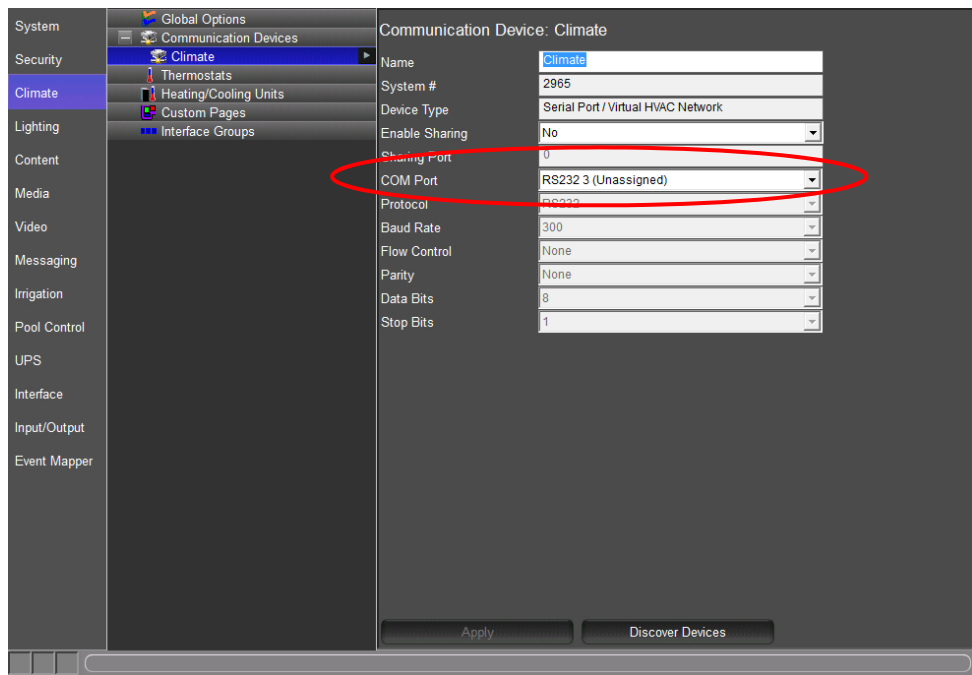

Exercise 2: Add the Heating/Cooling Equipment

Overview After configuring the Communication Device, we will add in the Heating/Cooling Unit(s) prior to adding the Thermostats.

In a typical installation, the specifics of the heating and cooling systems are transparent to the g! software. The software communicates with the thermostat to change modes and set temperatures, and the thermostat itself turns the heating and cooling units on or off, depending on the chosen set points.

While the particulars of the HVAC equipment are not required, the g! software needs to know the types of equipment the thermostat controls so it can display the proper modes in the Viewer and track system usage appropriately in the History tab.

In the steps below, we will add an HVAC Unit and have the opportunity to choose the types of systems it controls: Heating, Cooling, or Fans.

- How-to*
- 1) In the **Configurator**, right-click **Heating/Cooling Units**, then click **Add New Device**.
 - 2) In the **Add New Device** dialog box, select **Generic HVAC Unit** as shown below, and then click **OK**.

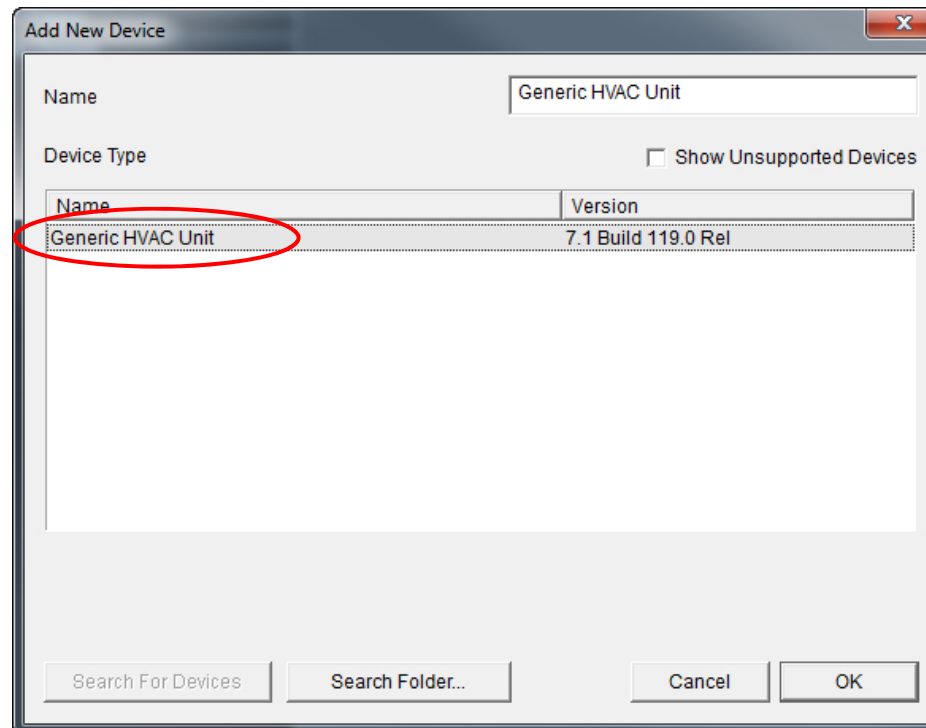

- 3) Select the new Generic HVAC Unit in the system tree as shown below. Note that by default this unit controls Heating, Cooling and Fan(s), so these options are set to **Yes**. This will result in buttons displaying on the **Viewer** to allow the homeowner to set heating and cooling set points, as well as control the fans.

System	Global Options	Device : Generic HVAC Unit
Security	Communication Devices	Name
	Climate	Generic HVAC Unit
	Thermostats	System #
Climate	Heating/Cooling Units	2966
	Generic HVAC Unit	Driver Version
	Custom Pages	7.1 Build 119.0 Rel
Lighting	Interface Groups	Device Type
		Generic HVAC Unit
Content		Controls Heating
		Yes
Media		Controls Cooling
		Yes
Video		Controls Fan
		Yes
Messaging		Heat Cost per Hour
		0.000
		Cool Cost per Hour
		0.000

Note: In an actual system, you will need to set up a Generic HVAC Unit in the Configurator for each physical unit in the home. If you are setting up multiple systems, be sure to assign a unique name to each unit to make it easier to identify if you need to troubleshoot later on.

Exercise 3: Discover and Configure Thermostats

Overview Before beginning this exercise, be sure that you have completed Exercise 2, *Add the Heating/Cooling Equipment*. You will associate the HVAC unit with the system thermostats in this exercise.

In a typical installation, the system can often detect how many thermostats are present and automatically add them to the System Tree. Once the thermostats are recognized by the g! software, you will name each one and assign its **Heating and Cooling Units**.

Note: Actual system setup may be different depending upon which HVAC Unit is installed on site. Refer to the *Integration Notes* for the particular thermostat for details.

How-to

- 1) In the **Configurator**, navigate to the properties window for the Communication Device you set up in Exercise 1.
- 2) Click **Discover Devices** at the bottom of the screen. After a slight pause, the thermostats will be displayed in the System Tree.
- 3) Select the first thermostat, **Thermostat: ID1**, in the System Tree and do the following:
 - a) Change the **Name** to "Living Room."
 - b) Verify the **Heating Unit** and the **Cooling Unit** fields were associated to the **Generic HVAC Unit** you set up in Exercise 2.
 - c) Click **Apply**.

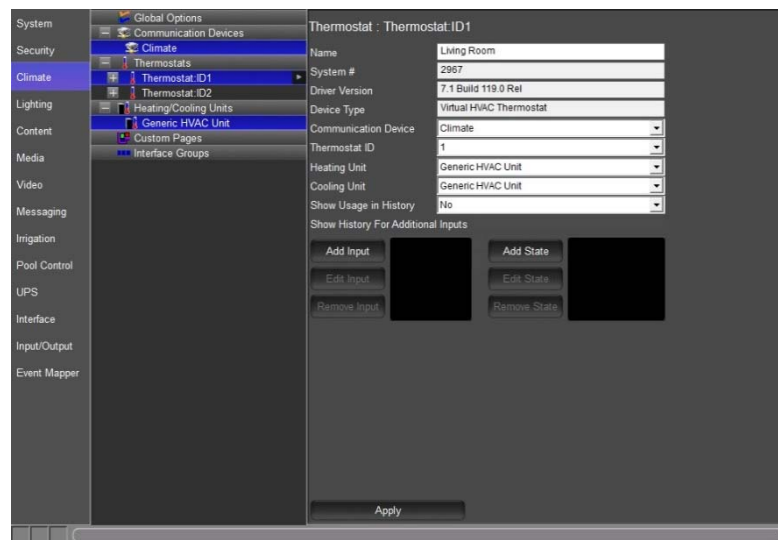

- 4) Select the next thermostat in the System Tree and do the following:
 - a) Change the **Name** to “Bedroom.”
 - b) Verify the **Heating Unit** and the **Cooling Unit** fields were associated to the **Generic HVAC Unit** you set up in Exercise 2.
 - c) Click **Apply**.

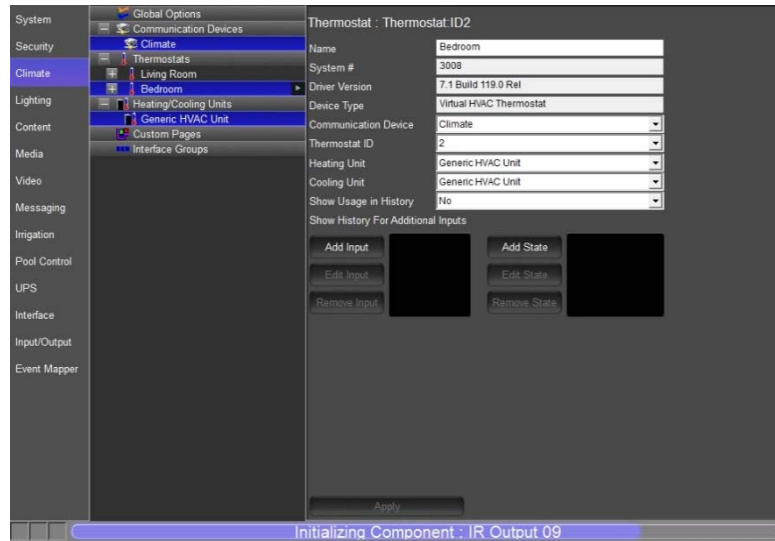

At this point the equipment is added and you can set up **Schedules**.

Climate Scheduling Overview

Overview The g! software can set up different schedules for the home thermostats to turn on heating and/or cooling automatically at different times of the day, according to the homeowner's preferences.

The g! software uses the following concepts for schedule management:

- **Mode.** A unique schedule can be configured for each house mode (Home, Away, etc.) so that when the home owner changes house modes, the climate schedules automatically change too.
- **Weekly Program.** The days of the week that you want this schedule to be in effect for the selected Mode. An example is to set up one schedule for week days and a different schedule for weekends.
- **Period.** A period is a portion of the day for which you want a specific heating/cooling range to be in effect. In the g! software, you can configure up to four periods in a day.

Note: Each thermostat in the Configurator System Tree is tied to its own schedule. Making changes to the schedule on one thermostat does not change the settings on any other thermostat.

Schedules are set up and managed in two steps:

- 1) The **Configurator** is used to perform initial setup to create, name and provide the basic structure for schedules.
- 2) The **Viewer** is then used to change the actual start times and the set points and work with schedules on a regular basis.

*Example
for
Training*

In the following exercises, you will configure the system to:

- Use the two house modes Home and Away.
- Set up different schedules for each thermostat: Living Room and Bedroom.

Home Mode:

- Living Room will have two weekly programs, one for weekdays and one for weekends. Each program will have two periods.
- Bedroom will also have two weekly programs, one for weekdays and one for weekends. Each program will have four periods.

Away Mode:

- Living Room and Bedroom will both have one weekly program with one period per day.

Exercise 4: Set Schedules

Overview In this exercise, you will set up the thermostats so they have weekday and weekend schedules, as in the previous example using two periods per day for the Living Room and four periods per day for the Bedroom. Both the Living Room and Bedroom will be set up so that when the home owner is away there is one set point for the whole week with just one period for the whole day.

- How-to*
- 1) In the Configurator, expand the **Living Room** thermostat and select **Schedule Layout**. *The Schedule Layout properties display on the right.*
 - 2) *In this screen:*
 - a) Change the **Number of Schedules** to 2. *A second line, Schedule 2, displays on the screen.*
 - b) Select **Home** for Schedule 1, and Away for Schedule 2.
 - c) Click **Apply**. *The screen should match the following:*

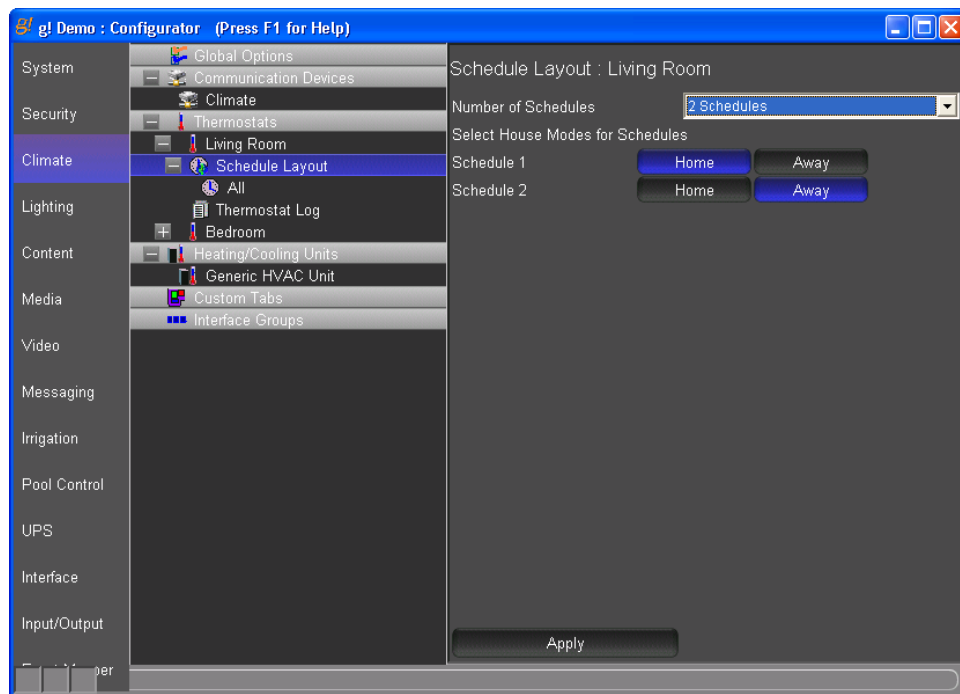

- 3) Click the **Home** schedule in the System Tree at left. *The weekly program for the Home mode displays on the right.*

- 4) Set the Home schedule properties:
 - a) Change the **Periods per Day** to 2
 - b) Set the **Number of Weekly Programs** to 2
 - c) Click on **Program 2** for Saturday and Sunday; click **Program 1** for all other days.
 - d) Click **Apply**. *The screen will look like the one shown below.*

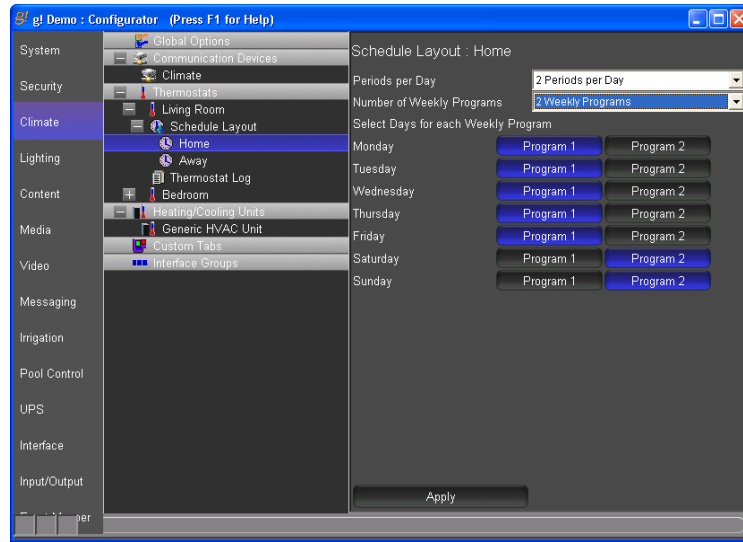

- 5) Select the Living Room **Away** schedule in the System Tree. *The weekly program for the Away mode displays on the right.*
- 6) Set the Away schedule properties:
 - a) Set **Periods per Day** to 1
 - b) Set **Number of Weekly Programs** to 1
 - c) Click **Apply**. *The screen should look similar to the one shown below.*

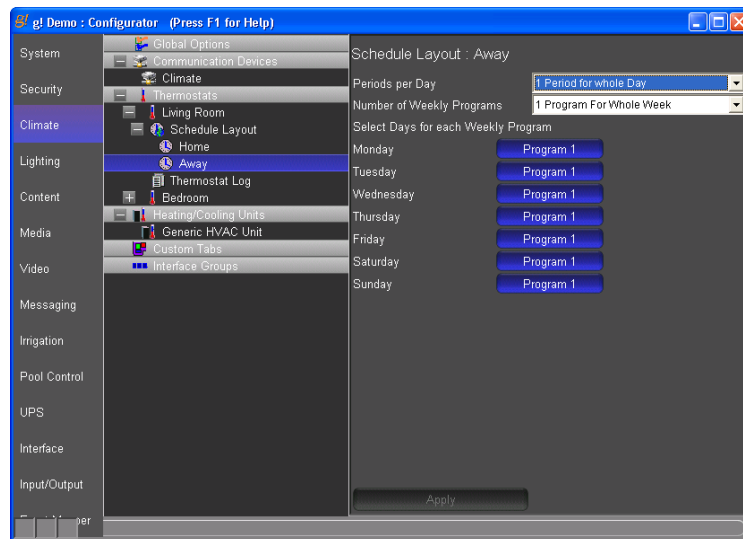

- 7) In the System Tree, select **Schedule Layout** for the **Bedroom** thermostat.
- 8) Set **Number of Schedules** to **2**, schedule 1 is **Home** and schedule 2 is **Away**. Click **Apply** when finished.
- 9) Set up the Bedroom **Home** schedule as follows:
 - a) Set **Periods per Day** to **4**
 - b) Set the **Number of Weekly Programs** to **2**
 - c) Click on **Program 2** for Saturday and Sunday; click **Program 1** for all other days.
 - d) Click **Apply**. *The screen will look like the one shown below.*

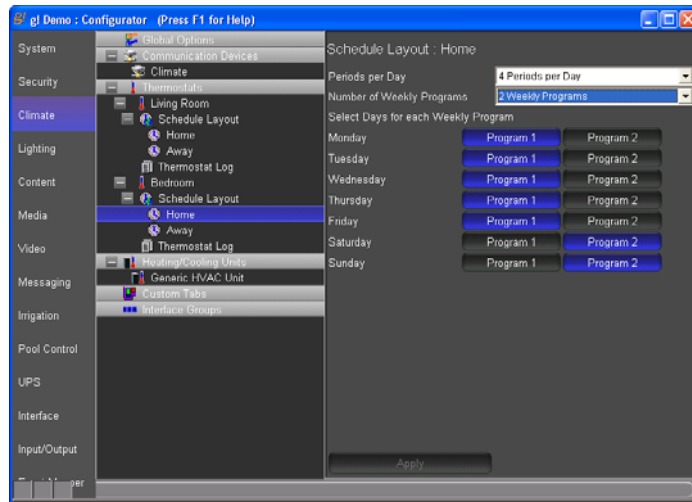

- 10) Select the Bedroom **Away** schedule in the System Tree, and set the properties as follows:
 - a) Set **Periods per Day** to **1**
 - b) Set the **Number of Weekly Programs** to **1**.
 - c) Click **Apply**.

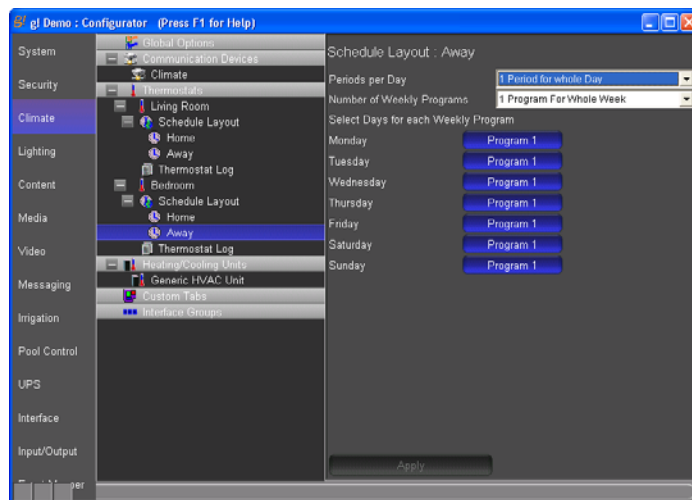

Exercise 5: Check the Viewer

Overview In exercises 1-4, you used the Configurator to set up the Climate app. In exercises 5 and 6, you will check your configuration in the Viewer and use the Viewer to set the heating and cooling set points for each period in each thermostat's schedule.

- How-to*
- 1) From the g!Tools My Systems screen, click the **Viewer** button. The Viewer interface displays the **Main Menu** page.
 - 2) Select the **Climate** icon to show the available climate zones. Select the **Living Room** zone.

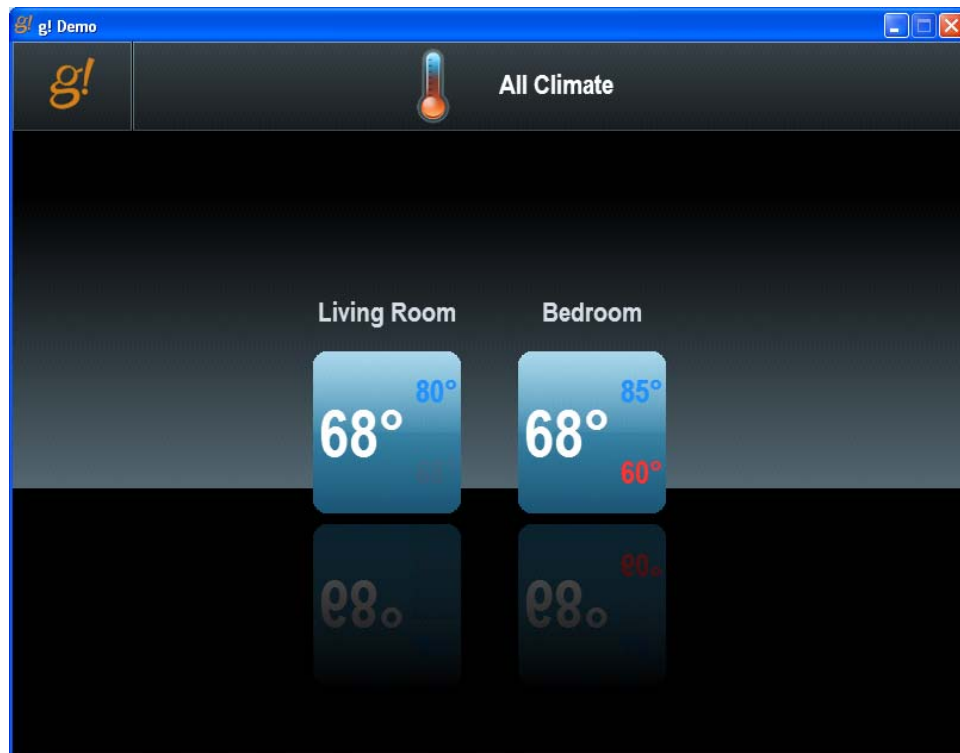



On this screen notice:

- The Heating set point and adjustment buttons are shown in the lower right part of the screen in red
- The Cooling set point and adjustment buttons are shown in the upper right part of the screen in blue
- The current Room Temperature is shown left of center in white
- The thermostat and fan are running in Auto Mode
- The Fan and Mode options are dependent on the thermostat being used. Always refer to the g! Integration notes for information on compatible devices and their supported features.
- The Fan button sets the fan mode on the thermostat. Common modes include:
 - Fan Auto Mode, the fan runs only when the system is adjusting the room temperature to a desired set point.
 - Fan On Mode, the fan runs continuously.
- The Mode button is used to set the mode on the thermostat. Common modes include:
 - Off Mode, the heating and cooling systems are both off and only the room temperature is shown.
 - Cool Mode, only the cooling set point and adjustment buttons are shown to maintain the desired cooling setting.
 - Heat Mode, only the heating set point and adjustment buttons are shown to maintain the desired heating setting.
 - Auto Mode, both cooling and heating set points and adjustment buttons are shown and the thermostat switches between heat and cool to maintain the desired temperature setting. Please refer to the thermostat manual for details on compatibility with Auto Mode.
- Access is provided at the top to view the Schedules and History

- 3) Click the Up arrow next to the Heating Set Point to change the setting to 70 degrees.



- a) After a short pause the heat Set Point begins to blink indicating that it is actively heating.
- 4) Click the arrow next to the Mode: button to display the selection list. Select the **Heat** mode from the list.



- a) The modes shown populate with the available modes from the compatible thermostat being used, options shown will vary. Please refer to the compatible devices' Integration Notes for more information and supported features.

Exercise 6: Check the Schedule tabs in the Viewer

Overview In this exercise you will check the Living Room and Bedroom schedules that configured in the previous exercises and adjust the period start times and set points.

How-to 1) Click the **Schedule** button at the top right of the screen. This brings up the schedule controls where the homeowner can adjust times and temperature for the thermostat schedule.



a) The button on the bottom left displays the current program status. Click the arrow to the right of the button to select from the list: Run Program, Permanent Hold, Timed Hold, or Temporary Hold.

- 2) Click the **Home Schedule** tab then click **Mon, Tue, Wed, Thu** or **Fri** tab at the bottom to bring up the Home Schedule for the Living Room weekday settings as shown below.



Notice that for each period, Day and Night you can adjust:

- Start Time
- Cool Set Point
- Heat Set Point
- Fan State

- 3) Use the arrows to change the settings to those below. Use the mouse to click the arrow; click and hold to quickly scroll through the times.
 - a) **Day** starts at **7:30am**
 - b) **Night** starts at **10:00pm**.
 - c) **Day Cool** setting is **74**.
 - d) **Fan** is **ON** (will run all day).

These are settings for Monday - Friday. *Your screen should look like the one shown below.*



- 4) Click the **Sat** or **Sun** button to display the weekend schedule. Change the settings so that:
 - a) **Day** starts at **8:00 AM**
 - b) **Night** starts at **11:00 PM**.



- 5) Click the **Away Schedule** tab to display the **Living Room** schedule for when the house mode is set to Away.
- 6) Note that there is just one Heating set point and one Cooling set point, and that all the days are the same. Click the arrows to set the **Heating** to **55** and the **Cooling** to **90**. Your screen should look like the one shown below.

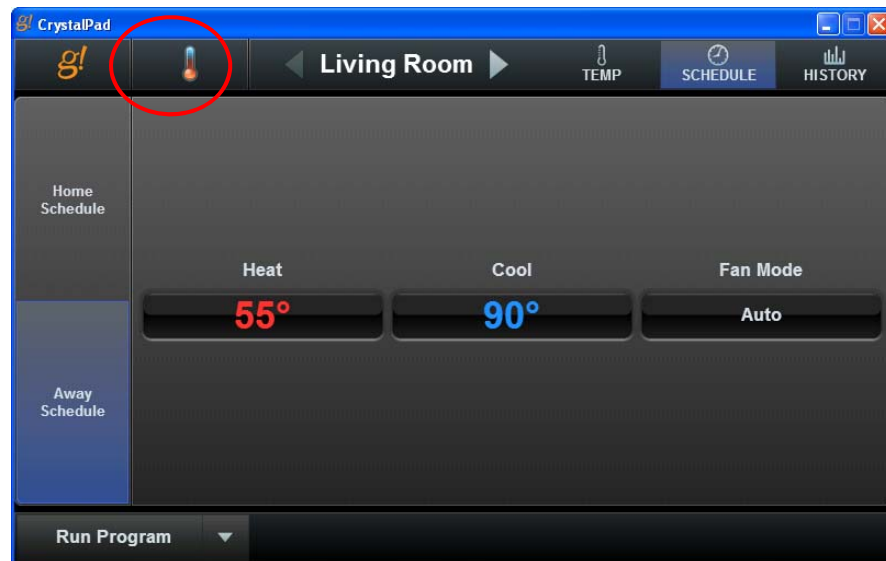

- 7) Click the Thermostat icon at the top of the screen (circled above) to view all climate zones, and then select the Bedroom icon to switch to the **Bedroom** thermostat.

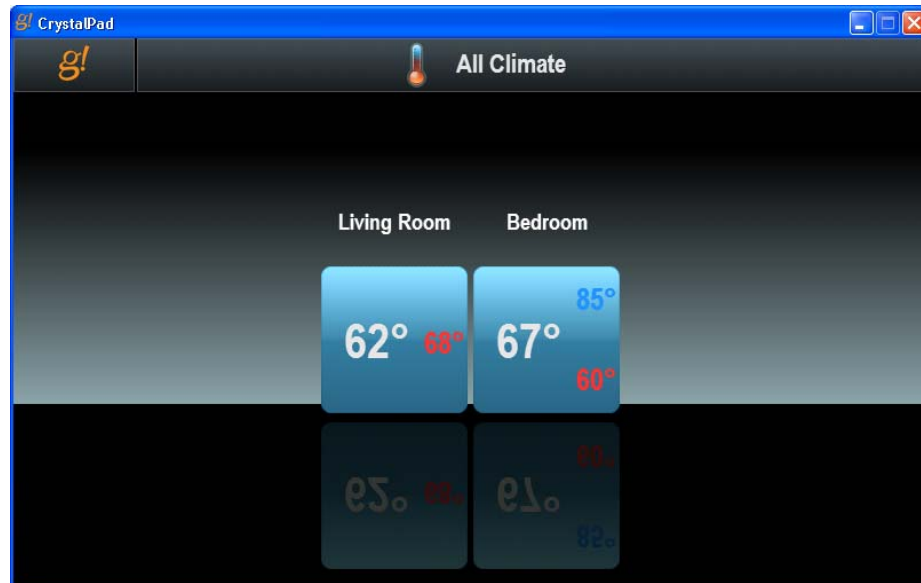

- 8) Click the **Schedule** button and select the Home schedule. Note that here there are four periods per day, with **Monday-Friday** the same, and then **Saturday** and **Sunday** the same.

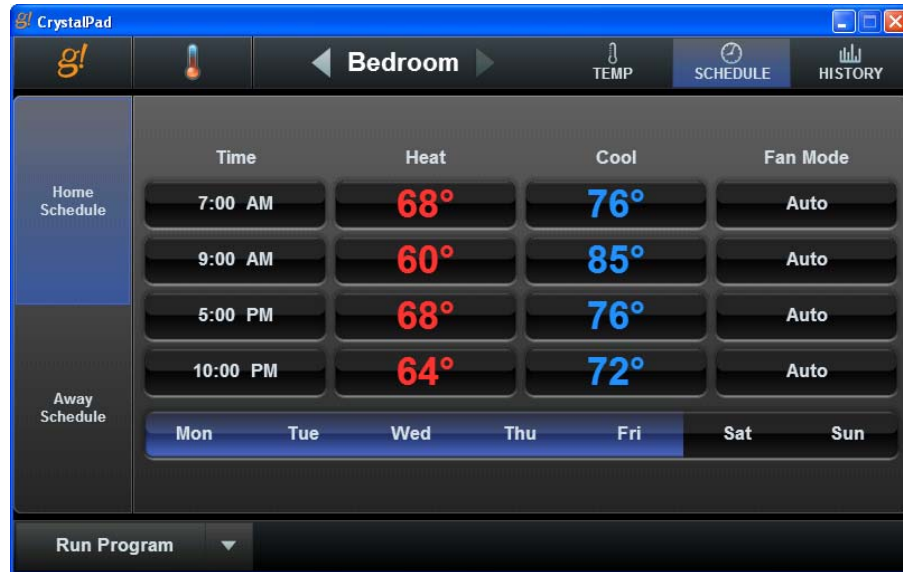

Note: For more information about working with system modes, please refer to the *Common Applications Guide*.

Exercise 7: Check the History in the Viewer

Overview The **History** in the **Viewer** tracks historical information so that homeowner can see what has been happening with their system. Because the HVAC system has not been running for long, your history will be minimal.

Example Screen



Lesson 5

Configuring Lighting Systems



Overview

This lesson shows you how to configure a lighting system.

You will:

- Learn how lighting systems are organized in the Configurator.
- Use the Configurator to setup the Communication and Lighting Interfaces that represent the basic lighting hardware.
- Learn how to create a custom keypad for the Viewer interface and add scenes.
- Learn how to create a custom interface layout for the Viewer interface.

Sample House

Our Sample House and attached garage will be configured with ten lighting loads and one physical keypad. The loads will be distributed as follows:

- Main House- Four dimmers and a physical keypad
- Theater- Three Dimmers
- Garage and Outside- Three Dimmers

Requirements

- A PC running g!Demo and g!Tools.

-OR-

- g! system controller and g!Tools.

Lighting Integration Overview

Overview The following diagram shows the equipment in a typical lighting system schematically, illustrating the components that are important to the g! system controller. The lines drawn between the lighting controller and the dimmers, switch and keypad represent the communication link between the controller and these devices. These links can be created using low-voltage cables, RF signals or the power lines themselves, depending upon the lighting system.

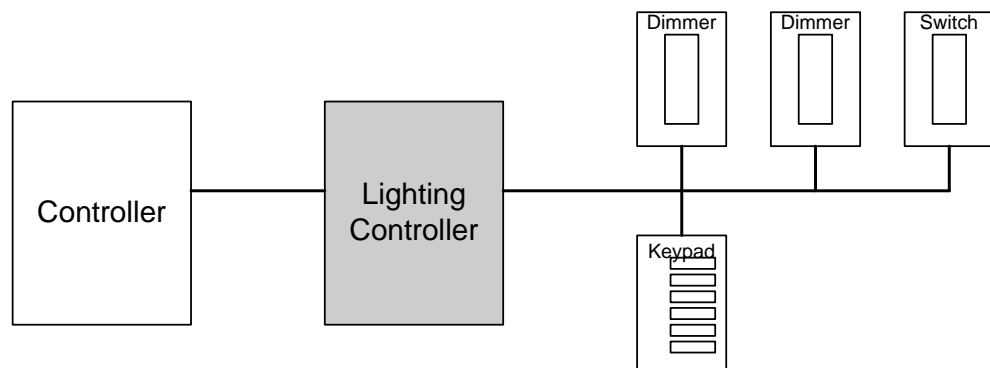

Integrating a lighting system with the g! software will provide the homeowner access to their system through the Viewer. This will enable them to:

- Turn loads on and off
- Set the brightness of loads controlled by dimmers
- Actuate pre-programmed scenes
- Set up a lighting schedule
- View status of the loads in the lighting system

- Terms* The following terms are used in the Configurator to describe the equipment in a lighting system:
- **Communication Device:** The method the g! software uses to communicate with an external device, including information about the connection type and protocol. In the overview diagram, the communication device uses one of the built-in COM ports on the ELAN controller.
 - **Lighting Interface:** The lighting controller or interface module.
 - **Switch / Dimmer:** The device that switches the load (turns lights on, off, or dim/brighten).
 - **Keypad:** Typically a wall-mounted controller with several **Scene** buttons. In some cases, a keypad can also switch a load.
 - **Virtual Keypad:** A software representation of the wall-mounted keypad that can also be used to control lighting loads.
 - **Custom Keypad:** A software keypad that is configured to provide a more personalized experience for the user such as access to user-preferred controls, or preferred buttons, etc.
 - **Custom Tab.** A custom interface page that can optionally be added to the lighting Viewer interface. The custom interface can be configured with any of the available controls.
 - **Scene.** A group of switches and dimmers that turn on to a specific level or turn off from a single command.

How-To To integrate a lighting system with g!:

- Add the **Communication Device**.
- Add the **Lighting Interface**
- **Discover Devices** to add the **lighting loads** and **keypads**.
- Organize the **Viewer** interface with the desired **keypads, custom interfaces, and custom controls**.

Once the lighting interface has been added, the g! software is able (in most cases) to automatically import all of the lighting loads and keypads. This is accomplished by using the **Discover Devices** or **Read Config File** feature in the lighting interface.

Exercise 1: Add Communication Device

Overview In this exercise, you will add a Communication Device to communicate with the lighting system. The communication device is the bridge between the g! software and the light switches, and is where you specify how the system is physically connected and what communication protocol should be used.

Note: Actual system setup may be different depending upon which lighting system is installed on site. Refer to the *Integration Notes* for the particular lighting systems for details.

How-To

1. Start the Configurator, click the **Lighting** tab at left, then click **Communication Devices**, as shown below:

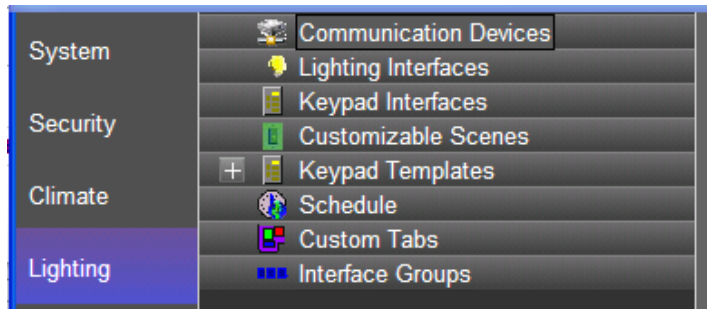

2. Right-click **Communication Device** and select **Add New Communication Device**. In the dialog box:
 - a. Enter "Lighting" as the **Device Name**
 - b. **Communication Type** select **Standard Connection**
 - c. **Hardware Type** select **Serial Port**
 - d. Select an **Unassigned** COM Port in the **COM Port** drop down (See Note)
 - e. Click **OK**

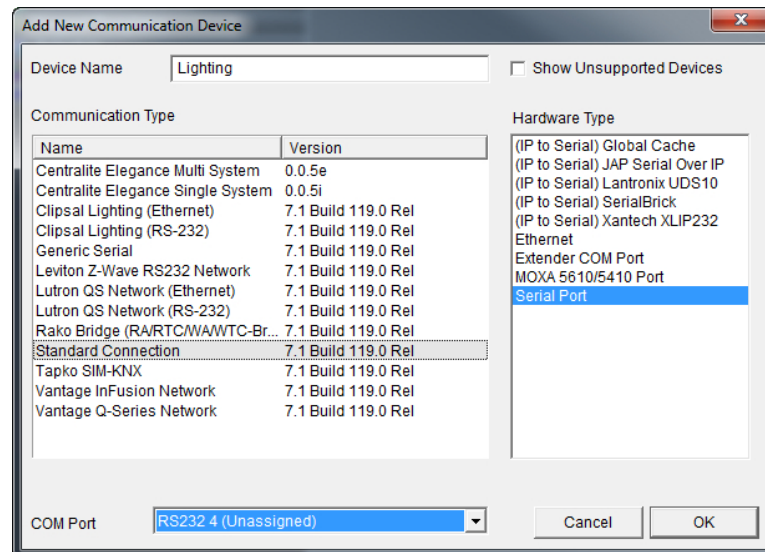

Note: The drop-down menu only shows the ports that are available. If you are running **g!Demo** on your laptop you will only see available ports on the laptop. Leave the selection set to **NONE** if you are using **g!Demo**.

Quick Reference: Add New Communication Device	
Device Name	Enter a name for the external device. This can be any name, but should be descriptive so that you can identify this specific device in the Configurator. DO NOT leave this field set to "New Device".
Show unsupported devices	Select this checkbox to display legacy devices on the Device dropdown list. Legacy devices have not been tested with the current version of g! and are no longer supported by ELAN. If you choose to install an unsupported device, a message will display to warn that the device is not supported by ELAN technical support.
Communication Type	This is the protocol of the communication. See the <i>Integration Note</i> for the specific thermostat for more information.
Hardware Type	The type of connection you are using, such as serial port or Ethernet.
Device	This drop down will populate with the appropriate device for the selected Hardware Type. I.E. When Serial Port Hardware Type is selected the Device dropdown changes to COM Port.

3. The **Communication Device** is selected in the system tree as shown.
4. In the Property Pane window at right, verify the **COM Port** selected is correct.

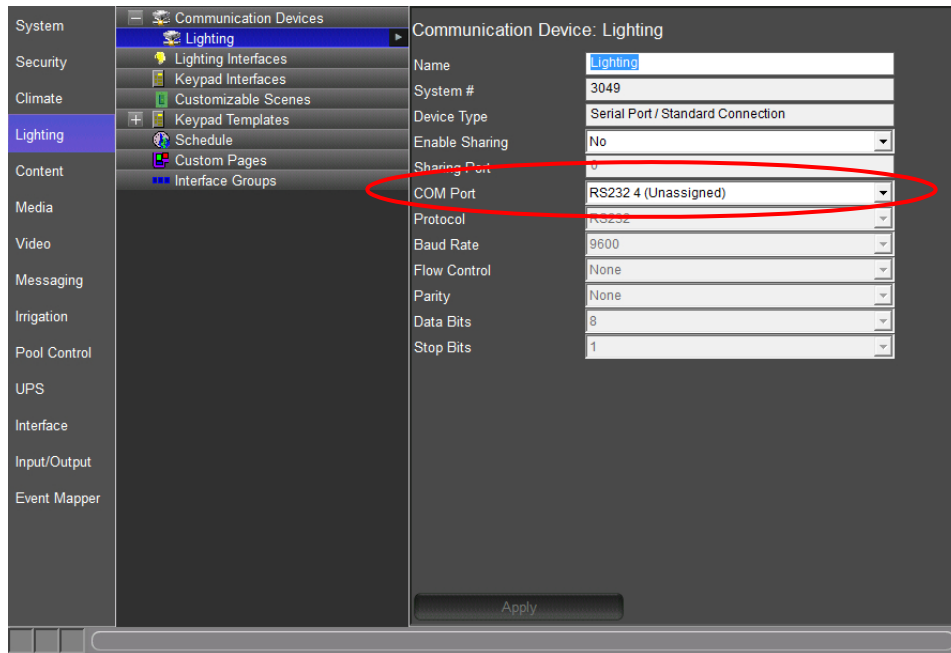

Exercise 2: Add the Lighting System and Discover Devices

Overview Before beginning this exercise, be sure that you have completed Exercise 1, *Add the Communication Device*. You will need to associate the communication device with the lighting device in this exercise. For most lighting systems, the names of the devices will be populated automatically.

Note: Actual system setup may be different depending upon which lighting system is installed on site. Refer to the *Integration Notes* for the particular lighting system for more details.

- How-To*
1. On the Lighting tab, right-click Lighting Interfaces and select Add New Lighting Interface.
 2. Select Virtual Lighting Device Controller, and then click OK

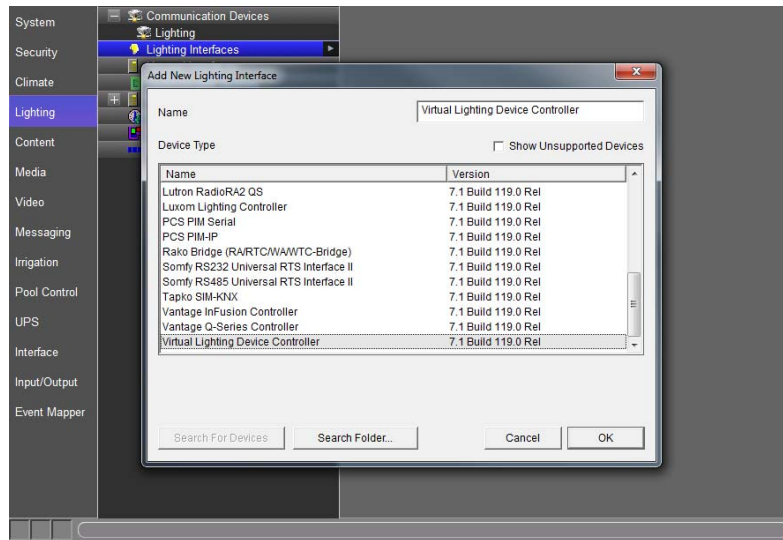

3. Verify that the **Communication Device** is set to **Lighting**.

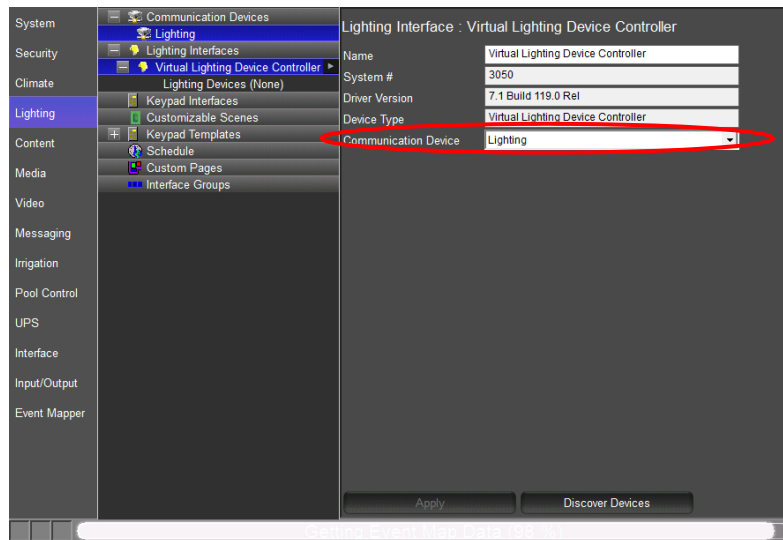

- Click **Discover Devices** at the bottom of the screen.
After a slight pause, the lighting loads and keypads will be displayed in the System Tree.
Once the Discover Devices process is complete, there will be ten dimmers and one keypad in the configuration.

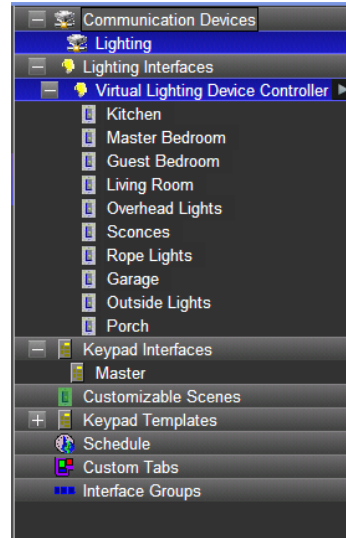

Check the Viewer Interface

When you have finished the configuration, check your work in the Viewer.

- From the g!Tools My Systems screen, click the **Viewer** button. The Viewer interface displays the **Main Menu** page.
- Select the **Lighting** icon to show the “Master” keypad listed in the Configurator.

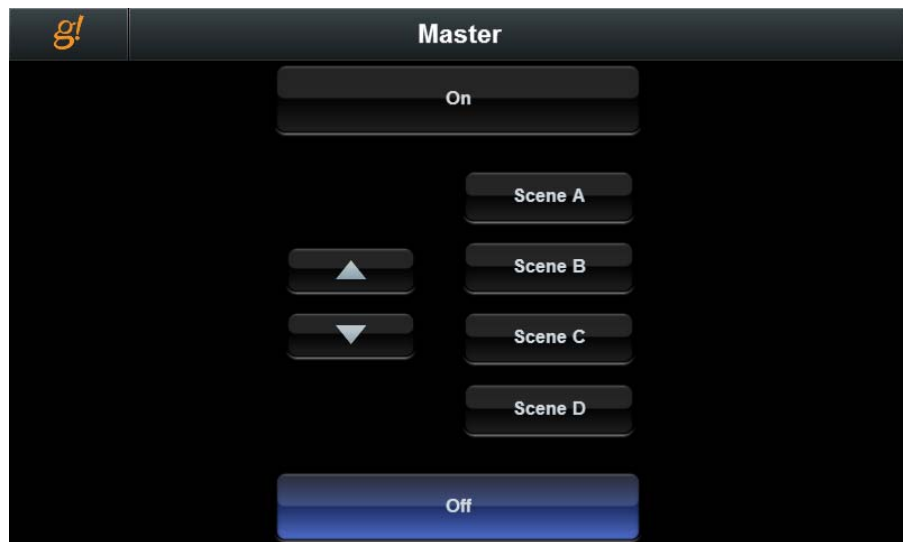

Note: The Configurator adds Viewer interface pages for each keypad by default. Note that individual loads (switches and dimmers) don't automatically display in the interface. The names of the buttons that display in the virtual keypad can be edited. See Exercise 3, *Create a Custom Keypad* for more information on editing the button text.

Exercise 3: Create a Custom Keypad

Overview Before beginning this exercise, be sure that you have completed Exercise 2, *Add the Lighting System and Discover Devices*.

In this exercise, we will create the graphic layout for a simple three-button keypad to control lighting scenes in the theater.

How-To

1. In the Configurator **Lighting** tab, right-click **Keypad Interfaces** in the System Tree.
2. Click **Add New Keypad**. *The Add New Lighting Keypad window displays.*
 - a. Type “Theater” in the **Keypad Name** box.
 - b. Select **Virtual Keypad** from the **Interface Device** drop-down list.
 - c. Select **Empty Virtual Keypad** as the **Keypad Type**.



- d. Click **OK**. *An empty custom keypad bezel displays in the properties window. This keypad is now part of the system and can be seen in the Viewer.*
3. In the properties window, click on the new keypad bezel once to select it — notice that the keypad is outlined in yellow. Click the blank keypad again and notice that the yellow outline turns to red. A red outline indicates that the keypad can be moved or resized.

4. Move the mouse over the red line on the left side of the keypad. The cursor turns into a double-headed arrow to indicate that you can click and drag to resize the selected object. Click and hold your left mouse button, then move your mouse to the right to enlarge the blank keypad bezel until it occupies about half of the black background:

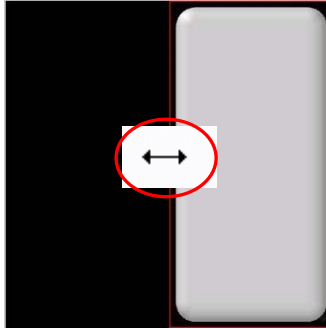

5. Right-click inside the empty keypad at (or near) the spot where you want to add a button and select **Add New Control** from the pop up menu. *A new control appears on the keypad.*



6. Click the New Control to select it. *The Lighting Keypad Button properties window displays.*
7. Type **House Lights** in the **Text** field.

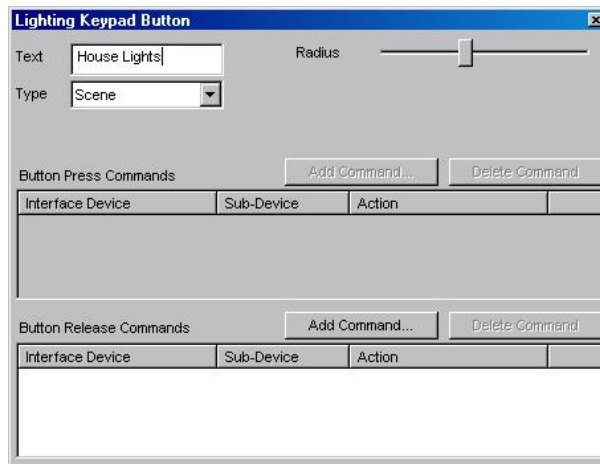

8. Repeat steps 3 and 4, adding two more buttons for a total of three. Name these buttons **Show Movie** and **All Off**.

9. Resize the House Lights button.

- a. Click the House Lights button. *It will be surrounded by a yellow line, indicating that it is the selected object.*
- b. Move the mouse over the yellow line on the left or right hand side.

The cursor will become a double headed arrow. ↔

- c. Click and hold the mouse button. *The yellow line will turn red, indicating that the button can be resized.*
- d. Stretch the button horizontally until you can read all of the words "House Lights".

10. Center the House Lights button in the keypad.

- a. Place the cursor to the center of the button.

The double headed arrow will become a four way arrow. ↕

- b. Click and drag the button so that it is centered left and right, and in the top third of the keypad.

11. Align the buttons on the keypad.

- a. Click the **All Off** button to select it, then hold the CTRL keyboard key and click the **Show Movie** and **House Lights** buttons to select them. *Individual selected button will be highlighted in yellow, and all three will be surrounded by a green box.*
- b. Right-click the **All Off** button and select **Align Left Edges**. *All of the buttons will line up with the left side edge of the House Lights button. Since the House Lights button was the last one selected in the group it will be the master that the other controls will reference in the following steps .*
- c. Right-click the **All Off** button and select **Make Same Width**. *All of the buttons will become the same width as the House Lights button.*
- d. Right-click the All Off button and select **Make Same Height**. *All of the buttons will become the same height as the House Lights button.*
- e. Right-click the All Off button and select **Space Evenly (Y)**. *This will space the buttons evenly on the Y-axis (vertically).*



Your keypad should now look similar to this:



- A few notes about working with the keypad control:**
- The last keypad control selected is the “master” for right-click options such as resizing and centering.
 - The keypad itself is resizable.
 - To move a control, click and drag it to its new location.
 - To resize a control, click the red border and drag it in the desired direction.
 - Use the radius slide control to make the control more or less round.
 - Selected item(s) can be moved “bumped” a pixel at a time using the keyboard arrows.

Lighting Keypad Button Properties Reference	
Text	The word(s) that will appear on the button in the user interface.
Type	Selects the button action. Choices are: Toggle- Changes the load or scene from one state to another (on/off) Momentary- Typically used for dimming, this allows configuration of a lighting action based on press and release, such as begin/end dim. Scene- Activates a group of lighting devices to a pre-configured level. In contrast to the toggle button, pressing a scene button a second time reissues the same scene command.
Radius	Click and drag the slide control to the right to make the corners of the button rounder; to the left to make them squarer.
Button Press Commands	Action to be executed upon button press. Only applies to Momentary button type.
Button Release Commands	Action to be executed upon button release.

Exercise 4: Add Scenes to Keypad Buttons

Overview Before beginning this exercise, be sure that you have completed Exercise 2, *Add the Lighting System and Discover Devices* and Exercise 3, *Add a Custom Keypad*. You will need to associate the lighting loads added in Exercise 2 with the keypad buttons added in Exercise 3.

In this exercise, you will assign lighting loads to turn on at specified levels when buttons on the Custom Keypad are pressed.

- How-To*
1. In the Configurator, Lighting tab, under **Keypad Interfaces**, select the **Theater** keypad interface.
 2. Click the **House Lights** button on the keypad. *The Lighting Keypad Button window opens.*

The screenshot shows the 'Lighting Keypad Button' configuration window. The 'Text' field contains 'House Lights' and the 'Type' dropdown is set to 'Scene'. The 'Radius' slider is positioned at approximately 50%. Below the 'Text' and 'Type' fields are two sections for commands: 'Button Press Commands' and 'Button Release Commands'. Each section has 'Add Command...' and 'Delete Command' buttons. Below each section is a table with columns 'Interface Device', 'Sub-Device', and 'Action'. The 'Button Press Commands' table is currently empty.

3. Create a scene for the **House Lights** button.
 - a. Verify the **Type** is set to **Scene**.
 - b. Click the **Add Command...** button in the **Button Release Commands** section. *The Add Component Lighting Scene window opens.*
 - c. From the **Lighting Device** column, select **Overhead Lights**, then from the **Action** column, select **Set Level to 100%** and click **OK**.

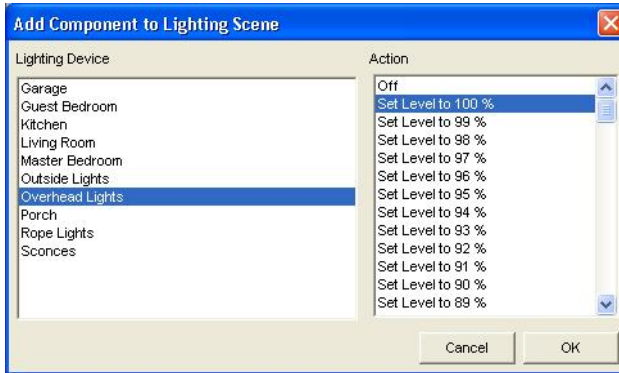

- d. Click the **Add Command...** again. Select **Sconces** in the Lighting Devices column and set the sconce level to 100%. Do the same for **Rope Lights**.
 - e. Close the Lighting Keypad Button properties window.

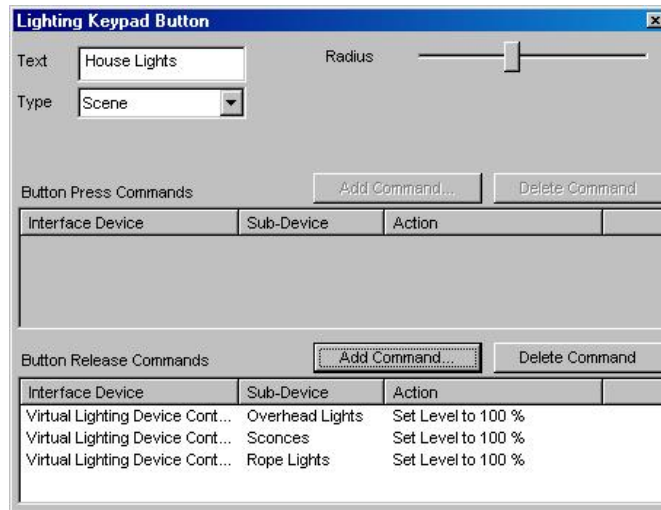

4. Select the **Show Movie** button, and create a scene for this button as follows:
 - a. Set the Overhead and Sconces to “Off”
 - b. Set the Rope Lights to 30%.
 - c. Close the Lighting Keypad Button properties window.
5. Select the **All Off** button. For this scene, set all three loads to “Off”. Close the Lighting Keypad Button properties window.

Exercise 5: Create a Custom Interface

Overview Before beginning this exercise, be sure that you have completed Exercise 2, *Add the Lighting System and Discover Devices*, Exercise 3, *Add a Custom Keypad*, and Exercise 4, *Add Scenes to Keypad Buttons*.

In this exercise, you will create a custom user interface that includes a keypad and some individual lighting controls.

When creating custom User interfaces for a homeowner, it is important to note that you need to create a separate layout for each interface that the homeowner will be using to access their system, such as an in-wall touch screen and an iPhone.

How-To

1. From the Configurator, Lighting tab, right-click **Custom Pages** in the System Tree, then select **Add New Custom Page**.
2. Type "Custom Tab" in the **Name** field.
3. Click the + sign next to **Custom Tab**, select **Large Format**, then select Large Landscape(Wide) from the properties pane on the right.

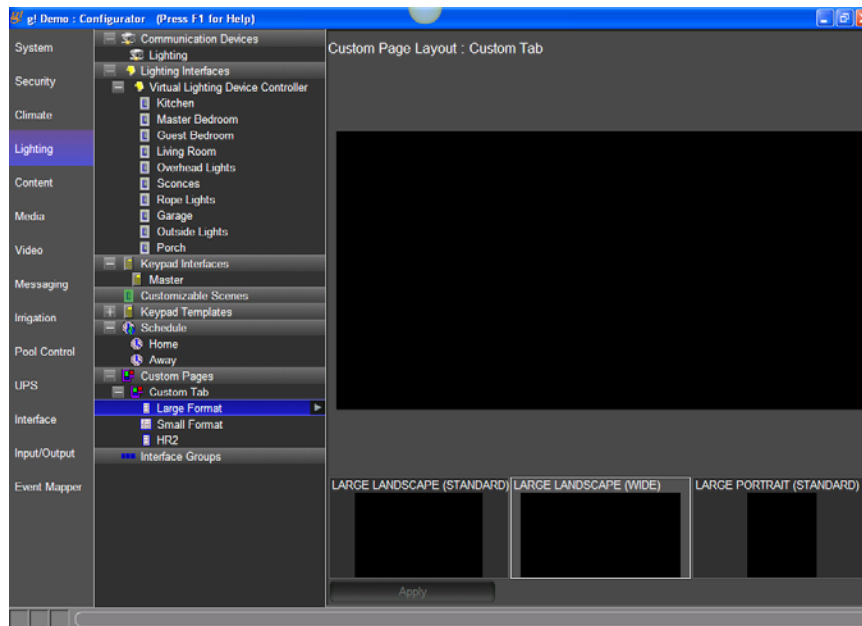
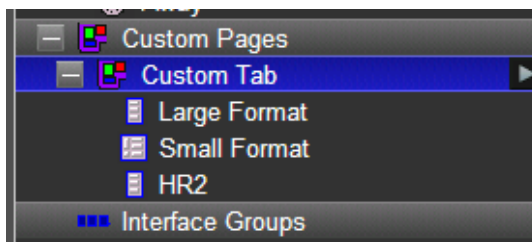

4. Add the Custom Keypad created in previous exercises to the custom tab.
 - a. In the blank area in the properties window, right-click and select **Add New Control**. *The Add New Control window opens.*
 - b. Select **Lighting Keypad** from the **Control Type** list, and then click **OK**. *A preview box labeled Lighting Keypad will appear on the page.*

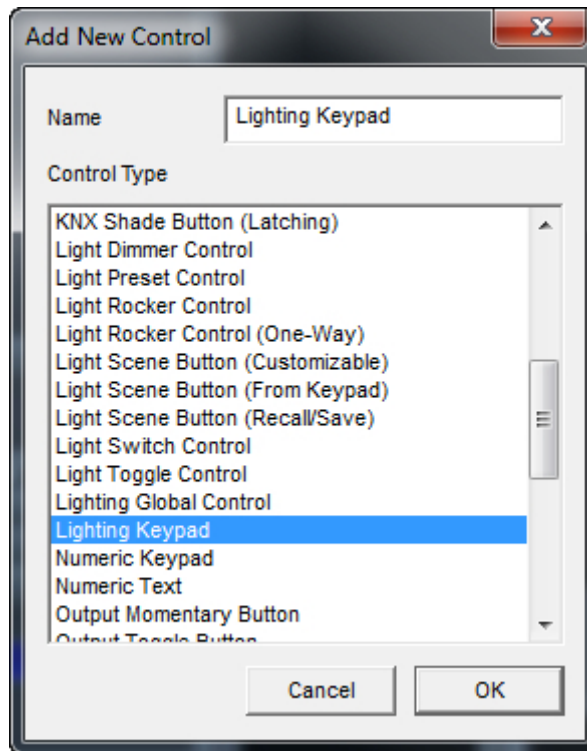

- c. Select the box to display the **Lighting Keypad Properties** window.
- d. Select **Theater** from the **Connect To** drop-down list. *This associates the Theater keypad you created in Exercise 3 with the keypad control on the custom page.*

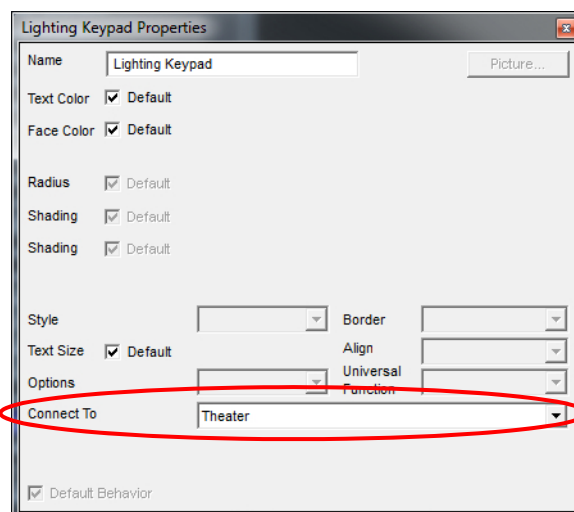

- e. Close the **Lighting Keypad Properties** window, and click **Apply**.
- f. Click the small control again and resize it so that it fills most of the height of the screen. Move it to the left side as shown.

Note: See Exercise 3, *Add a Custom Keypad* for instructions on resizing and moving custom controls.

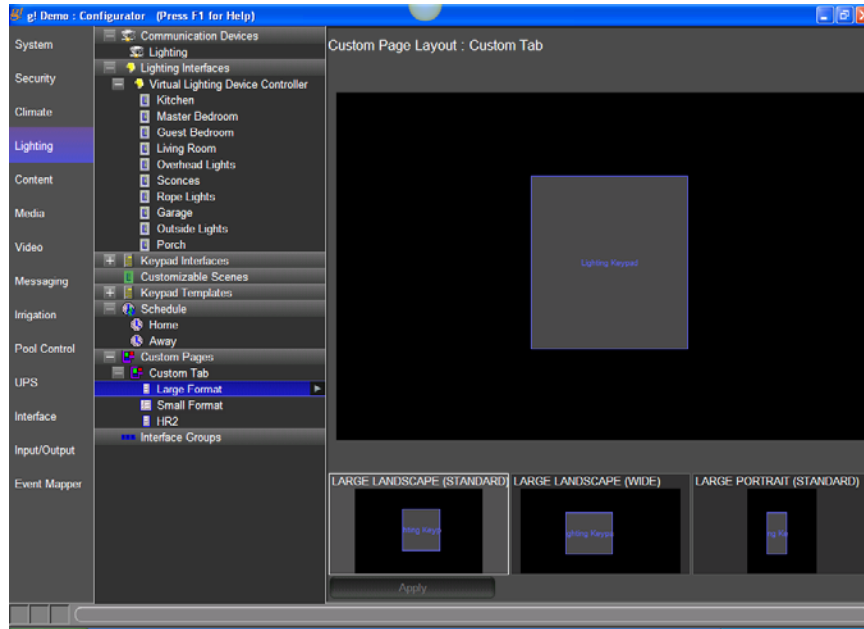

- 5. Add buttons for the Garage, Porch, and Outside Lights to the interface to turn these lights on and off.
 - a. Right-click in the open area to the right of the keypad control you just created, and select **Add New Control**.
 - b. Select **Light Toggle Control**, and then click **OK**.

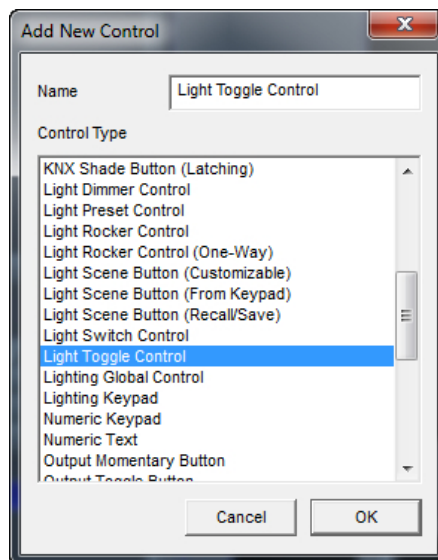

- c. Select the Light Toggle Control and when it is highlighted in yellow, do the following:
- Move the control to the right of the Keypad, and move it up to align with the top of the keypad.
 - Name the control “Garage Lights”.
 - Select **Garage** in the **Connect To** drop-down list.

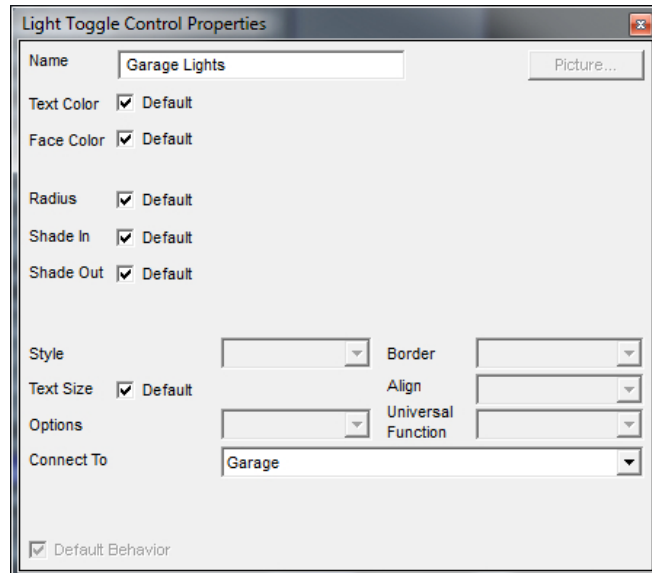

- d. Add two more Light Toggle Controls underneath the Garage Lights button — one for Porch Lights and one for Outside Lights. Connect each to the appropriate load.
- e. Right-click to align the left edge of the buttons and space them evenly on the Y-axis. *At this point, the Custom interface should look something like the example below.*

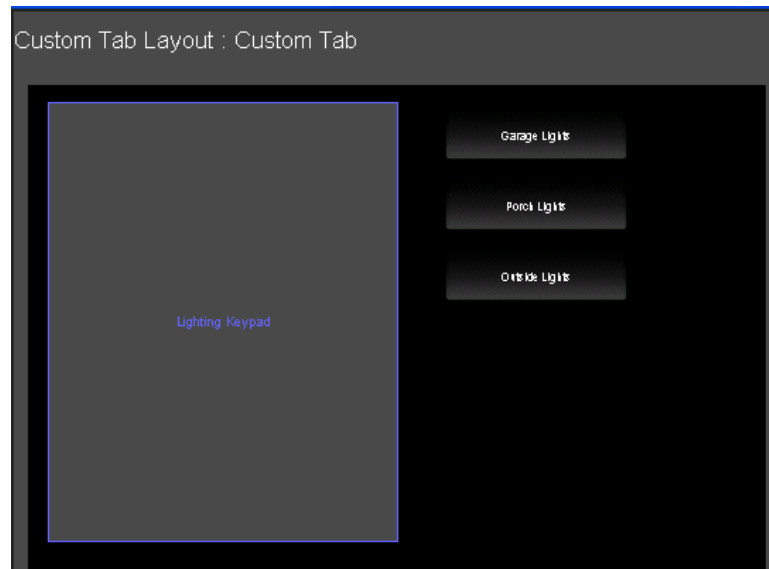

6. Add three Light Dimmer Controls to the Custom interface to control the rope lights, sconces and overhead lights.
 - a. Right-click the open area below the toggle controls and select **Add New Control**. *The Add New Control window opens.*
 - b. Select **Light Dimmer Control** from the list, and then click **OK**.

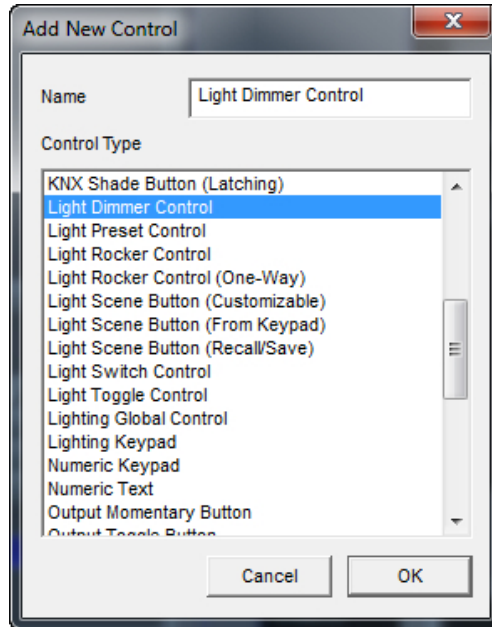

- c. Select the Light Dimmer Control highlighted in yellow, and in the Light Dimmer Properties window:
 - Name the control "Rope Lights"
 - Select **HZ/Bulbs** from the **Style** drop-down list.
 - Select **Rope Lights** from the **Connect To** drop-down list.

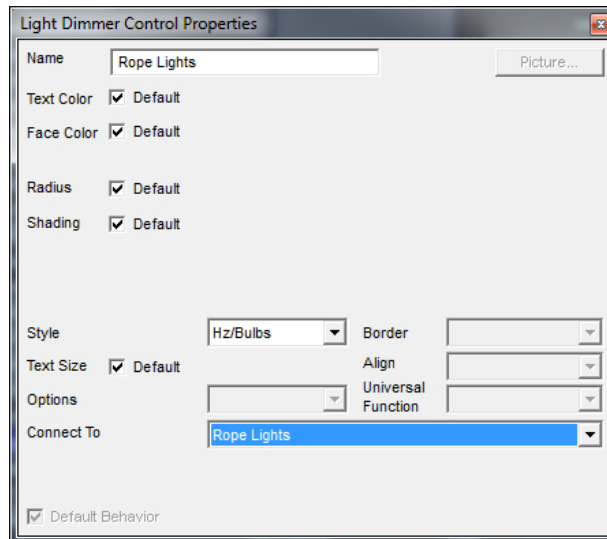

- d. Add two additional dimmer controls below the Rope Lights dimmer — one connected to the **Sconces**, and the other connected to the **Overhead Lights**.
- e. Use the right-click menu to resize and align the three dimmer controls along the left edge and space them evenly on the Y-axis. At this point, the Custom interface should look something like the following example.

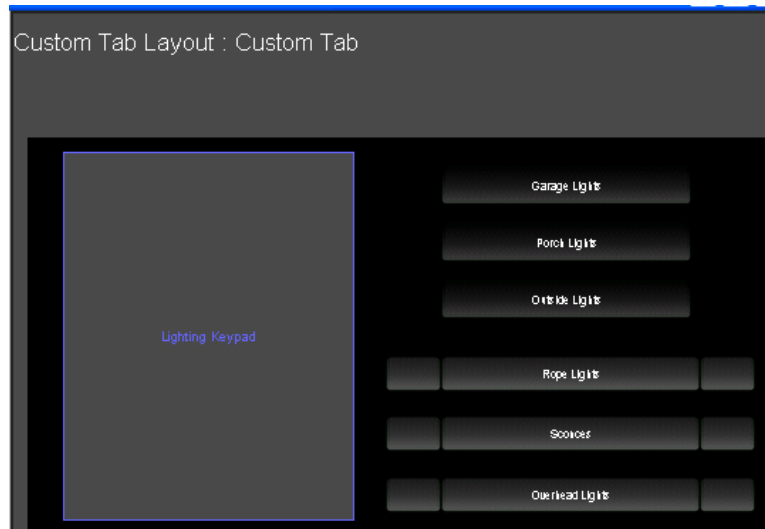

Check the Viewer Interface

When you've finished creating the custom interface, check your work in the Viewer.

1. Start the Viewer, from the homepage click the g! icon to access the main menu then click the lighting icon to access the available lighting interfaces. There should be 3 interfaces shown.



2. Click the **Theater** icon. You should see the three button keypad in the center.

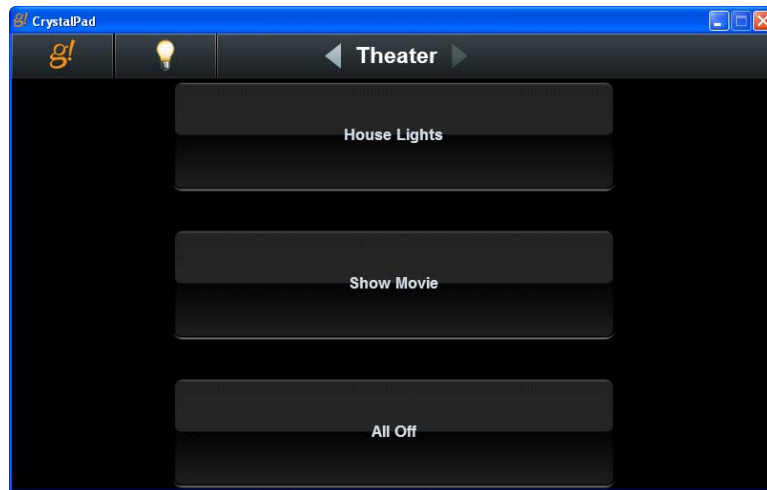

3. Click the light bulb to return to the available lighting interfaces then click the **Custom Tab**. You should see the Theater Keypad on the left, the toggle controls on the upper right, and the dimmer controls on the lower right. Click the buttons on the Theater Keypad and verify that the controls associated with each button move to their intended position.

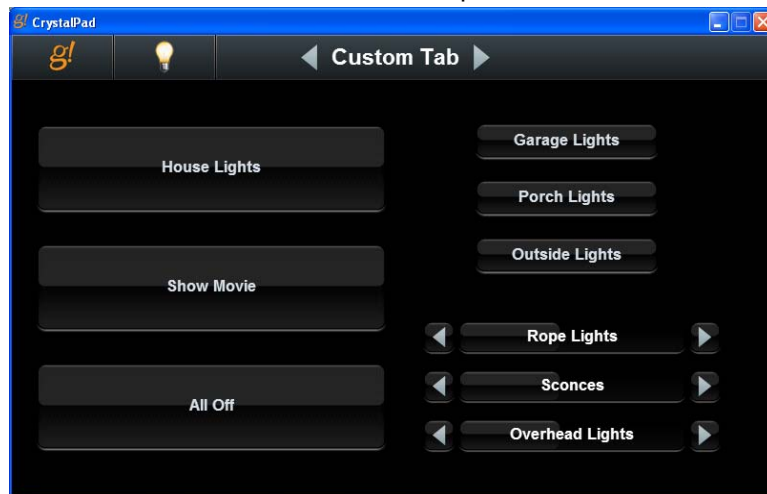

Exercise 6: Copy the Custom Tab to a Different Resolution

Overview Before beginning this exercise, be sure that you have completed Exercise 5, *Create a Custom Tab*. In this exercise, you will copy that interface to a new resolution for use on a different type of interface device, an iPhone for example.

When creating custom user interfaces for a homeowner, it is important to note that you need to create a layout for each interface that the homeowner will be using to access their system, such as an in-wall touch screen and an iPhone.

How-To

1. From the Configurator, Lighting tab, select the Custom Tab created in the previous exercise. Expand the resolution options for this tab if not already expanded.
2. Click the **Small Format** (iPhone/iPod Touch Layout) and select **Copy Layout from LARGE FORMAT**.

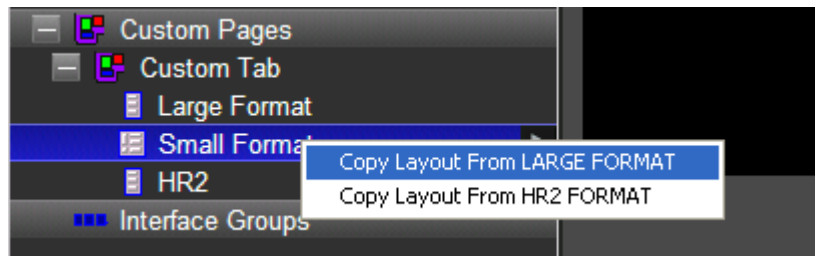

3. Select Yes in the warning message that displays. *There currently is no existing interface for the Small Format, so it's OK to overwrite it.*

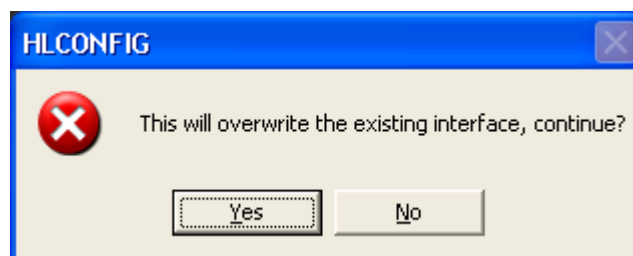

- The custom tab displays in the Small Format resolution.

Note: The custom keypad, buttons, and dimmers are all present, and are already configured as they were for the Large Format resolution but since this interface is smaller some adjustments may be required, particularly when going from landscape to portrait.

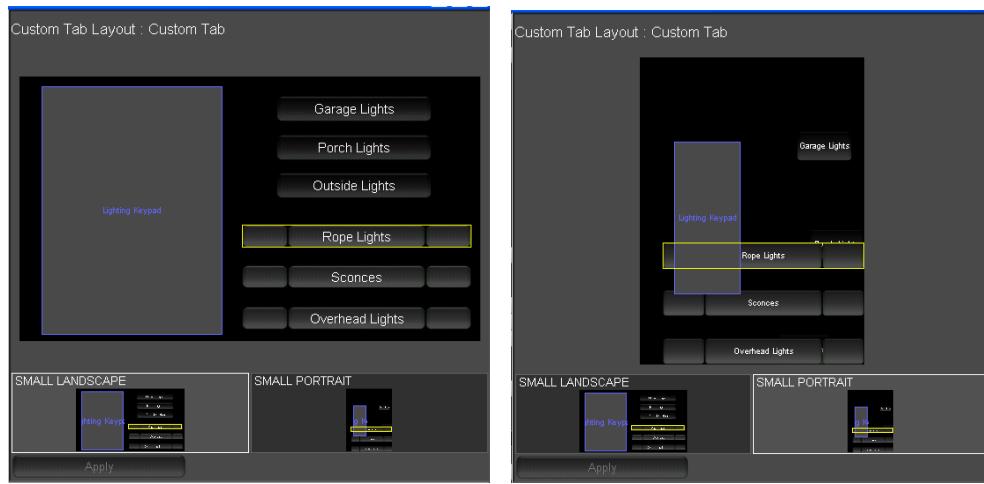

- Use any of the methods described in the previous exercises to rearrange the interface to be more usable for the homeowner.

For example:

- Shorten button names
- Resize the buttons
- Move the buttons and/or keypad

Exercise 7: Set up a Schedule in the Viewer

Overview The lighting schedule is set up in two parts. First, you create a framework or foundation for the lighting schedules in the Configurator. Then the actual scheduling is set in the Viewer, based on the framework created in the Configurator.

Note: You may choose to hide or show the Lighting Schedule interface from certain touch screens using the Interface Devices options on the Interface tab in the Configurator. See steps below for details.

Lighting schedule framework is based on House Modes, such as Home or Away. You may choose to create a schedule for each mode individually; create one schedule for all modes; create a specific number of schedules where more than one House Mode shares certain settings, or disable scheduling entirely.

Lighting Periods are then defined by name in the Configurator to provide different times of the day that Lighting schedule changes are executed. Finally, in the Viewer you will define the time of day for each Lighting Period and add lighting commands to be issued at that time.

In the following example we will setup the system to use two different schedules, one for when the system is in Home mode and the second for when it is in Away mode. For each schedule we will configure three lighting periods.

How-To To configure the number of Schedules to build your framework around:

1. Navigate to the Lighting tab in the Configurator and select Schedule in the System Tree.

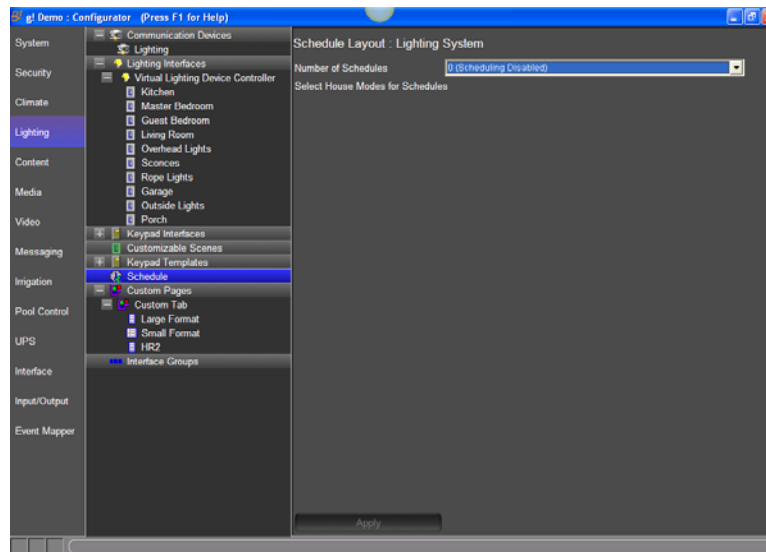

- To edit the number of schedules, click the **Number of Schedules** field. Select **2 Schedules**.

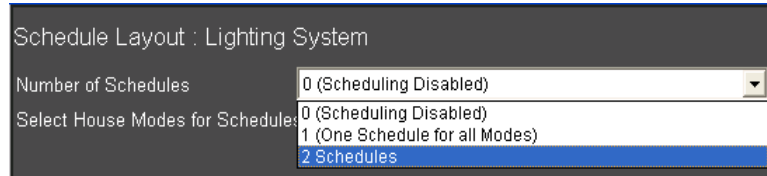

- If some schedules will be shared by more than 1 House Mode, select the appropriate number of schedules. If you want to set a unique schedule for each House Mode, select the same number of schedules as you have House Modes. *(In the above example, we would choose 2 Schedules)*
- To use one Schedule for all House Modes, select 1 Schedule.
- To disable Scheduling on the Lighting tab, select 0 schedules.

- Select Home for schedule 1 and Away for schedule 2 then click **Apply**.

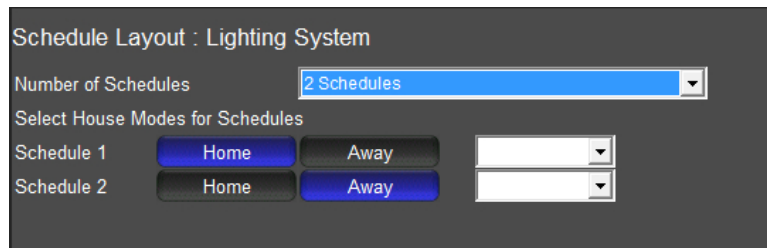

- In this example, the Home mode will use Schedule 1, and the Away mode will use Schedule 2.

- Click the drop down for **Home Mode** in the **Schedule 1** row to add periods to this schedule.

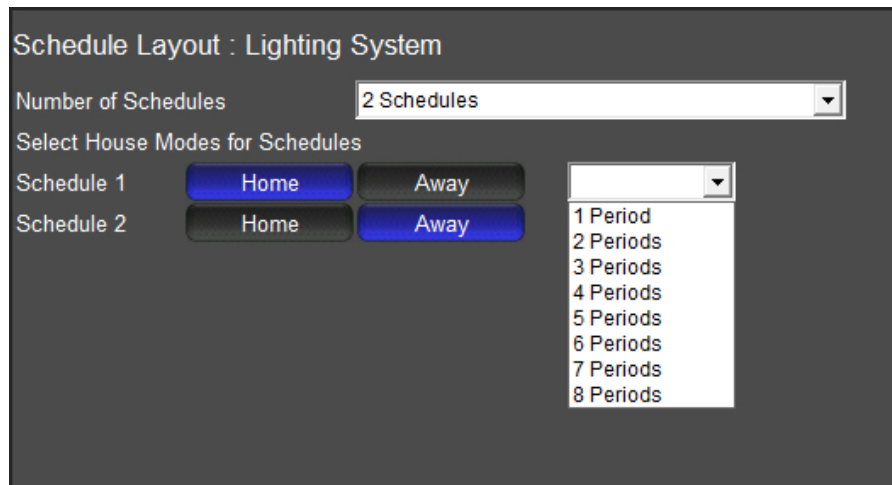

- There may be up to 8 periods per day added to each mode for each schedule. Note that this only creates the framework for schedule periods. The setup for time of day etc. will occur in the Viewer.

- Click **3 Periods** for the Home Mode schedule and then click **Apply**.

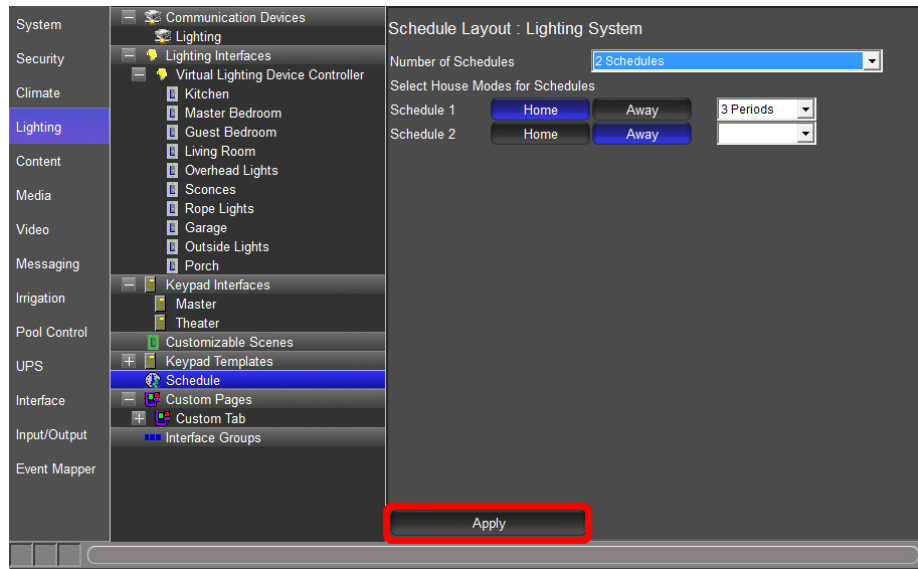

- Repeat the steps above to add **four periods** to the **Away Mode** schedule.

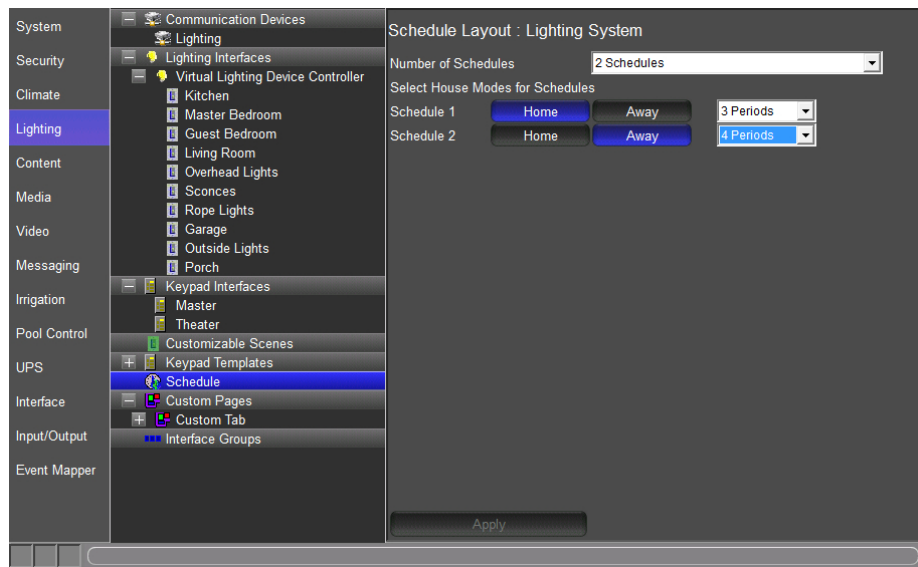

Now that the framework for the Lighting Scheduler is complete, you will configure which screens have access to edit, and view, the lighting schedule user interface.

7. Click the Interface tab to access the Interface Devices (TouchScreen) options, then click the + next to the Windows touch screen in the list.

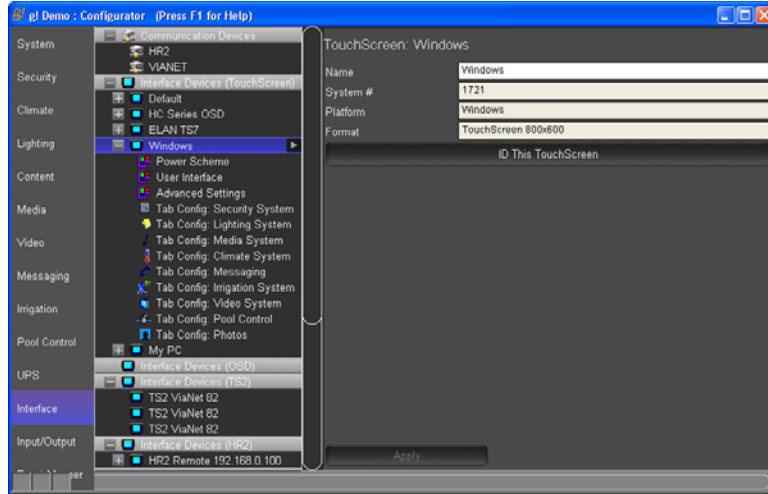

8. Click on the **Tab Config Lighting System** in the system tree to configure the visible lighting devices for your PC.
9. Select the **Builtin: Schedule** item listed in the Available Tabs section then click **Add Tab** and click **Apply** to activate the schedule user interface.

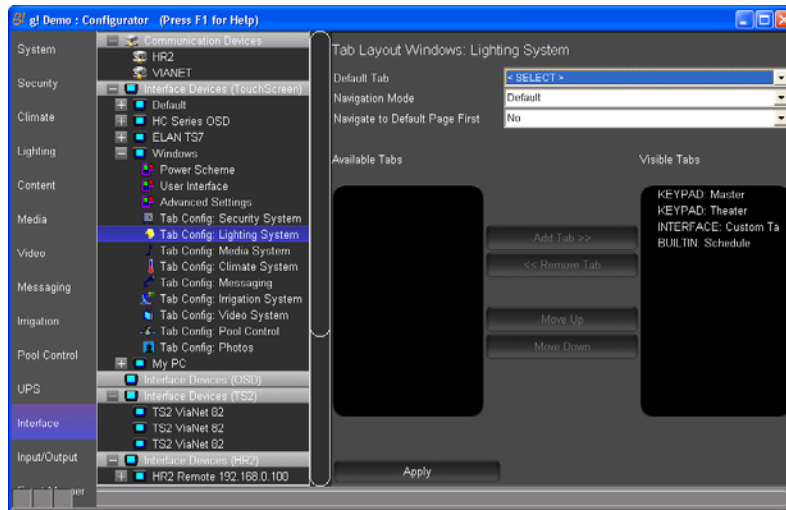

In the following steps, you use the Viewer Lighting Scheduler user interface to configure the lighting commands and the times when they are executed.

10. Start the Viewer, click the **g!** icon to access the main menu, then click the lighting icon to access the available lighting zones.
11. Click the **Schedule** icon to access the Lighting Schedule page.

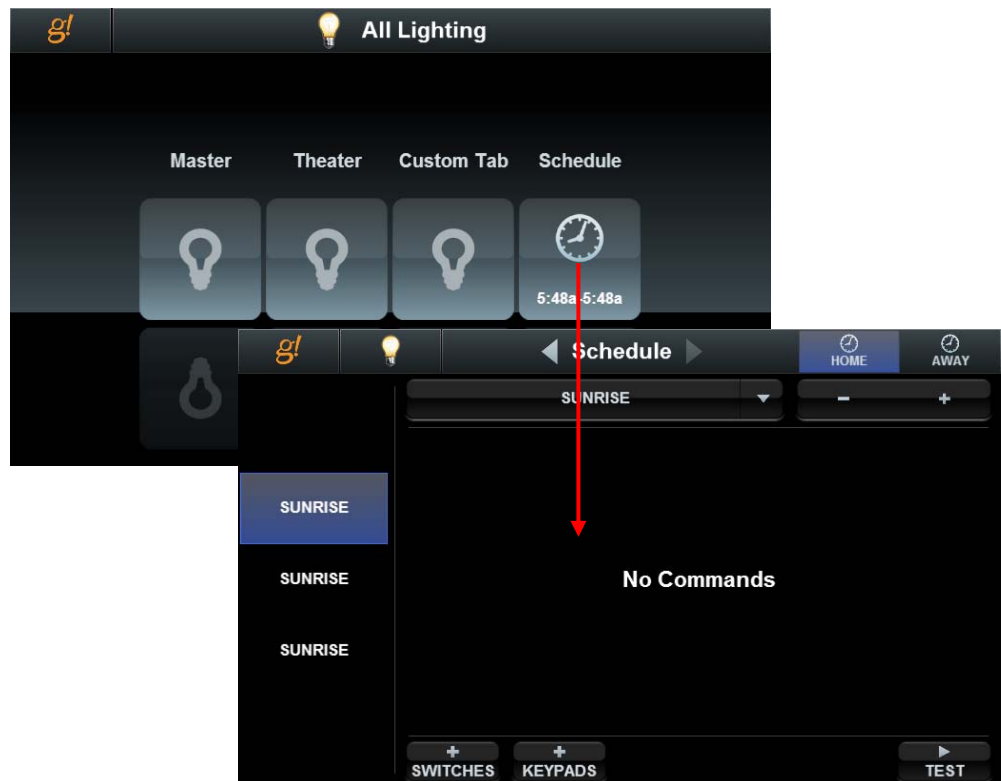

- Notice at the top right you can select to view or edit either configured schedule, with the name depicting the House Modes using that schedule.
- On the left of the main window is each scheduled period showing the time it is set to run. By default, all schedules are set to **Sunrise**.
- For each Period there are controls to adjust the time type, time, add commands to the period, and test the schedule.

12. Configure the start times for each period for the Home Mode. Set the first period to be 30 minutes after sunrise, the second period to be 15 minutes before sunset, and the third period to be at 11:00pm.
 - a. For the first period, since Sunrise is already selected, click the + button twice to set the first period 30 minutes after sunrise.
 - b. For the second and third periods, first select the type of time by clicking the time type drop down in the top center of the scheduler window, and then select "Sunset" or "Clock." Then click the left or right arrows to adjust the increments as desired. For this exercise, set the second period to be 15 minutes before sunset and the third period to use the clock at 11:00pm. Your screen should look like the one shown below.

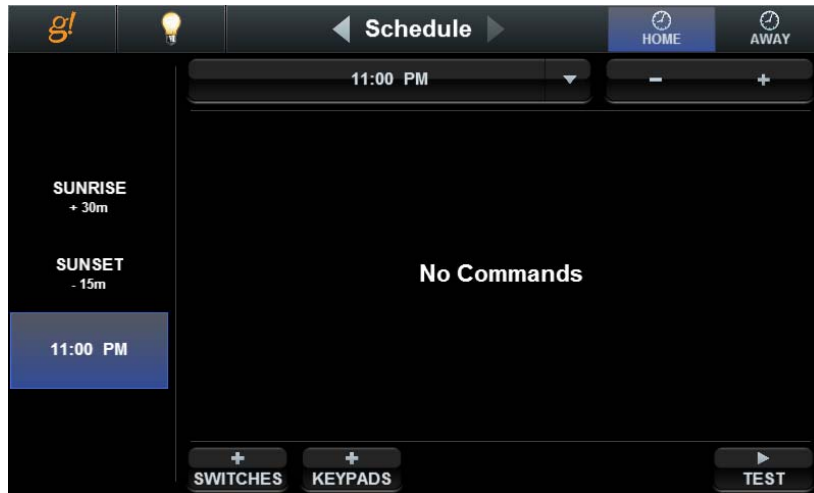

13. Click on the Sunrise period then click the + Switches button at the bottom of the screen to open the Add Commands page.
14. Select the Device **Porch** light, the Command **Off**, and then click + to configure the porch light to turn off in the morning period.

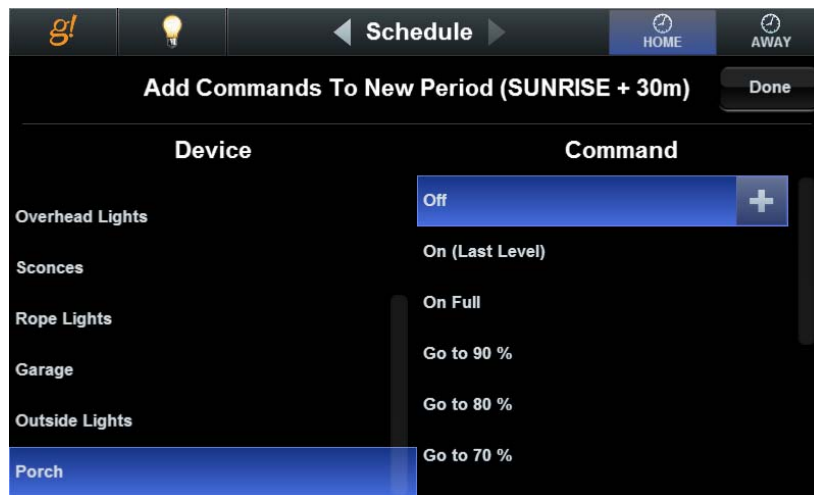

15. Click the **Done** button in the top right to exit the Add Commands page.

16. Repeat the above steps to add the **Porch Lights-On Full** and the **Outside Lights-Go to 70%** to the **Sunset** period.

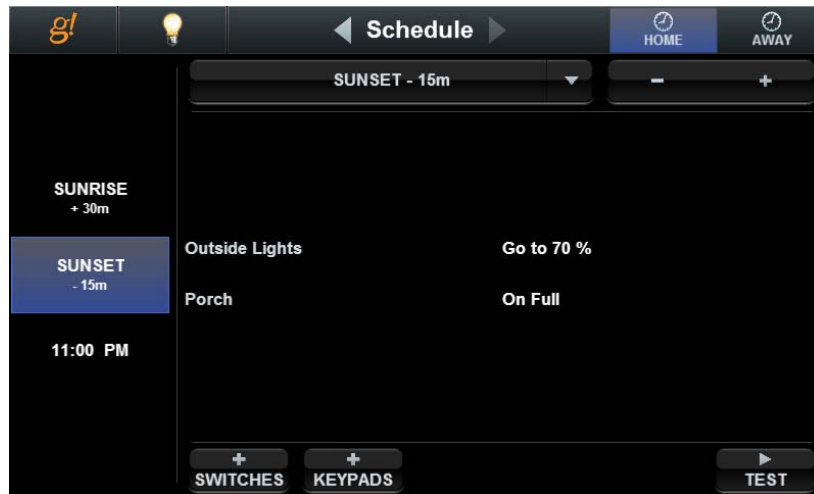

17. Repeat the steps above to add the **Outside Lights – Turn Off** to the **11:00 PM** period. Your Home Schedule should now look like the screen below.

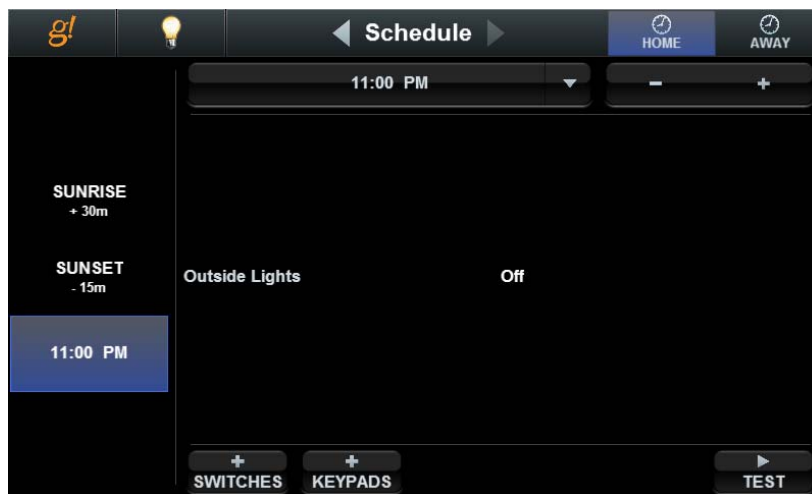

Repeat the steps 11 thru 17 to add the **Away** schedule as follows.

- Period 1: Sunrise +30 min: Porch - Off
- Period 2: Sunset -15 min: Porch – On Full, Outside Lights – Go to 70%
- Period 3: 8:15 pm: Living Room, Kitchen, Master Bedroom – all On Full
- Period 4: 11:30pm: Living Room, Kitchen, Master Bedroom, Outside Lights – Turn Off



Lesson 6

Distributed A/V Systems: Part 1



Overview

This lesson shows you how to set up a distributed A/V system with four music sources distributed to 2 listening zones.

You will:

- Learn how a multi-zone audio system is organized in the Configurator.
- Configure a zone controller for six zones and add sources.
- Configure the zones.
- Check the Viewer interface to confirm proper configuration.
- Understand the various features available in the Viewer.

Sample House

Our sample house will be configured with two distributed A/V zones:

- Living Room
- Bedroom

Requirements

- A PC running g!Demo and g!Tools.

-or-

- g! system controller and g!Tools.

Distributed A/V Integration Overview

Overview The following diagram shows the equipment in a four source / two zone distributed Audio system schematically, illustrating the components that are important to the g! system controller. In our example we will be using a g! system controller to control, the audio output from a g1 in extender mode, and an ELAN DT11 dual tuner for sources as shown below.

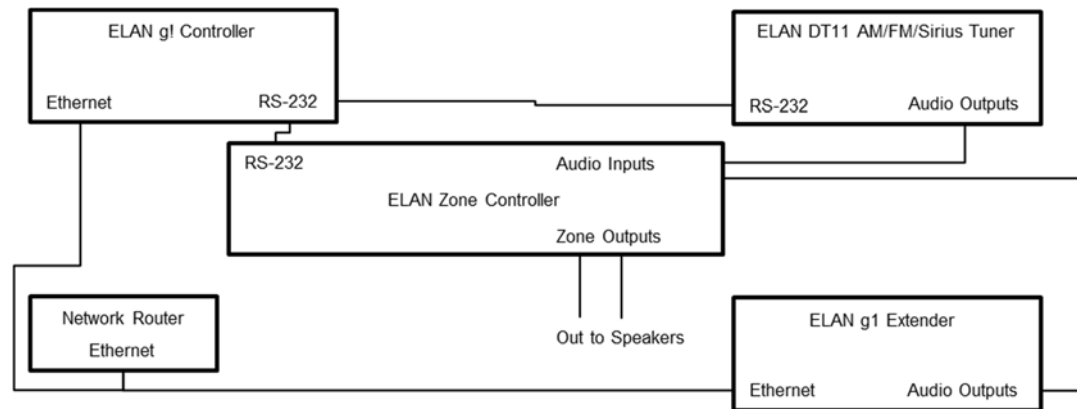

Integrating a distributed Audio system with g! will provide the homeowner control of their audio system through the g! Viewer. For each audio zone in their home, they can:

- Turn the zone on and off
- Select and control a source for the zone
- Adjust the audio volume in the zone
- Change the zone settings, such as bass and treble

Terms The following terms are used in the Configurator to describe the equipment in an audio system:

- **Communication Device:** The method the g! software will use to communicate with an external device, including information about the connection type and protocol.
- **Audio Zone Controller:** The device used to distribute audio throughout the home.
- **Keypads and Interfaces:** A custom defined interface for controlling audio source components.

How-to Integrating a distributed audio system with g! consists of the following steps:

- Add and Configure **Sources**.
- Add the **Communication Device**
- Add the **Zone Controller** for the distributed audio
- Configure the **Audio Sources** and **Zones** in the audio zone controller.

Exercise 1: Setup the Content Tab

Overview In Exercise 1, you will set up a music library to use with the Internal Player. This source is used to play digital music (MP3, unprotected AAC/M4a, or WAV files) through the g1 controller audio output as a source to an audio zone controller. Please refer to the g1 *Internal Player Integration Note* for more detailed information.

How-to 1. Digital Music Library Setup (non-iTunes)

When setting up a library of music to use with the internal player, it is best to setup files as follows:

File Structure	<p>File Structure is expected to be: "Artist Name\Album Name\Music files".</p> <p>In other words, make directories for each artist. Within each artist directory, place folders for each album. Within the album folders, place the music tracks for that album. Though ID3 info is read and used to sort tracks, keeping files in this structure makes the files much easier to browse on their own, and ensures that correct artwork will be used.</p> <p><i>Note that file structure is very important for WAV files, as WAV files do not contain any ID3 information and g! will populate the Artist/Album/Track information from the folder names when the folders are arranged in this format</i></p>
MP3 Tags	Files should be appropriately tagged with ID3 information for Artist, Album, Track, and Track number. Other information such as composer or embedded album art is not used at this time, but may be included if desired.
Album Art	<p>Album art should be placed in the Album folder (if available). Note that the expected art format is JPEG, and the largest JPEG image in the folder will be used by default. File name is not important, though typically "folder.jpg" is used.</p> <p>If no art is available in the folder, g! will automatically look up art from internet sources based on the ID3 information. Note that art found on the internet may not be correct, and can vary in quality so populating art prior to integrating your music library as explained above is preferred. See Common Mistakes below for tips on correcting any issues.</p>
Additional Files	Some music libraries may contain additional files, such as lyrics or guitar tabs in the folder. These files will not be used and may be omitted.
WAV Files	WAV files must be uncompressed.

2. Add Network Shares to a g Controller

Network shares can be added to the g1 as a music source. Network shares should either be on a computer that is on 24 hours a day, or better yet, on a NAS drive. It is recommended to use a NAS drive installed by the dealer, as this drive will only be used for network storage for the g Controller, will be on 24 hours a day, and is a part the installer may be familiar with and in control of. NAS drives or network shares must be available on the same subnet as the g Controller, and must be configured without authentication (username/password) for access. Be sure to scan shares when finished adding music; see **Scanning Shares** below.

- a. To add new music network share folders (not iTunes) click on the Content tab of Configurator.
- b. Right-click “Audio Share Folders” and “Add New Audio Share Folder”.
- c. For music stored on a NAS drive, enter the information as below:

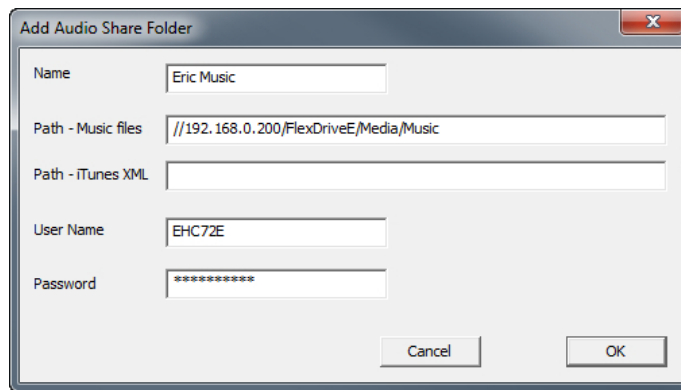

Name	Enter a name for your reference, or duplicate the path.
Path- Music Files	Enter the network path. Linux is typically formatted like //IPAddress/sharefoldername.
Path- iTunes XML	Leave Blank for non-iTunes libraries. (see iTunes below for iTunes libraries)
Username	This is an unsupported feature. Use open shares.
Password	This is an unsupported feature. Use open shares.

Note: The new g System Controllers feature a Linux based operating system and mapping a file share path on the network must meet these conditions:

The IP Address of the server must be used in the file path, not the network name.

Correct: //192.168.0.200/ | Wrong: //Eric_PC/

The full path is case sensitive and must not use any spaces or special characters in the name of the share path.

Correct: //192.168.0.200/FlexDriveE/Media/Music | Wrong://192.168.0.200/My Music

- d. Scan the share folder.

3. Scan library.
 - a. Navigate to the **Content** tab in the Configurator. In the System Tree, locate **Audio Library Scan Options, Audio Share Folders**.
 - b. Right-click on, or select the Arrow Box to the right of, the Audio Share Folder. When using g! Demo right click on, or select the Arrow Box to the right of, **C:\MUSIC** directory and select **Scan Share Now**. *The Configurator scans the sample music in this directory to build a library for the Internal Player.*

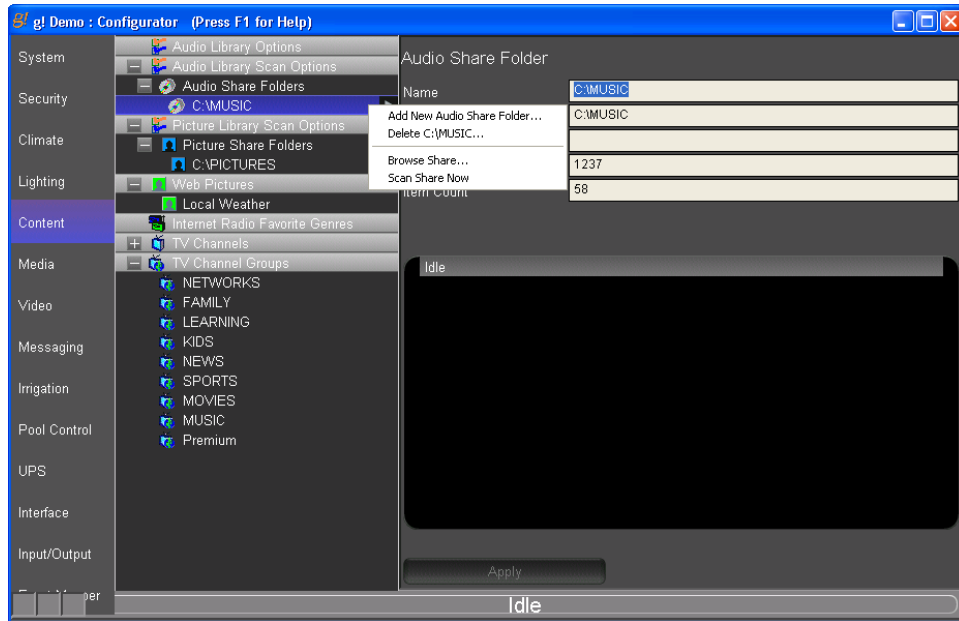

Note: The g!Demo installer will add sample music to the C:\Music directory to provide a sample library for the Viewer during training class. If you are not running the g!Demo you may need to add music to have the system find it. Shared drives on the local network may also be used as music libraries.

4. Once the scan is complete, verify that there are files in the audio share folder.

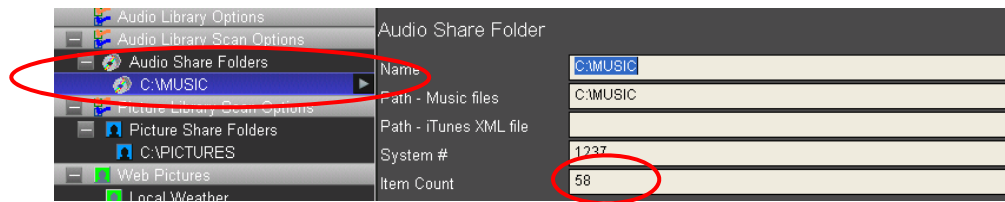

Exercise 2: Configure the Internal Player

Overview In Exercise 2, you will configure the g1 Internal Player and add music files. This source is used to play digital music (MP3, unprotected AAC (m4a), or WAV files) through the g1's audio outputs as a source to an audio zone controller. This source includes a built-in two-way driver and built-in interface.

- How-to*
1. Configure the g1 as an MP3 Player when in Extender mode.
 - a. Navigate to the Media tab and select the "Sources" node.



- b. Select the **Arrow Box** to the right and select **Add New MP3 Player**.
 - c. **Name** the g1 Internal Player and select the **Device Type** of g1 Extender Player, and select **OK** when finished.

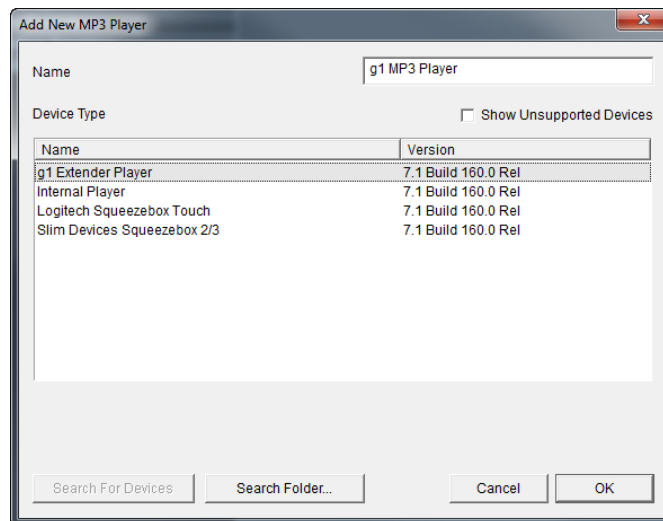

- d. Select the **Settings** drop down and choose **HDMI on g1** or the **Analog on g1** option to set where the audio signal gets sent out. Select **Apply** when finished.

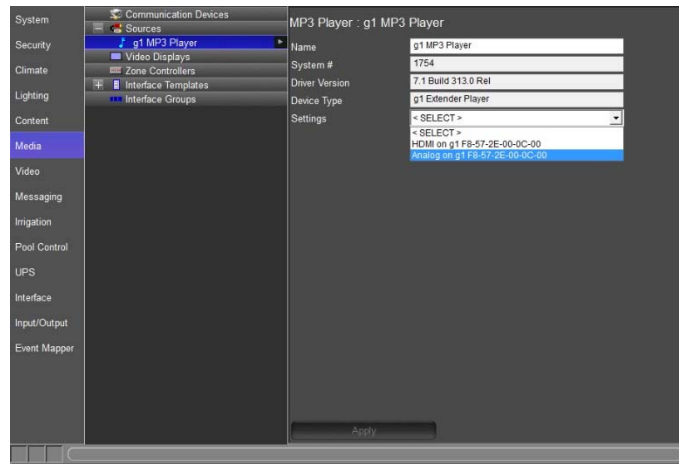

Note: When using multiple g1's as extenders note the MAC address of each g1 to ensure that each unit is setup correctly.

- 2. Navigate to the Content tab and scan the library as described in Exercise 1.

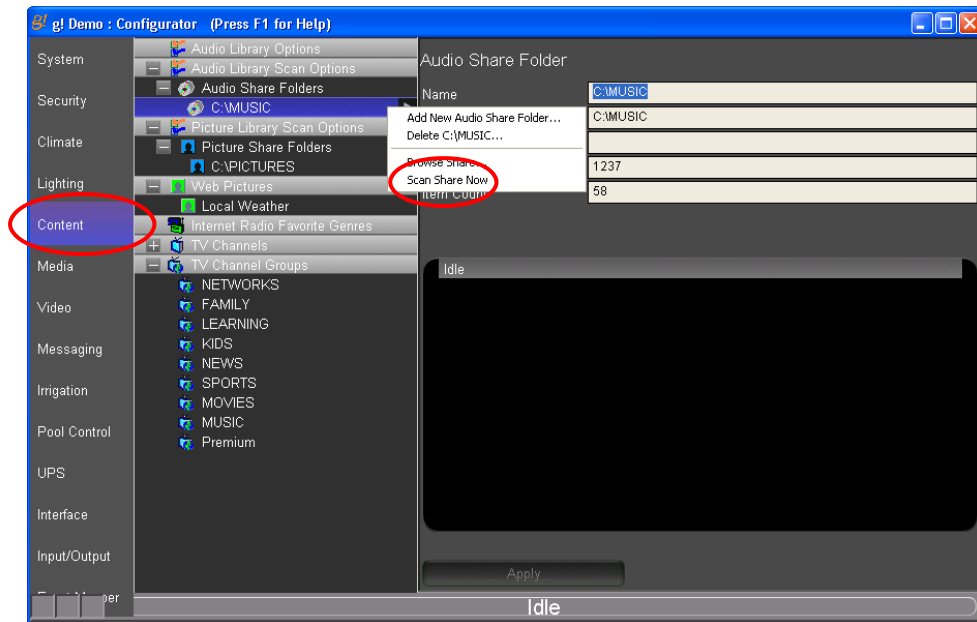

How-to

1. Configure the g1 as an MP3 Player when used as a system controller.
 - a. Navigate to the Media tab and select the “Sources” node.



- b. Select the **Arrow Box** to the right and select **Add New MP3 Player**.
 - c. **Name** the g1 Internal Player, select the **Device Type** of **g1 Internal Player**, and select **OK** when finished.

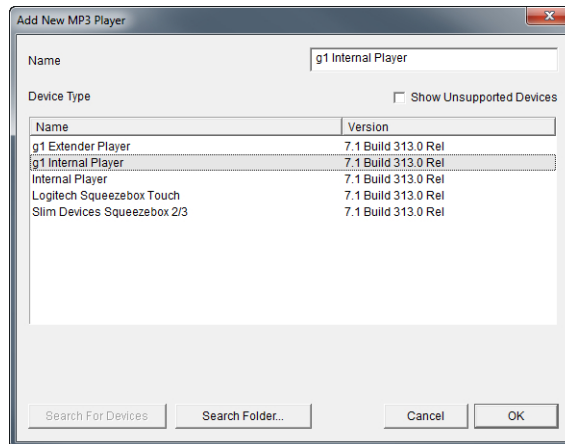

- d. Select the **Settings** drop down and choose **HDMI on g1** or the **Analog on g1** option to set where the audio signal gets sent out. Select **Apply** when finished.

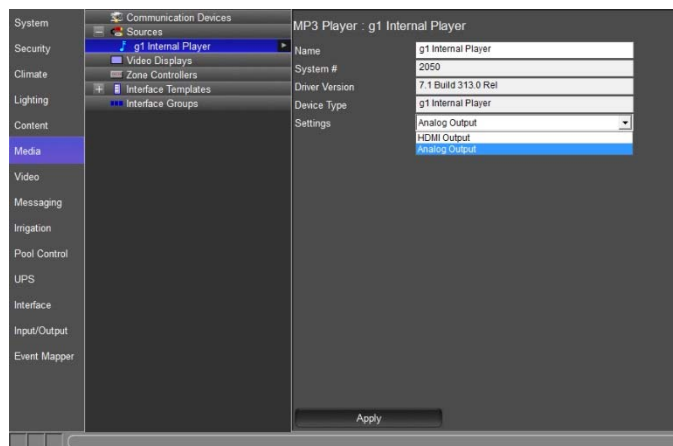

Note: When using multiple g1’s as extenders note the MAC address of each g1 to ensure that each unit is setup correctly.

2. Navigate to the Content tab and scan the library as described in Exercise 1.

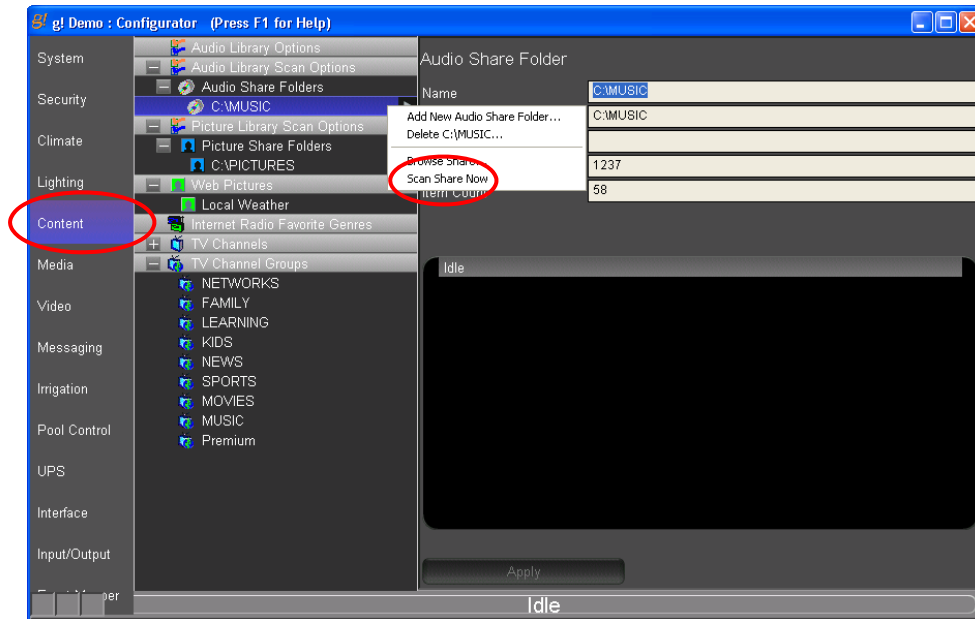

Exercise 3: Add an RS-232 Source with a Built-in Driver & Interface

Overview In Exercise 3, you will configure an ELAN DT11 Dual Tuner. This device is an example of a source with a built-in two-way driver and a built-in interface. This means that the g! software includes the necessary serial commands to control the tuner and has a built-in interface with all control and feedback automatically configured. Just add the device and you are done—there is no need to create an interface.

Note: For a complete listing of supported devices with built-in drivers, refer to the ELAN website for a listing for all supported devices and links to *Integration Notes* for each.

How-to

3. Add the communication device.
 - a. Start the Configurator, click the **Media** tab, and then right-click **Communication Devices**.
 - b. Select **Add New Communication Device**. In the dialog box:
 - i. Enter “DT11” as the **Device Name**
 - ii. **Communication Type** select **ELAN DT11/DT22 Tuner (RS-232)**
 - iii. **Hardware Type** select **Serial Port**
 - iv. Select an **Unassigned COM Port** in the **COM Port** drop-down box

Note: The drop-down menu shows all COM ports and indicates if a port is in use. Leave the selection set to **NONE** if you are using **g!Demo**.

- v. Click **OK**

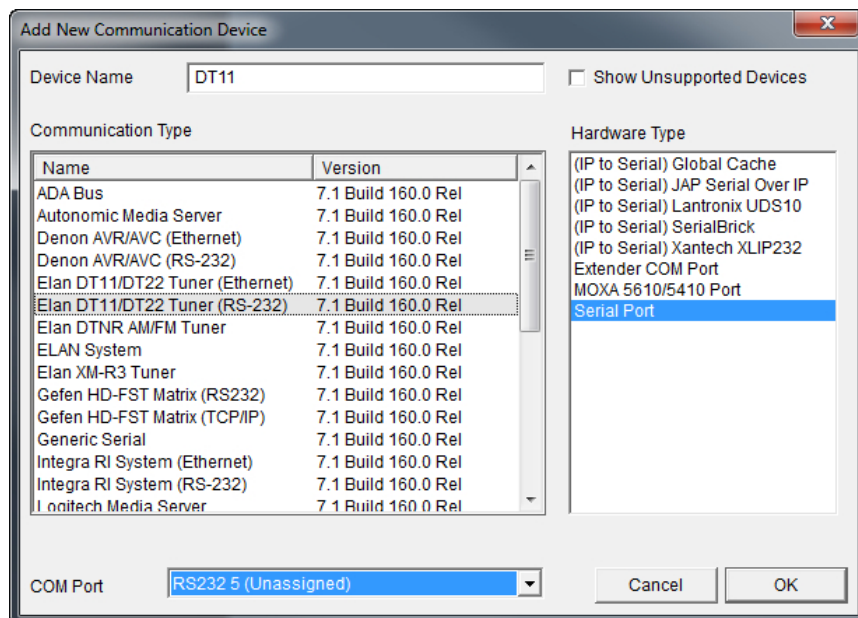

4. Add the ELAN DT11 to the Sources node. Since there are two tuners in this device, we will add two tuners to our system configuration.
 - a. On the System Node Tree, right-click **Sources**. Select **Add New Tuner** from the menu. *The Add New Tuners window opens.*

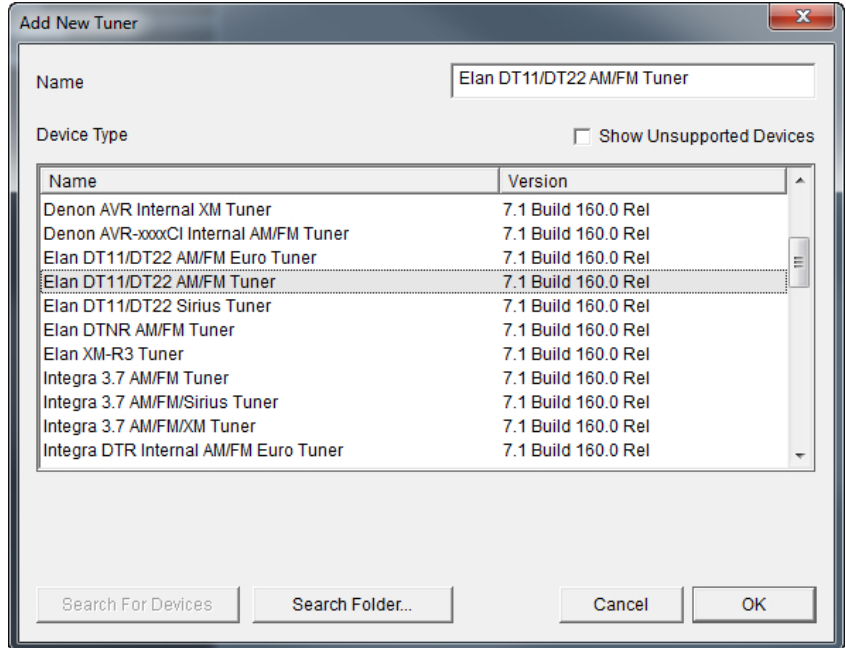

- b. Select **ELAN DT11/DT22 AM/FM Tuner**, and click **OK** to add the tuner. *The tuner is added to the System Tree and automatically connects to the COM Device.*

5. Select the **Tuner** in the System Tree. In the properties window:
 - i. Change the name to **AM/FM Tuner**
 - ii. Set the **Tuner ID** to **1**
 - iii. Click **Apply** to save.

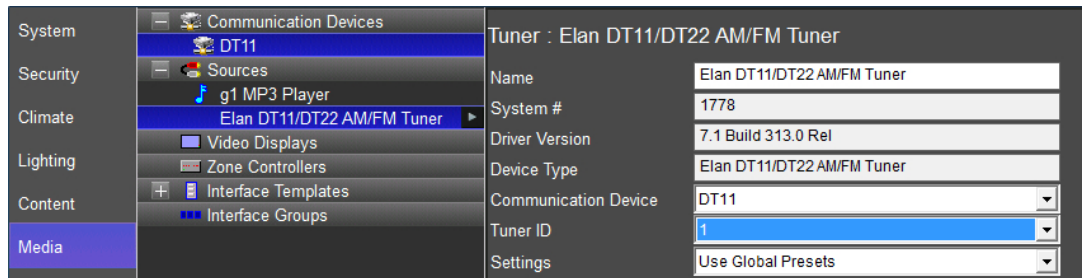

6. Repeat Step 3 to add the **ELAN DT11/DT22 Sirius Tuner**. *The tuner is added to the System Tree and automatically connects to the COM Device.*
 - i. Change the name to **Sirius Tuner**
 - ii. Set the **Tuner ID** to **1**
 - iii. Click **Apply** to save.

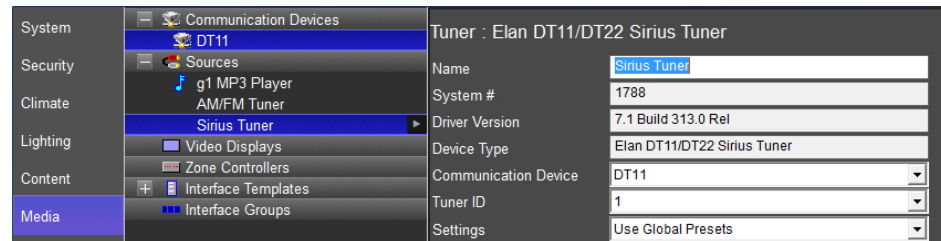

Note: The Dual Tuner configuration is now complete. Since this device has a built-in interface, it can be directly configured as a source in a zone controller. In the following lessons you will add this device as a source to a zone controller and be able to see it in the Viewer.

Exercise 4: Add the Audio Zone Controller

Overview In Exercise 4, you will add an Audio Zone Controller. For this training, we will add an ELAN S86A (6 Zone) Audio/Video Zone Controller. The S86A communicates with the controller using RS-232, so you will need to add a Communications Device before adding in the Audio Zone Controller.

In a distributed A/V installation, the zone controller is the heart of the whole house audio/video system.

Note: The main **Media icon will not appear** in the Viewer until a zone controller has been added in the Configurator Media tab, and at least one zone has been added in the **Interface tab** (Interface Devices> Tab Config: Media System).

In the steps below, you will add an ELAN S86A (6 Zone) multi-room audio/video system to the Configurator.

Note: Actual system setup may be different based on the audio equipment installed on site. Refer to the *Integration Notes* for the particular details for your system.

How-to

1. Add the communication device.
 - a. Start the Configurator, click the **Media** tab, and then right-click **Communication Devices**.
 - b. Select **Add New Communication Device**. In the dialog box:
 - i. Enter “S86” as the **Device Name**
 - ii. **Communication Type** select **ELAN System**
 - iii. **Hardware Type** select **Serial Port**
 - iv. Select an **Unassigned COM Port** in the **COM Port** drop-down box

Note: The drop-down menu shows all COM ports and indicates if a port is in use. Leave the selection set to **NONE** if you are using **g!Demo**.

- v. Click **OK**

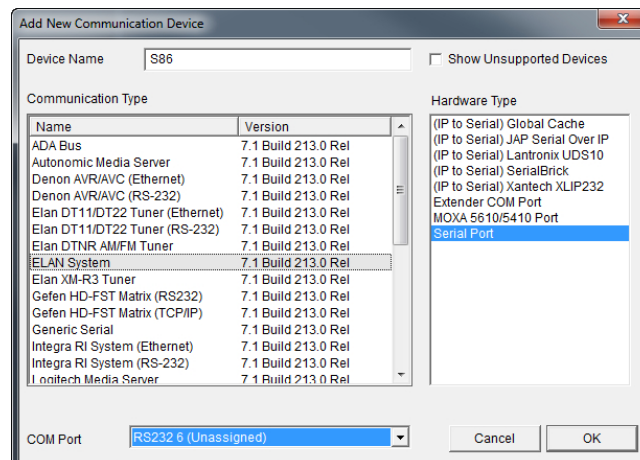

2. Right-click **Zone Controllers**, then click **Add New Zone Controller**. *The Add New Zone Controller window opens.*
3. Select **ELAN S86A/P** as shown below, and then click **OK**.

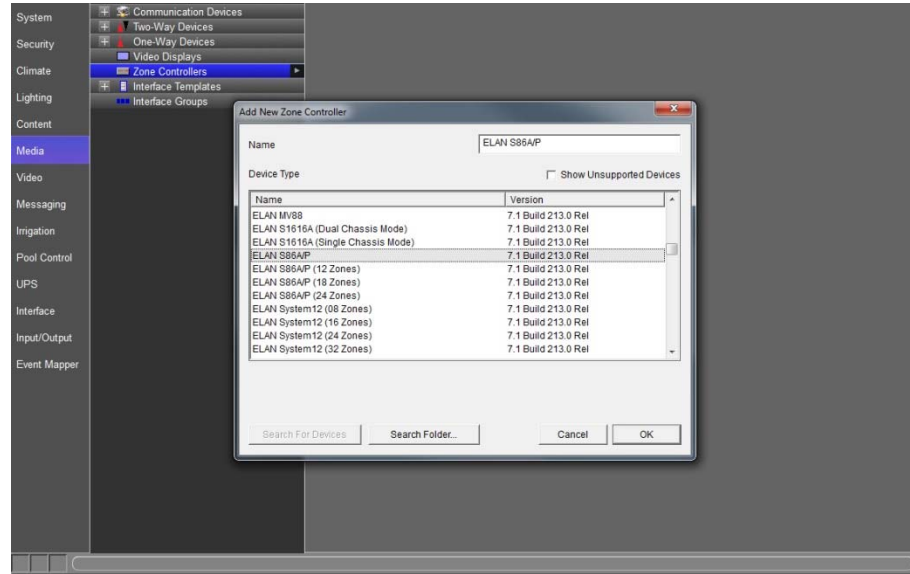

4. Select the **ELAN S86A/P** zone controller in the System Tree and verify the communication device in the properties window. *The Communication Device should automatically be selected for the Zone Controller.*

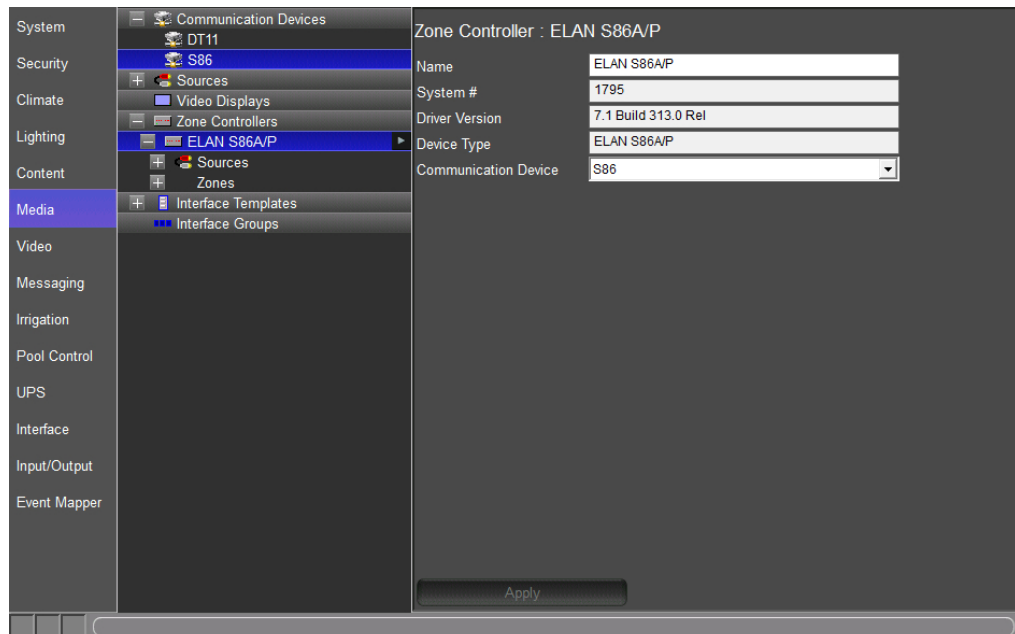

Exercise 5: S86A/P Source Settings

Overview Exercise 5 describes how to set up the Source Volume and IR routing settings on an ELAN S86A.

Source Volume settings are used to equalize the sound levels for each selected source to prevent the user from needing to adjust the volume up or down for each source selected. The IR routing table defines how IR will pass thru the S86 chassis.

Note: The settings described in this exercise are only available for ELAN equipment.

How-to

1. Start the **Configurator** and click the **Media** tab at the left.
2. Select **Sources** under the **ELAN S86A/P**. *The Source Setting Matrix is shown in the properties pane to the right.*
 - Click in the IR routing table to change the IR routing in the chassis.
 - Right click the values in the Audio Input column to change the volume level for the selected input.

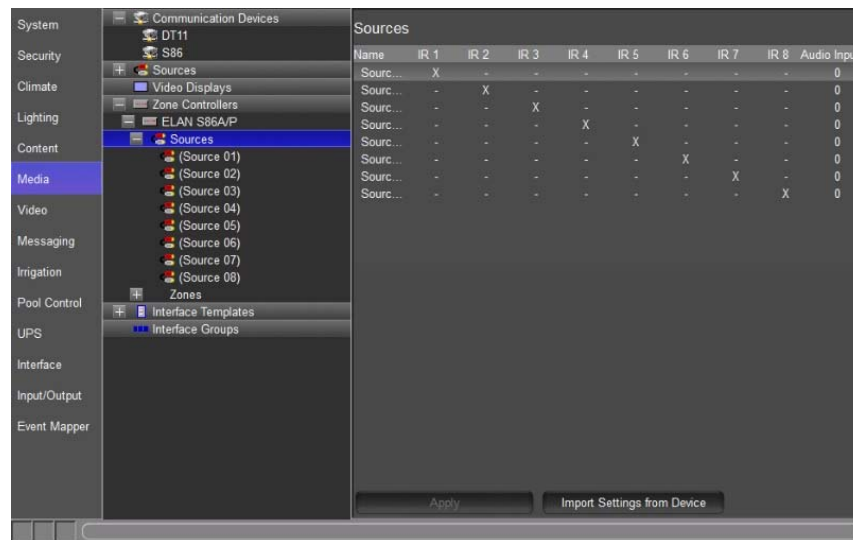

Note: IR devices connect directly to the System Controller. IR routing is only used with 3rd party control systems. See the Quick Reference: S86A/P Source Settings on the next page for more information on the S86's IR Outputs.

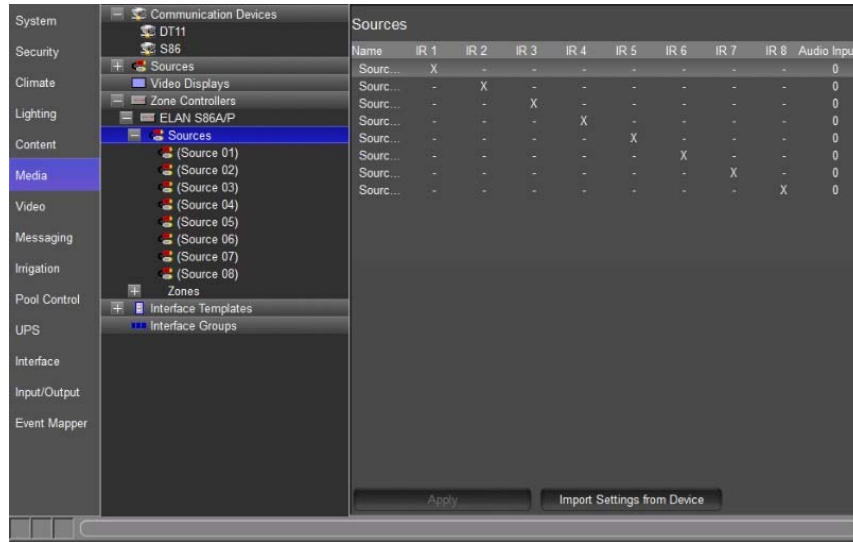

Quick Reference: S86A/P Source Settings	
Source Name	The names of the sources. See the source exercise below for more details.
IR 1-8	IR routing matrix. This matrix allows configuration of IR routing through the S86 chassis. Note: These setting have no effect on IR outputs from Global Cache or g! System Controllers. Select the IR output jack for each source. An "X" indicates that IR received by the chassis zone input will be passed to that port when the selected source is active. In the screen above, for example, if IR is received to control source 2, AM/FM, the IR will be routed to IR output 2.
Audio Input	The source volume level. Use these adjustments (+ / -) on each source to maintain equivalent source volumes throughout the system.
Import Settings from Device	(Optional) If the chassis has already been configured, click this button to read in the existing settings from the device.

Exercise 6: Add Sources to the Zone Controller

Overview In a typical installation, sources are assigned to specific inputs on the zone controller. The g! software needs to know which sources are assigned to each input so that the correct signals can be sent to the zone controller based on user input in the Viewer interface. This procedure is the same for most supported Zone Controllers.

For Exercise 6, you will configure the four audio sources added in Exercises 2 and 3.

- Sources 1 and 2 will be the Internal Players.
- Sources 3 and 4 will be the two audio feeds from the ELAN DT11.

How-to

1. In the **Media** tab System Tree, click the plus (+) sign next to **Sources** to expand the Source List for the ELAN S86A/P zone controller added in Exercise 2.

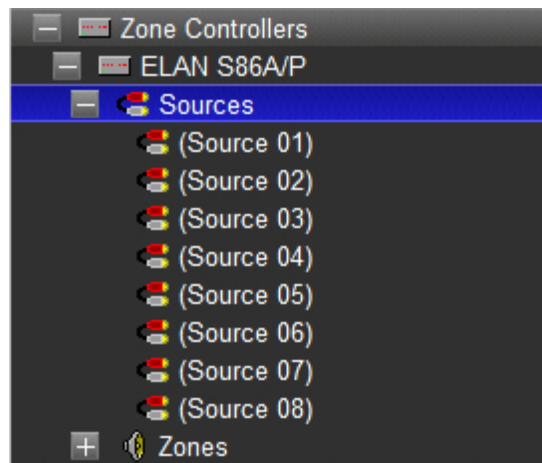

Note: The names shown for sources should match the input names printed on the back of the zone controller

2. Select **(Source 1)** from the list of available sources. *The properties for (Source 1) display in the window on the right.*

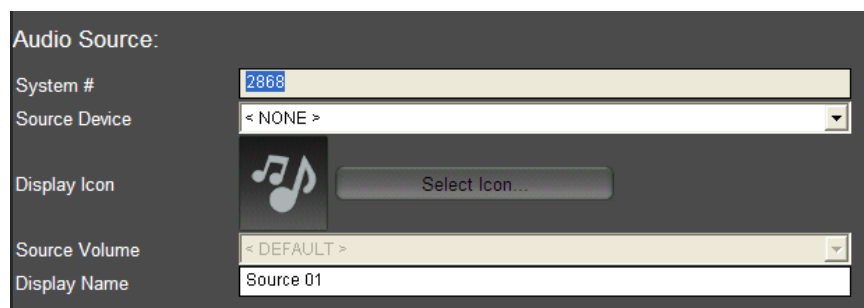

3. Select **MP3 Player: g1 MP3 Player** from the **Source Device** drop-down list as the source device for (Source 1), then click **Apply**. *The (Source 1) entry in the System Tree changes to show its association with the MP3 Player, and the Player itself is highlighted to indicate that it is the device referenced by the source.*

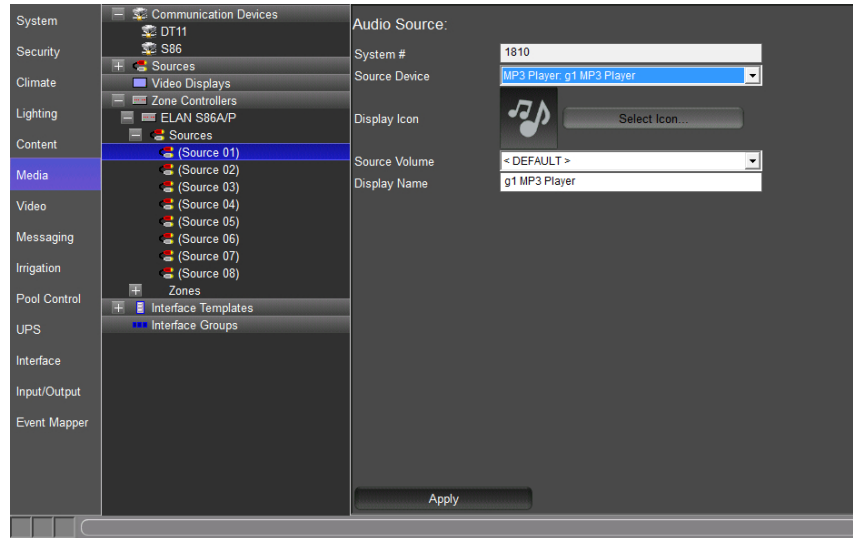

Note: To ensure proper control, the source devices must be connected to the same physical input that is specified in the Configurator.

4. In the properties window, click the **Select Icon** button. *The Select Icon window opens.*

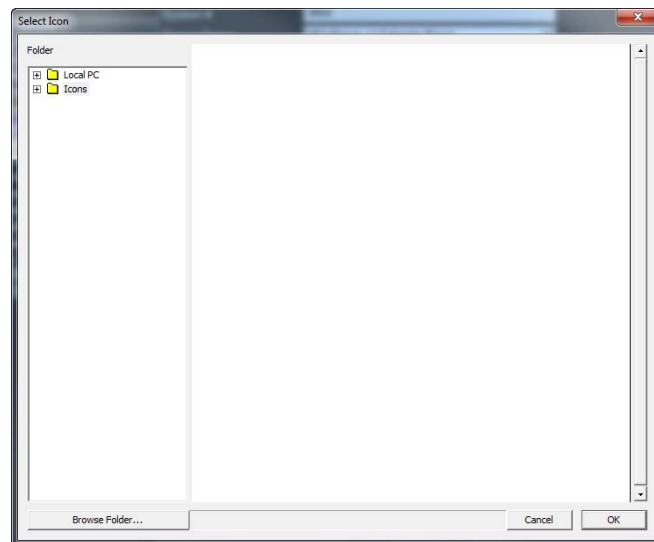

5. Click the plus (+) sign next to the Icons folder, then select the **Media** subfolder. Use one of the icons that display in the window, or navigate to the Color or Gray folders to see more options. Select the icon you wish to use for the source and click **OK**.



6. Change the **Display Name** entry to something more user-friendly, like “MP3 Player”. *The Display Name is what will appear in the Viewer.*

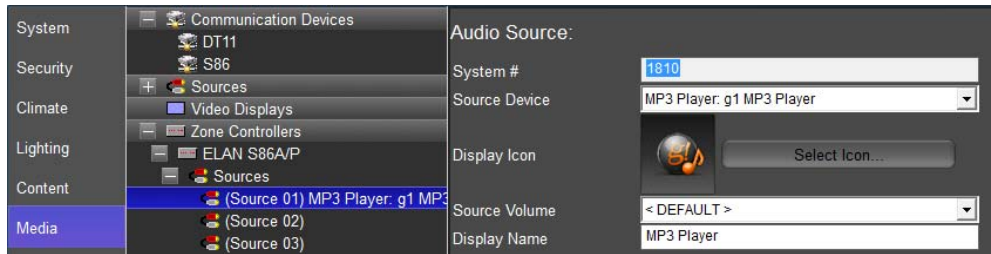

7. Select Source 2 on the S86A/P to add the DT11 AM/FM Tuner.
 - a. From the Source Device drop-down, choose “**Tuner: Elan DT11/DT22 AM/FM Tuner**”
 - b. Assign the Tuner an appropriate icon
 - c. Change the Display Name of the Tuner, if desired.
 - d. Click **Apply**.

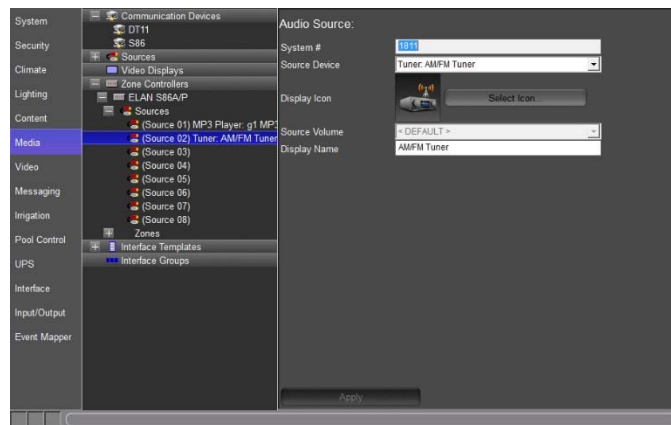

8. Repeat step 8 to add the DT11 Sirius Tuner as Source 3. Give the tuner a descriptive name, such as “Sirius Tuner.”

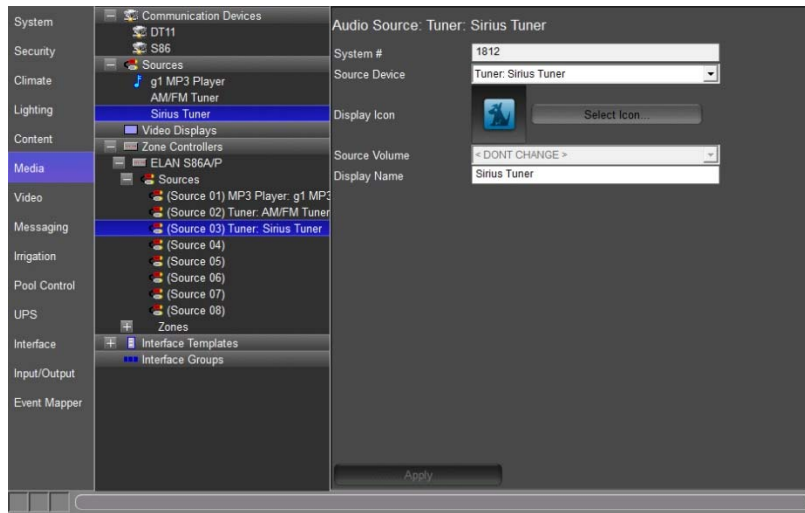

Exercise 7: Configure Zones

Overview In Exercise 7, you will set up the Zone Names and Settings pages for the Zone Controller, and remove unused zones from the Viewer interface.

Giving the zones user-friendly names, such as “Living Room” and “Bedroom” for our sample house, will provide the homeowner with an intuitive interface for controlling the audio in their home.

The optional settings interface gives the user access to less commonly used functions, such as bass, treble, Whole House Audio, Do Not Disturb, and loudness.

- How-to*
1. In the **Media** tab System Tree click the plus (+) sign next to **Zones** to expand the Zone List for the ELAN S86A/P zone controller added in Exercise 4.

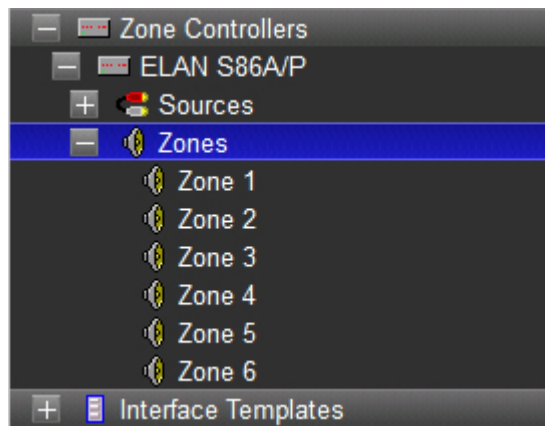

2. Click on **Zone 1** in the zone list to display its properties on the right.
 - a. In the **Name** field, type the name of the first zone in our Sample House, “Living Room”, and click **Apply**. *The label of the zone will change in the Zone List to reflect the new name.*
 - b. Repeat Step 2 for Zone 2, to change the name to “Bedroom”, your screen should look as below.

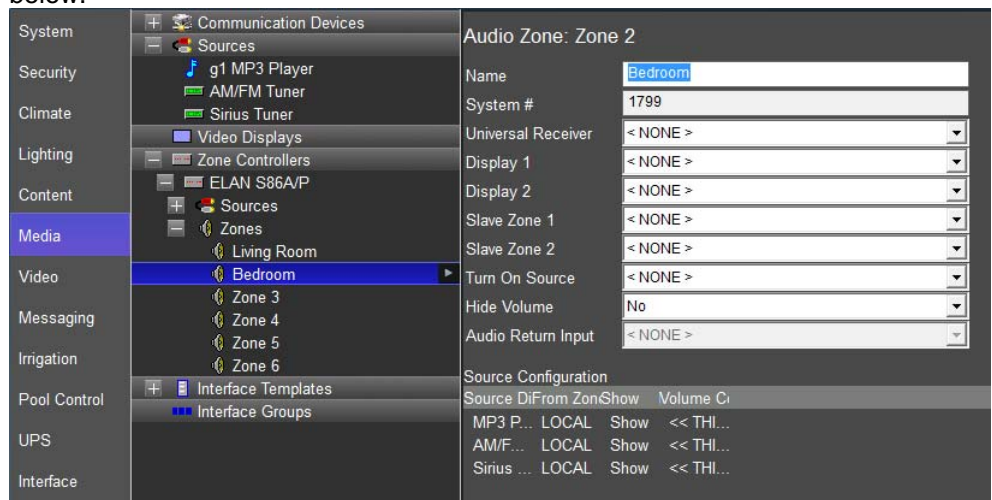

3. To add the optional Zone Settings page, right-click the Living Room zone and select **Create Settings Page for this Zone**.

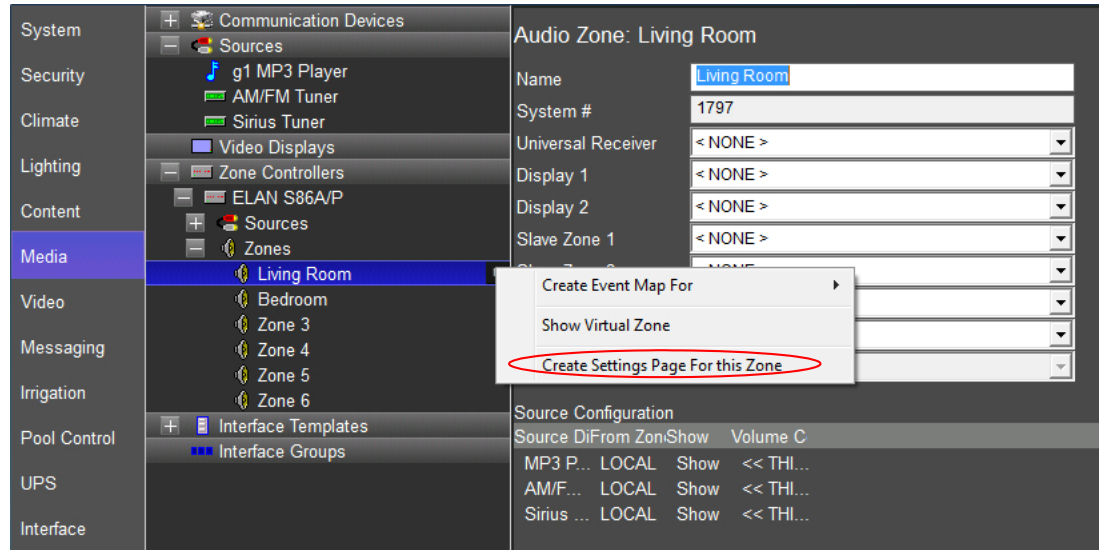

4. A new entry is added the Living Room zone in the System Tree called Living Room: Settings. Click the plus (+) sign to the left of **Living Room: Settings** to expand the list.
 - a. Select **Large Format**, and then select **Large Landscape(Standard)** to display a representation of the settings pages for this zone.

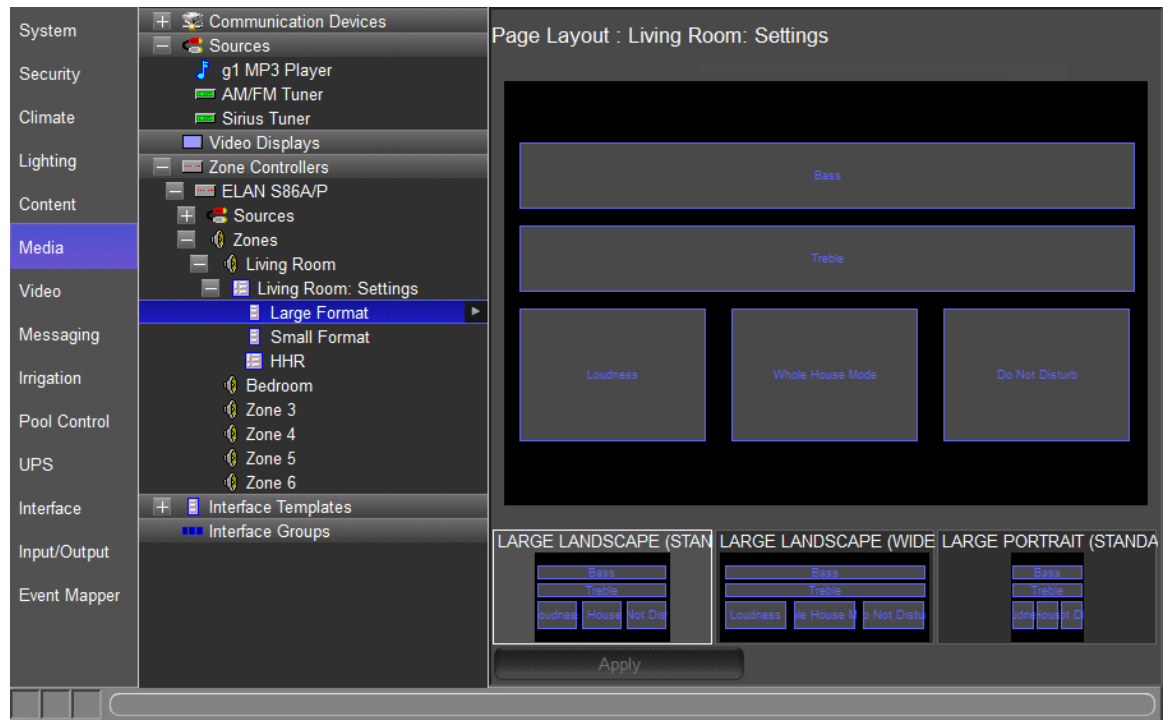

- b. Select **Loudness** on the lower left of the Interface Layout. *The control is highlighted in yellow and the Audio Mode Control Properties window opens.*
- c. Note the following in the **Audio Mode Control Properties** window:
- The **Name** field is set to “Loudness”. This corresponds to the label on the control.
 - The **Style** drop-down is set to **Loudness**.
 - The **Connect To** drop-down is set to “Living Room”, indicating that this is the zone the toggle controls:

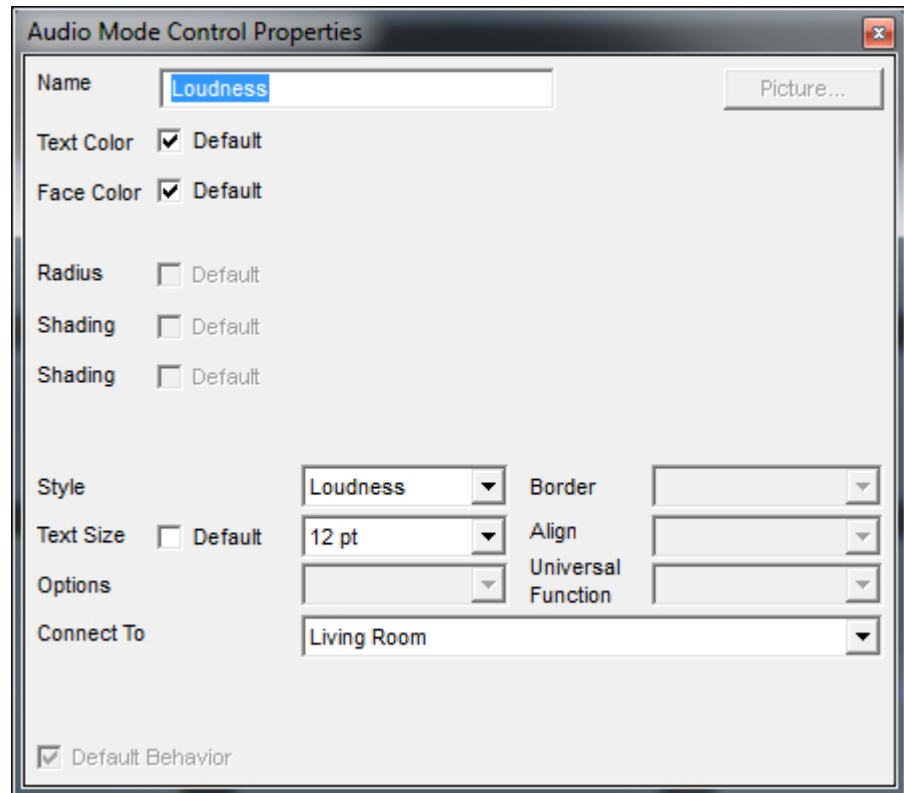

Note: The Settings page is fully customizable and any of the objects on this page can be moved and resized so that controls can be added if needed.

Exercise 8: S86A Zone Settings

Overview Exercise 8 guides you through setting up the default behavior for individual zone volumes and paging behavior on an ELAN S86A/P.

There are five volume settings for each zone on the S86A/P- **Max Volume, Min Vol Turn On, Max Vol Turn On, DB Volume, and Page Volume.**

The ELAN S86A/P includes paging functionality that can be used in conjunction with a C2, Communications Controller, for doorbell and intercom Communication throughout the home.

There are also controls to adjust balance, and toggle zone enrollment in Whole House Music and Doorbell functions.

Each of these settings will be discussed in more detail below.

Note: The settings described in this exercise are only available for ELAN equipment.

How-to

1. In the Configurator, go to the **Media** tab.
2. In the System Tree, locate the **ELAN S86A/P** under Zone Controllers and click on **Zones**.
The Zones volume and paging settings are displayed in the properties window on the right:

The screenshot displays the 'Zones' configuration window. At the top, there is a table with the following columns: Name, Max Vol, On Min, On Max, Page Vol, WHM, Bal, DB, DB Vol, and Trig. Below the table are two sections for 'Default Paging' and 'Group Paging', and a 'WH Page Type' section with a list of zones and checkboxes.

Name	Max Vol	On Min	On Max	Page Vol	WHM	Bal	DB	DB Vol	Trig
Living ...	100	0	100	75	X	0	X	75	Zone Ctrl
Bedroom	100	0	100	75	X	0	X	75	Zone Ctrl
Zone 3	100	0	100	75	X	0	X	75	Zone Ctrl
Zone 4	100	0	100	75	X	0	X	75	Zone Ctrl
Zone 5	100	0	100	75	X	0	X	75	Zone Ctrl
Zone 6	100	0	100	75	X	0	X	75	Zone Ctrl

Default Paging		Group Paging	
WH Page Type:	X	-	

Name	WH Page
Living Room	X
Bedroom	X
Zone 3	X

Quick Reference: S86A/P Zone Volume Settings	
Volume Control	
Max Vol	The Maximum volume allowed for a zone. Use this setting to prevent unpleasant volume levels or speaker damage in a zone.
On Min	The minimum volume level for a zone when it is turned on. If the zone is turned off with the volume below this point, it will return to this level when reactivated.
On Max	The maximum volume level for a zone when it is turned on. If the zone is turned off with the volume above this point, it will return to this level when reactivated.
Page Vol	The default volume for paging. Can be set from 0% (Off) to 100%. Default is 75%.
WHM	An "X" in this column designates that the zone participates in the Whole House Music functionality of the zone controller.
Bal	Adjust the default Left channel/Right channel balance for the zone output.
DB	An "X" in this column designates that the zone participates in the Doorbell functionality of the zone controller.
DB Vol	If DB is enabled in the previous column, set the default volume for doorbell. Can be set from 0% (Off) to 100%. Default is 75%.
Trig	<p>Programmable Trigger Outputs can be used to turn on/off power amplifiers or any device that requires a 12VDC 100mA signal for control. These outputs can be configured to:</p> <p>Zone Ctrl – Zone is on trigger is on. Zone is off trigger is off.</p> <p>Command – Only controlled when an On or Off command is received.</p>
Paging Preferences	
WH Page Type	<p>Default Paging. When Default Paging is selected, all zones on the M8 will switch to paging mode when a page is received. Default is On (X).</p> <p>Group Paging. If Group Paging is selected, zones can be grouped to respond to pages differently. Default is Off (-).</p>
Pg Group 1 – Pg Group 8	These columns display when Group Paging is selected as the WH Page Type. Eight paging groups are provided for paging customization. Each zone can be set to be a member of a group. By default, zones are only members of the WH (whole house) group.
WH Page	Select zones to participate in paging functionality. By default, all zones are selected for paging.

Note: Clicking the "Import Settings from Device" button will read in the current settings stored in the zone controller. If you are running g! Demo, do not click this button as there is no equipment connected.

- Right-click the **Living Room Max Vol** and set the value to 75 to prevent the living room zone from exceeding 75% volume. Note that when this setting is changed, the Max Vol Turn On setting changes to reflect the new Max Volume settings.

4. Right-click the **Living Room On Min** and set the value to 15. This tells the S86A/P to set the volume to at least 15% when the zone is activated.
5. Right-click the **Living Room On Max** and set the value to 25. This will ensure that when the zone is activated, the volume will be between 15 and 25%.
6. Set the values to 50, 10, and 15 for **Max Vol**, **On Min**, and **On Max** respectively for the Bedroom zone.

Zones

Name	Max Vol	On Min	On Max	Page Vol	WHM	Bal	DB	DB Vol	Trig
Living R...	75	15	25	75	X	0	X	75	Zone Ctrl
Bedroom	50	10	15	75	X	0	X	75	Zone Ctrl
Zone 3	100	0	100	75	X	0	X	75	Zone Ctrl
Zone 4	100	0	100	75	X	0	X	75	Zone Ctrl
Zone 5	100	0	100	75	X	0	X	75	Zone Ctrl
Zone 6	100	0	100	75	X	0	X	75	Zone Ctrl

Default Paging Group Paging

WH Page Type: X -

Name	WH Page
Living Room	X
Bedroom	X
Zone 3	X

7. Right-click the **Page Vol** for the Living Room zone and set it to 50. This will set the paging volume to 50%.
8. Right-click the **Page Vol** for the Bedroom zone and set it to 25.
9. Click the "X" in the WHM column for zones 3 through 6 (the X will turn to a -). This will prevent these unused zones from turning on when Whole House Music is selected.
10. Click the **Apply**. Since this lesson is not using an actual S86, click OK to close and ignore and warnings that may popup. When this is complete, your zone settings should look like the screen shown below.

Zones

Name	Max Vol	On Min	On Max	Page Vol	WHM	Bal	DB	DB Vol	Trig
Living R...	75	15	25	50	X	0	X	75	Zone Ctrl
Bedroom	50	10	15	25	X	0	X	75	Zone Ctrl
Zone 3	100	0	100	75	-	0	X	75	Zone Ctrl
Zone 4	100	0	100	75	-	0	X	75	Zone Ctrl
Zone 5	100	0	100	75	-	0	X	75	Zone Ctrl
Zone 6	100	0	100	75	-	0	X	75	Zone Ctrl

Default Paging Group Paging

WH Page Type: X -

Name	WH Page
Living Room	X
Bedroom	X
Zone 3	X

Exercise 9: Configure Zones in the Viewer

Overview At this point, you have added in a Zone Controller with a total of 6 zones. However, only two of those zones will actually be used—the Living Room and the Bedroom. The next step is to remove the unused zones from the Viewer so that the homeowner sees an uncluttered and intuitive interface.

How-to To remove the unused zones from the Viewer interface:

1. Select the **Interface** tab in the Configurator.
2. Under **Interface Devices (TouchScreen)** near the top of the System Tree, click the plus (+) sign to the left of the **Windows** option to expand the list.
3. Select **Tab Config: Media System**. *The list of available/visible zones for the media system display in the properties window on the right.*

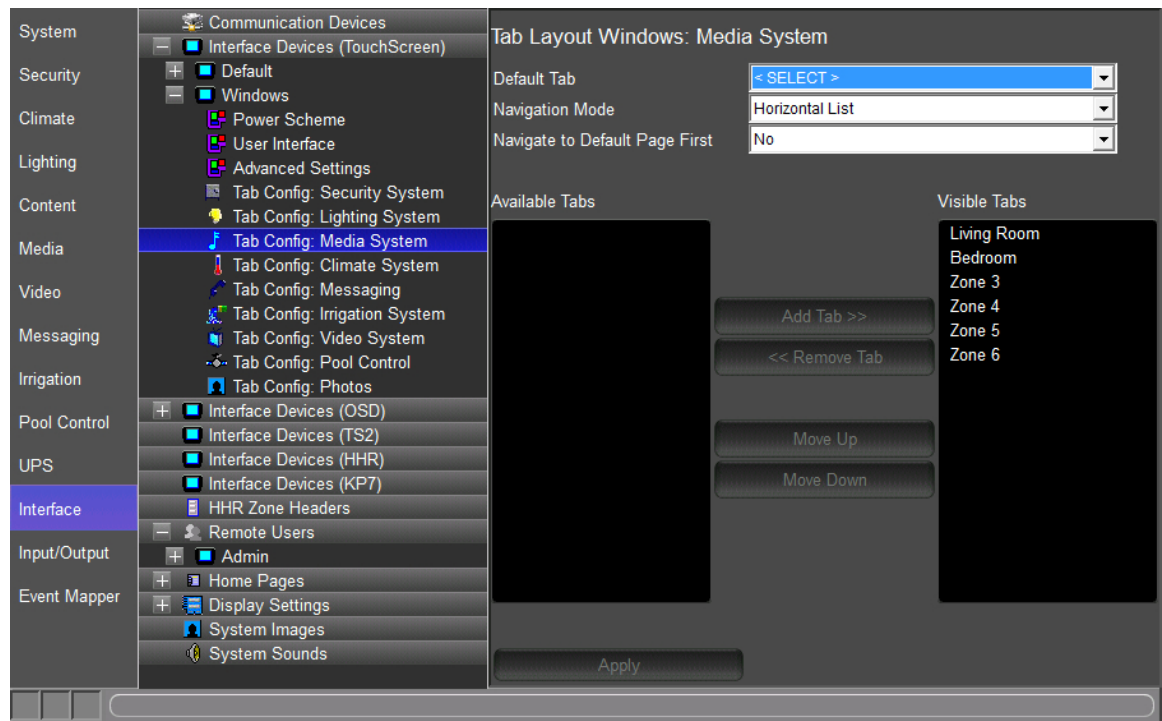

Visible Tabs= zones that appear in the Viewer for the homeowner to use.

Available Tabs= zones that are not currently displayed in the Viewer.

Since the Living Room and Bedroom zones are active in our Sample House, we need these zones to be in the **Visible Tabs** list. All of the remaining zones can be put in the Available tabs column hiding them from the viewer interface.

4. In the **Available Tabs** list, select **Zone 3**, then press and hold your keyboard shift button for multi-select and click **Zone 6** to select all zones to be removed from the selected viewer.
5. Click the **<< Remove Tab** button then click **Apply**. Your screen should look as below.

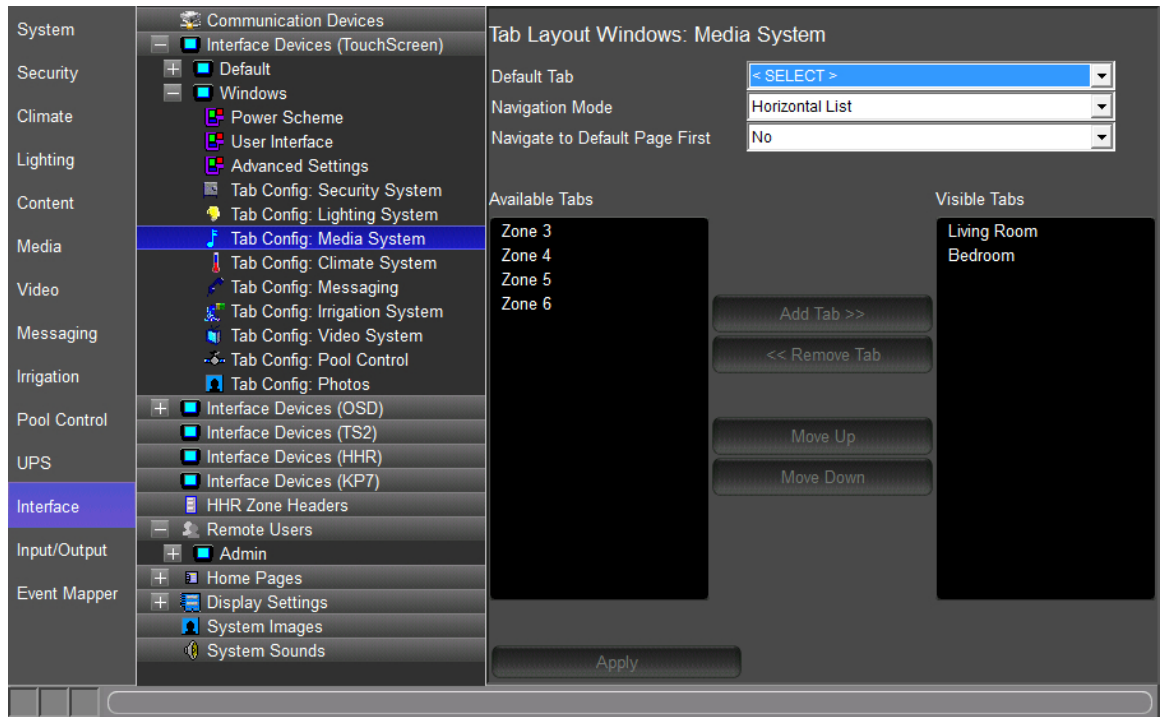

Notes about adding and removing tabs:

- 1) Working with tabs on the Interface tab in the Configurator only adds/removes the zone from the Viewer on a per-screen basis. The zone is not deleted and can be added back into the Viewer at any time if the homeowner would like to expand their system.
- 2) Multiple zones can be added or removed at one time. Press and hold the **CTRL** key on your keyboard and click to select the desired zones then click the Add Tab, or Remove Tab, button.
- 3) Each touch screen must be configured separately. In an actual system, each touch screen will have its own listing beneath the Default listing, and zones will need to be removed from each one individually. See the later lesson, *GUI and Interfaces* for more information.

Exercise 10: Check the Viewer

Overview In the previous lessons and exercises you used the Configurator to set up the ELAN Media system and interfaces. In this exercise you will finally check your configuration in the Viewer.

- How-to*
1. Click the Restore button in the upper-right corner of the Configurator window to exit Full Screen Mode. 
 2. On the **Media** tab, right-click the **Living Room** zone on the **S86A/P** and select **Show Virtual Zone**. *The Living Room Virtual Zone will be displayed.*
 3. From the g!Tools My Systems screen, click the **Viewer** button. The Viewer interface displays the **Home** page.
 4. Click the **g!** button in the upper right to access the main systems menu, then click **Media** to view the available media zones.

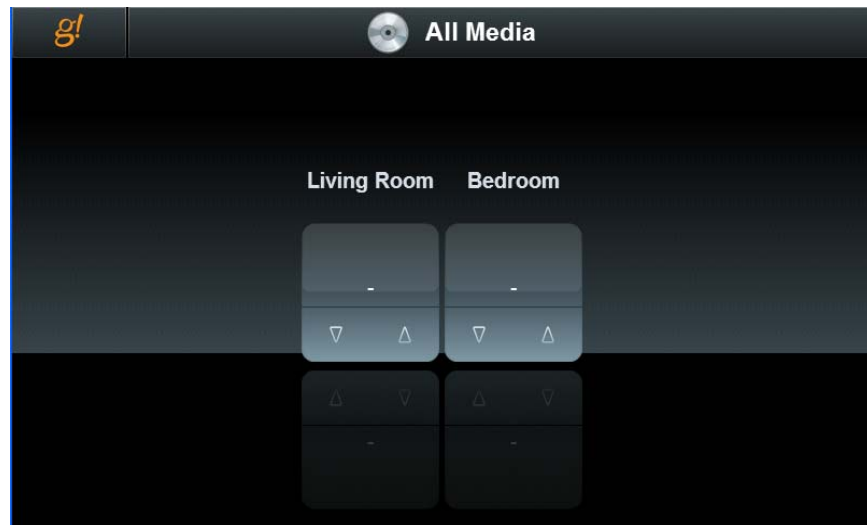

- Click the **Living Room** icon to view the Living Room user interface, click Source at the bottom of the screen to display the sources.



- Arrange the Viewer and the Virtual Zone on your desktop so that both are visible at the same time:



On this screen notice:

- The Sources are listed in the center of the Viewer.
- The Source Names and Icons match those selected in previous exercises.

- Click the **MP3 Player 1** source button. The built-in MP3 player interface displays.

Notice that the icon selected for the source indicates that this source is selected in this zone. Also note that the Living Room Virtual Zone switches to “On”.



- Click the **Source** button at the bottom, select the **AM/FM Tuner** source. The AM/FM Tuner interface displays, the Living Room Virtual Zone changes to “Source 2”, and the source indicator (icon and name) to the right of the Living Room heading changes.



9. Click the **Source** button at the bottom, select the **Sirius Tuner** source. *The Sirius Tuner interface displays, the Living Room Virtual Zone changes to “Source 4”, and the source indicator (icon and name) for the Living Room changes.*



10. Click the **Settings** button . *The settings interface opens, providing access to Bass, Treble, Loudness, Whole House Mode, and Do Not Disturb functionality.*



11. Click the **Settings** button again to return to the Living Room Theater page.

Lesson 7

Configuring Distributed A/V: Part 2



Overview

In this lesson you will build onto the distributed A/V system that you created in the previous lesson. You will first add a video source, then video displays, and finally configure a video switch to route video sources to the system.

You will:

- Learn the basic procedure for adding an IR controlled source (Note: Advanced IR topics will be covered in a later lesson).
- Learn how to add a source with a built-in two way driver and a customizable interface.
- Learn how Video Displays are configured in the system.
- Configure a video switch to route video for the two zones in our sample system.
- Configure the video switch to follow the audio (Zone Slaving).
- Add Video Displays to a zone and configure their power and input functions.
- Check the Viewer interface to confirm proper configuration.
- Understand the various features available in the Viewer.

Sample House

Our sample house is configured with two distributed A/V zones:

- Living Room
- Bedroom

Requirements

- A PC running g!Demo and g!Tools.
- or-
- g! system controller and g!Tools.

Distributed A/V Integration Overview

Overview The following diagram shows the equipment in a six source / two zone distributed A/V system schematically, illustrating the components that are important to the g! system controller.

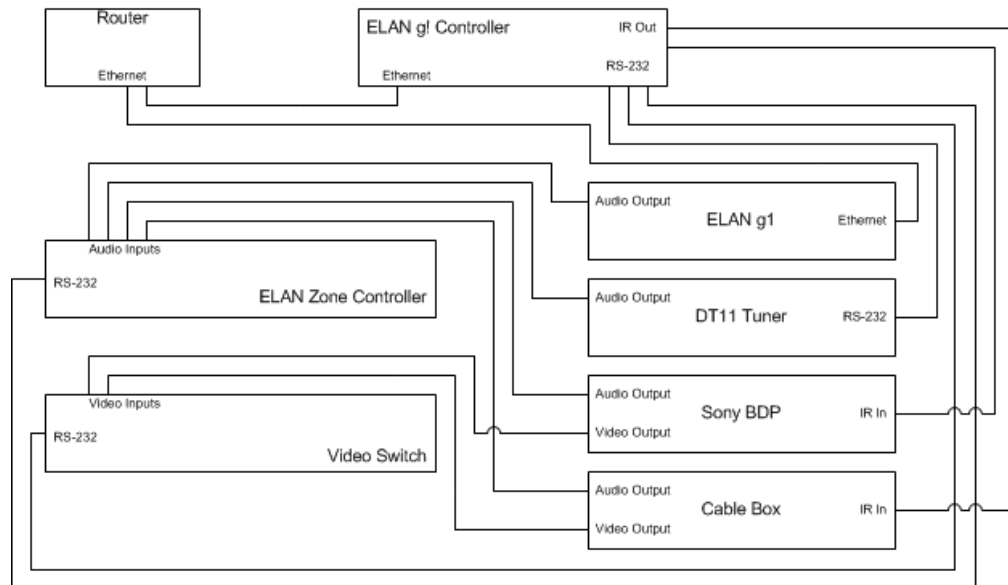

Integrating a distributed A/V system with ELAN provides the homeowner control of their audio system through the g! Viewer. For each A/V zone in their home, they can:

- Turn the zone on and off
- Select and control a source for the zone
- Adjust the audio volume in the zone
- Change the zone settings, such as bass and treble

Terms The following terms are used in the Configurator to describe the equipment in an A/V system:

- **Communication Device:** The method the g! software uses to communicate with an external device, including information about the connection type and protocol.
- **Audio Zone Controller:** The device used to distribute A/V throughout the home.
- **Keypads and Interfaces:** A custom defined interface for controlling A/V source components.

How-to Integrating a distributed A/V system with ELAN consists of the following steps:

- Add and configure **Sources**.
- Add the **Communication Device**
- Add the **Zone Controller** for the distributed audio
- Configure the **Audio Sources** and **Zones** in the audio zone controller.

Exercise 1: Add an IR Satellite TV Set Top Box

Overview

In Exercise 1, you will configure an IR-controlled satellite TV set top box. This source device is an example of the IR Device Library's pre-configured IR source templates. These pre-configured source devices may be used for quick and easy source programming.

The IR Device Library allows you to define the IR device parameters in order to add a pre-configured IR source to the g system. This feature does require the g controller be connected to a network with an active internet connection. Once the IR Device's parameters are defined the IR commands are automatically mapped to buttons and added in a source template. The source template may not be edited or changed. Adding an IR source using the IR Device Library is done in a few basic steps.

- Add New IR Library Source. This is the placeholder used to access the IR Library Source information.
- Import IR Library Source. Define the parameter of the IR source.
 - Name – Name used to reference the IR source in the configurator.
 - Manufacturer – Defines who makes the source device.
 - Type – Defines the type of source device, i.e. Set Top Box is the source type selected for cable TV, satellite TV, and other TV tuning boxes.
 - Device – Defines the IR codes used to control the device.

The result of this exercise is an interface configured for IR control that you add as a video source to the system in a later exercise.

Note: This lesson will only cover basic IR-controlled source configuration. See the advanced IR lesson for further information.

How-To 1. On the Configurator **Media** tab, right-click **Sources** in the System Node Tree, then select **Add New IR Library Source**. *The Import IR Library Source window opens.*

- a. Type **SAT TV** in the **Name** field.
- b. Select the **Manufacturer** drop down menu to choose **DirecTV**.
- c. Select the **Type** drop down menu to choose **Set Top Box**.
- d. Select the **Device** drop down menu to choose the correct IR code set. In this exercise choose **HIHR and Genie Series Satellite All Models Address 1**.

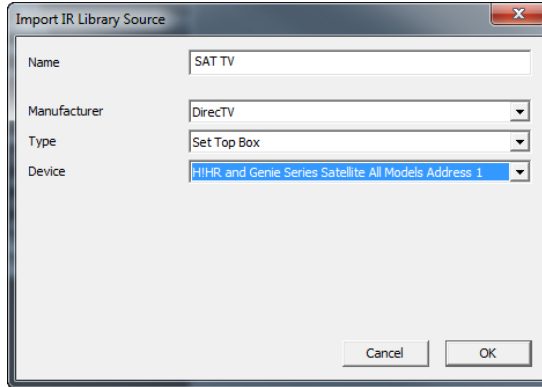

e. Click **OK** to add the new IR source interface.

2. Set the **IR Sender**.

- a. Select the **IR Sender** drop down menu and choose the desired IR Output. *This will define the IR output port that the IR signal is routed to on the g controller.*
- b. Select **Apply** when finished.

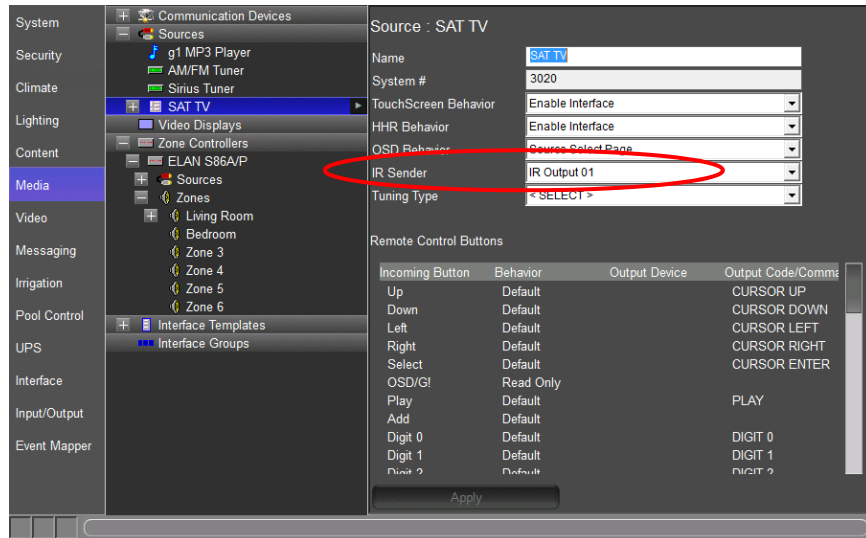

3. Set the **Tuning Type**.
 - a. Select the **Tuning Type** drop down menu and choose the desired Tuning Type. *This will allow a TV Channel icon press to send the channel number information entered in the TV Channels section of the Content tab to the source device.*
 - b. Select **Apply** when finished.

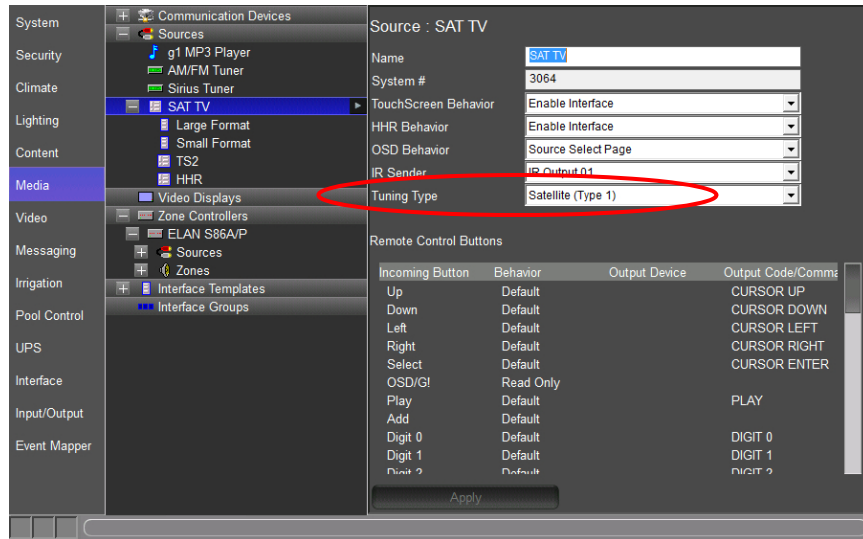

4. Check the interface layout in the configurator.
 - a. In the Sources node of the System Node Tree, select **SAT TV** and verify that the device settings are correct.

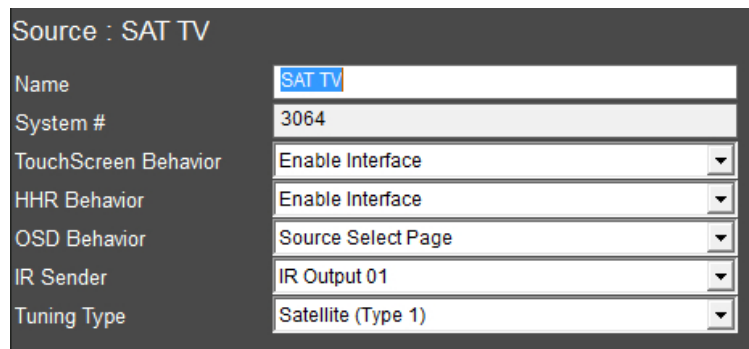

- b. Select Large Format, Large Landscape (Standard) resolution to view the pre-configured button layout.

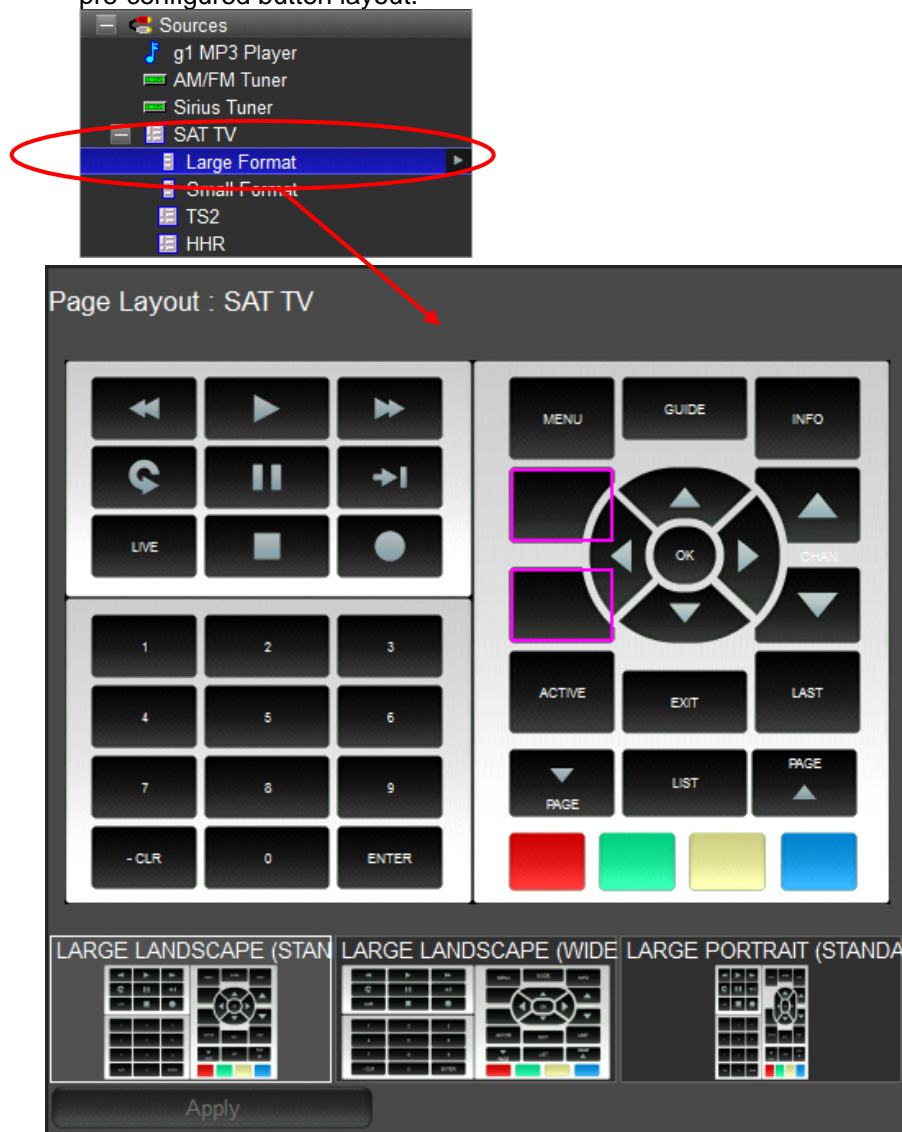

Note: The IR Library Source device is not customizable. For information on customizable IR sources please see Lesson 9, IR Control.

Exercise 2: Add the Video Source to the Zone Controller

Overview In this exercise, you will use the Configurator to assign and configure the video source added in the previous exercise to the S86A Zone Controller, added in the previous lesson. These steps will make the sources available in the Viewer.

How-To

1. In the **Media** tab System Tree, click the plus (+) sign next to **Sources** to expand the Source List for the ELAN S86A/P zone controller added in the previous lesson.

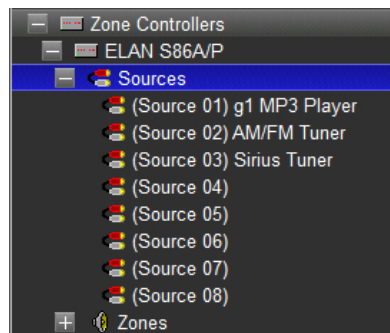

2. Select **Source 4**. *The Source Properties display on the right.*
 - a. From the **Source Device** drop-down, select **Interface: SAT TV**. *This selects the DirecTV interface as source 4 in the S86A.*
 - b. Click the **Select Icon** button then navigate to the **Media** folder and select an appropriate icon for the SAT TV. *This is the icon that will be displayed in the Viewer.*
 - c. Verify the **Display Name** is **SAT TV**. *This is the name that will be displayed in the Viewer.*
 - d. Click **Apply**.

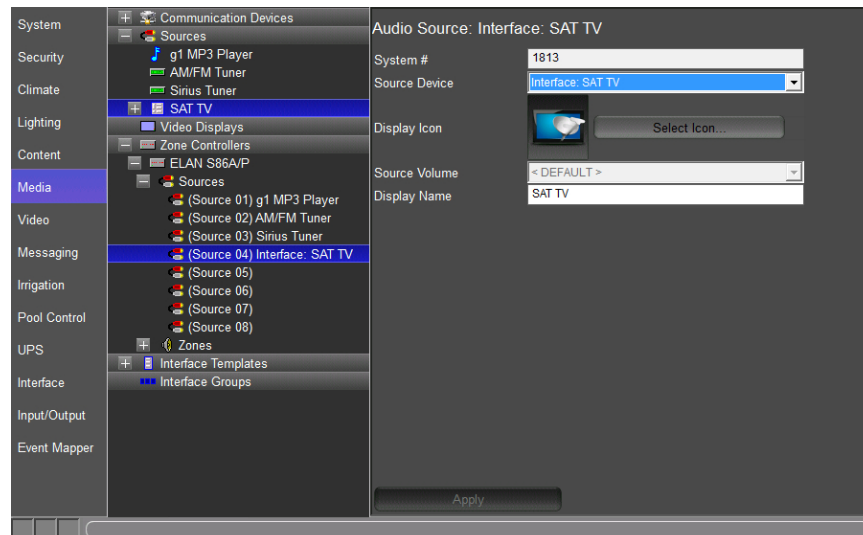

Exercise 3: Add IR Library Displays

Overview In Exercise 3, you will add two video displays with using the IR Library method shown in exercise 1. In a later lesson, you will configure the displays for a zone and define how they should react based on the source changes in the zone controller.

How-To

1. On the Configurator **Media** tab, right-click **Video Displays** in the System Node Tree, then select **Add New IR Library Display**. *The Import IR Library Display window opens.*
 - a. Type **Living Room LG TV** in the **Name** field.
 - b. Select the **Manufacturer** drop down menu to choose **LG**.
 - c. Select the **Device** drop down menu to choose the correct IR code set. In this exercise choose **Code Group 1**.

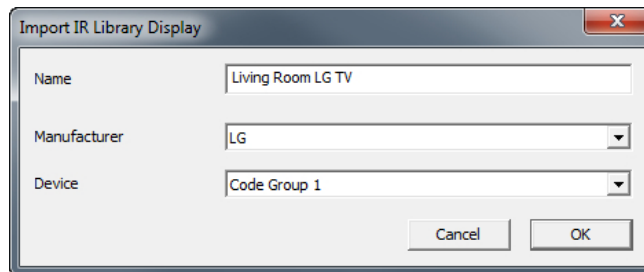

- d. Click **OK** to add the new IR controlled video display.
2. Set the **IR Sender**.
 - a. Select the **IR Sender** drop down menu and choose the desired IR Output. *This will define the IR output port that the IR signal is routed to on the g controller.*
 - b. Select **Apply** when finished.

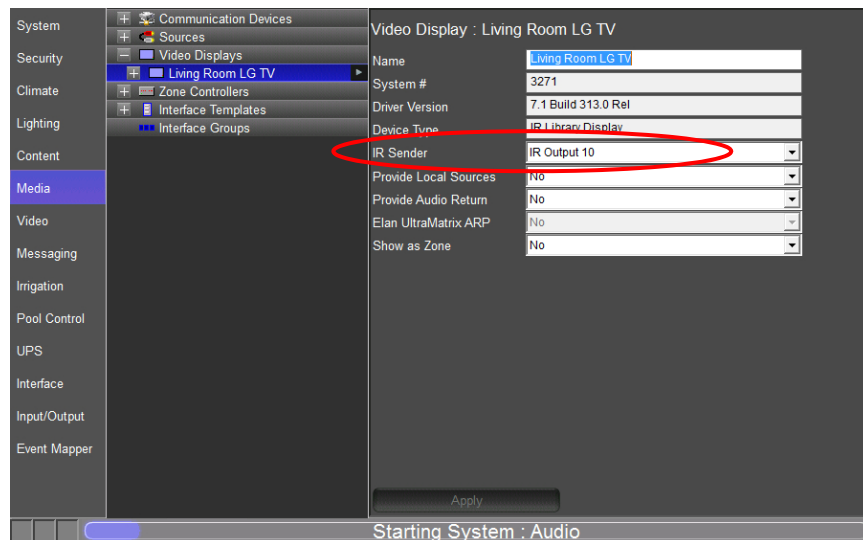

3. Set the **Show as Zone** option.
 - a. Select the **Show as Zone Type** drop down menu and choose **No**. *Setting this option to “Yes” will make the video display shown in the g!Viewer as a zone when the Media app is selected.*
 - b. Select **Apply** when finished.

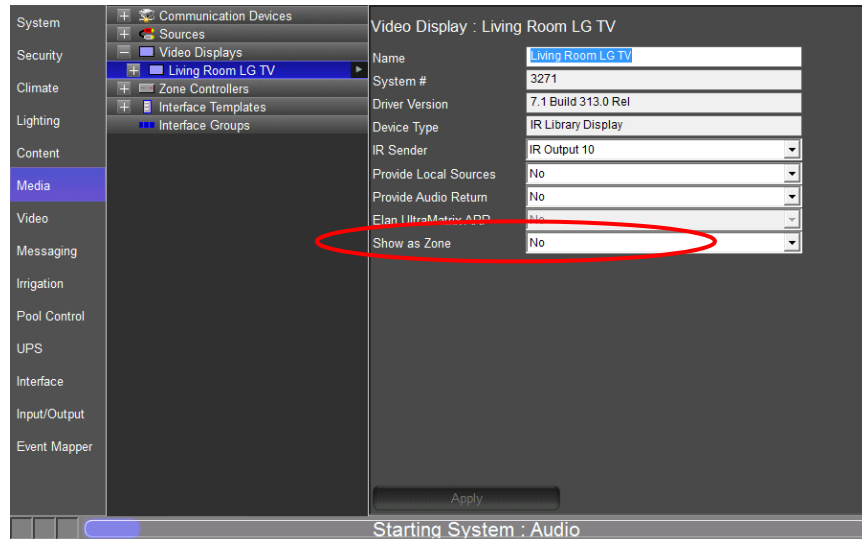

4. Repeat steps 1-3 above to add a second display. Name the second display “**Bedroom LG TV**.”
5. Your screen should now look like below.

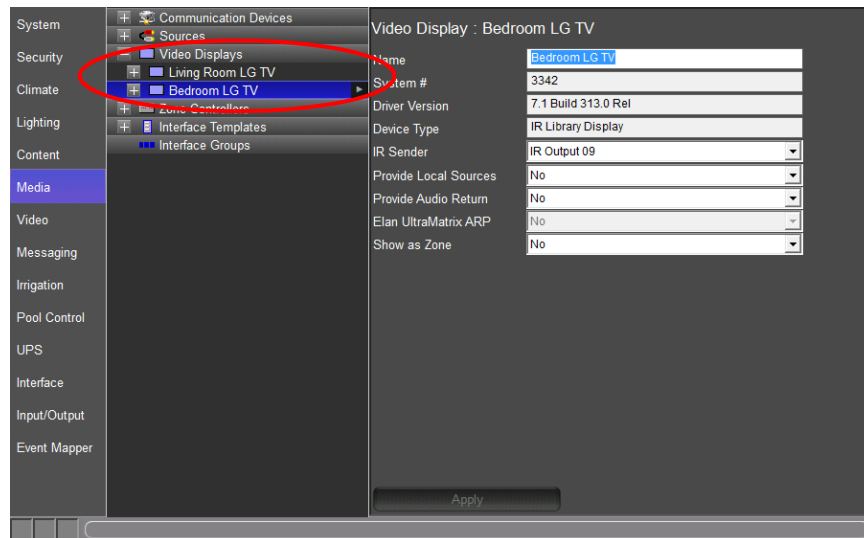

Exercise 4: Configure the Video Displays for the Zones

Overview In Exercise 4, you will use the Configurator to assign and configure the video displays added in the previous exercises. You will define the behavior for the displays in each zone on a source-by-source basis.

- How-to**
1. In the Configurator, go to the **Media** tab.
 2. Expand the zone list on the **S86A** and select the **Living Room** zone. *The Zone Properties will be displayed to the right.*
 3. From the **Display 1** drop-down menu, select **Living Room LG TV**. *The Living Room LG TV will be added as the display for this zone, and the Display On/Off and Display 1 Input columns will populate with the words "Don't Change":*

Source Display Name	From Zone	Show	Display On/Off	Display 1 Input	Volume Control
MP3 Player	LOCAL	Show	Don't Change	Don't Change	<< THIS ZONE >>
AM/FM Tuner	LOCAL	Show	Don't Change	Don't Change	<< THIS ZONE >>
Sirius Tuner	LOCAL	Show	Don't Change	Don't Change	<< THIS ZONE >>
SAT TV	LOCAL	Show	Don't Change	Don't Change	<< THIS ZONE >>

4. Configure the behavior of the display for each source listed in the **Source Display Name** column. In a typical system the display is shut off for audio only sources, and turned on for sources with a video feed.
 - a. The **MP3 Player** is an audio only source. In the **Display On/Off** column under Source Configuration, right-click **Don't Change** to pop up a menu with other options. Select **Turn Off** from the list.
 - b. Repeat step 4a for the other audio-only sources, to set the display to turn off when they are selected.
 - c. **Source 4 (SAT TV)** is an A/V source, so set the Display On/Off value to **Turn On**.

Source Display Name	From Zone	Show	Display On/Off	Display 1 Input	Volume Control
MP3 Player	LOCAL	Show	Turn Off	Don't Change	<< THIS ZONE >>
AM/FM Tuner	LOCAL	Show	Turn Off	Don't Change	<< THIS ZONE >>
Sirius Tuner	LOCAL	Show	Turn Off	Don't Change	<< THIS ZONE >>
SAT TV	LOCAL	Show	Turn On	Don't Change	<< THIS ZONE >>

d. Set the Display Input selection to the desired input being used.

Audio Zone: Living Room

Name: Living Room

System #: 1797

Universal Receiver: < NONE >

Display 1: Living Room LG TV

Display 2: < NONE >

Slave Zone 1: < NONE >

Slave Zone 2: < NONE >

Turn On Source: < NONE >

Hide Volume: No

Audio Return Input: < NONE >

Source Configuration					
Source Display Name	From Zone	Show	Display On/Off	Display 1 Input	Volume Control
MP3 Player	LOCAL	Show	Turn Off	Don't Change	<< THIS ZONE >>
AM/FM Tuner	LOCAL	Show	Turn Off	Don't Change	<< THIS ZONE >>
Sirius Tuner	LOCAL	Show	Turn Off	Don't Change	<< THIS ZONE >>
SAT TV	LOCAL	Show	Turn On	(INPUT HDMI 1)	<< THIS ZONE >>

e. Click **Apply**.

Note: In the following exercises you will add a video switch to the Configurator, so we assume here that all video sources will use the same input on their displays. If there is no video switch in your actual setup, you can change the input of the display in the **Display Input** column. Right-click the column and select a different input from the popup list.

5. Select the **Bedroom** zone on the S86A. Select **Bedroom LG TV** as the display for the bedroom, and then follow the steps above to assign the power & input states for each source:

Audio Zone: Bedroom

Name: Bedroom

System #: 1799

Universal Receiver: < NONE >

Display 1: Bedroom LG TV

Display 2: < NONE >

Slave Zone 1: < NONE >

Slave Zone 2: < NONE >

Turn On Source: < NONE >

Hide Volume: No

Audio Return Input: < NONE >

Source Configuration					
Source Display Name	From Zone	Show	Display On/Off	Display 1 Input	Volume Control
MP3 Player	LOCAL	Show	Turn Off	Don't Change	<< THIS ZONE >>
AM/FM Tuner	LOCAL	Show	Turn Off	Don't Change	<< THIS ZONE >>
Sirius Tuner	LOCAL	Show	Turn Off	Don't Change	<< THIS ZONE >>
SAT TV	LOCAL	Show	Turn On	(INPUT HDMI 1)	<< THIS ZONE >>

Exercise 5: Add the Video Switch and Configure Sources and Zones

Overview In Exercise 5, you will use the Configurator to add an Atlona AT-HD-V44M HDMI Video Switch to the system. The g! software considers any media switching device to be a Zone Controller, so the AT-HD-V44M is added as such. The Atlona AT-HD-V44M has a built-in two-way driver in the g! software.

Note: The g1 Controller is designed for use in smaller projects if 3rd party audio or video switching is needed than the gSC2 or gSC10 will need to be used.

- How-to*
1. In the Configurator, on the **Media** tab, right-click **Communication Devices** in the System Node Tree and select **Add New Communication Device**. The *Add New Communication Device* window opens.
 - a. Enter “Climate” as the **Device Name**
 - b. **Communication Type** select **Virtual HVAC Network**
 - c. **Hardware Type** select **Serial Port**
 - d. Select an **Unassigned** COM Port in the **COM Port** drop down (See Note)

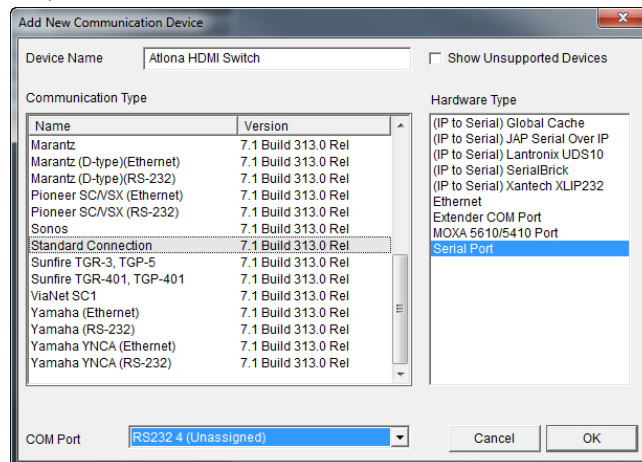

Note: The drop-down menu only shows the ports that are available on the g controller being used.

Quick Reference: Add New Communication Device	
Device Name	Enter a name for the external device. This can be any name, but should be descriptive so that you can identify this specific device in the Configurator. DO NOT leave this field set to "New Device".
Show unsupported devices	Select this checkbox to display legacy devices in the Communication Type window. Legacy devices have not been tested with the current version of g! and are no longer supported by ELAN. If you choose to install an unsupported device, a message will display to warn that the device is not supported by ELAN technical support.
Communication Type	This is the protocol of the communication. See the <i>Integration Note</i> for the specific thermostat for more information.
Hardware Type	The type of connection you are using, such as serial port or Ethernet.
Device	This drop down will populate with the appropriate device for the selected Hardware Type. I.E. When Serial Port Hardware Type is selected the Device dropdown changes to COM Port.

- Right-click **Zone Controllers** in the System Node Tree and select **Add New Zone Controller**. *The Add New Zone Controller window opens.*

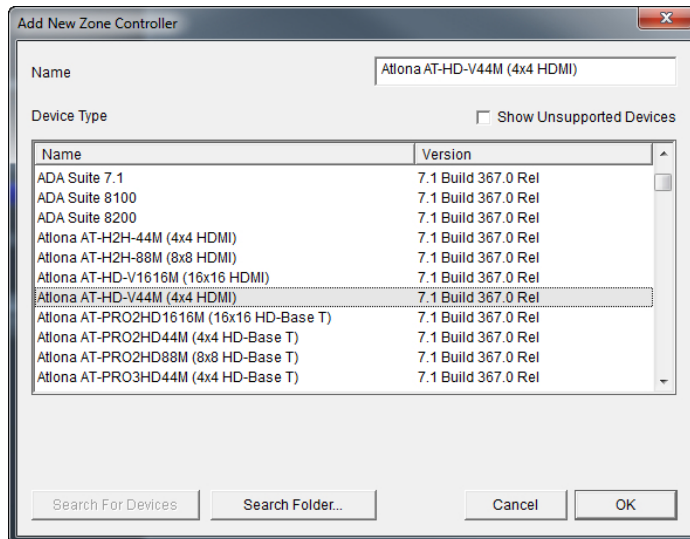

3. Select **Atlona AT-HD-V44M (4x4 HDMI)** as the **Device Type**, then click **OK**.
The Atlona Video Switch is added to the Configurator.

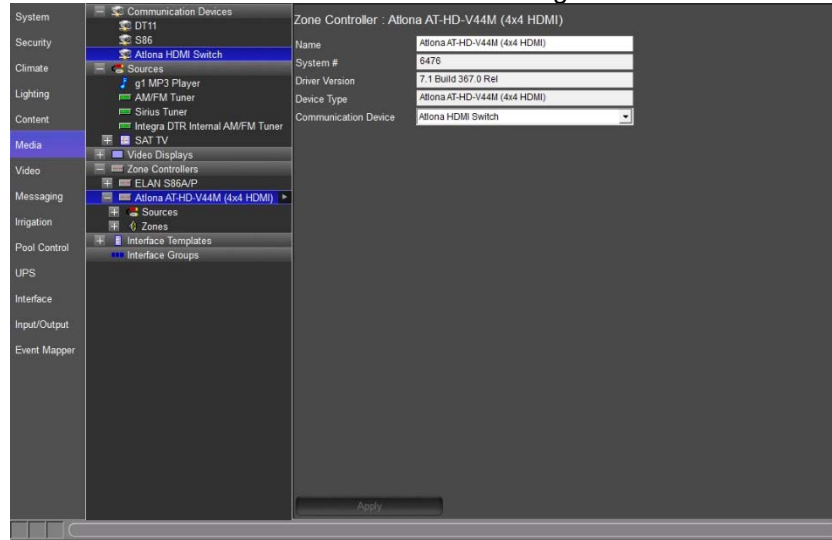

4. Expand the list of sources on the AT-HD-V44M .
 - a. From the **Source Device** drop-down list, select **Interface: SAT TV** as the source device for (Source 1).

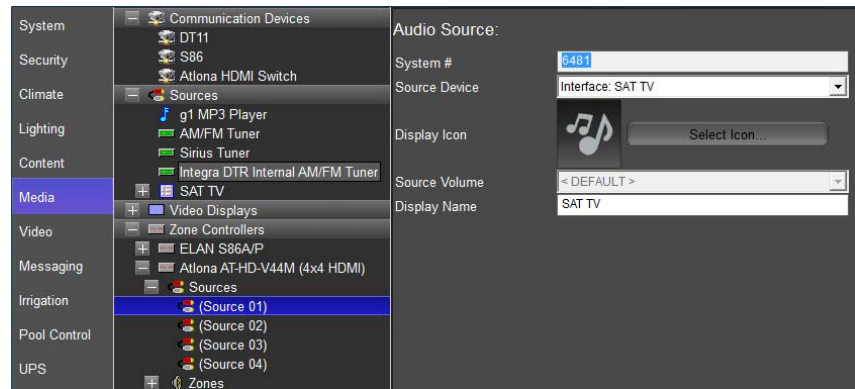

- b. Select the **Select Icon** button. *The Select Icon window will open.*
 - i. Click the plus (+) sign next to the Icons folder, then select the **Media** subfolder. Use one of the icons that display in the window, or navigate to the Color or Gray folders to see more options. Select the icon you wish to use for the source and click **OK**.

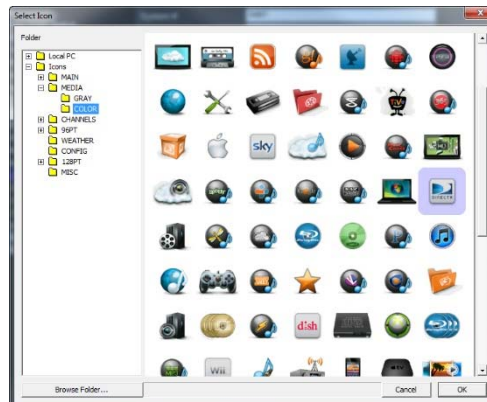

- c. Check the **Display Name** entry. The name should be user friendly, like “SAT TV”. *The Display Name is what will appear in the Viewer.*

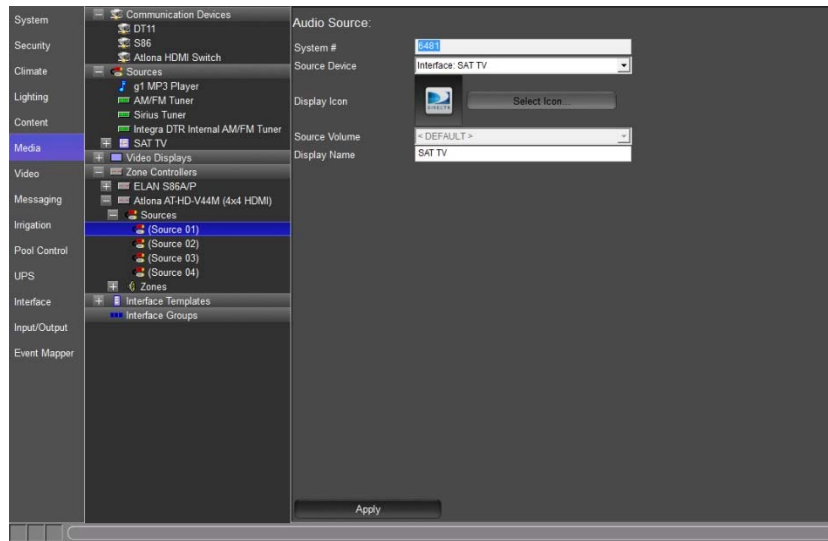

- d. Select **Apply** when finished.
5. Expand the **Zones** list for the AT-HD-V44M .
- a. Select **Output 1** and name it “**Living Room TV**”, and click **Apply**.
 - b. Select **Output 2** and name it “**Bedroom TV**”, and click **Apply**.

Note: ELAN recommends that you rename all video zones with descriptive names to make them easier to identify and differentiate between the audio zones.

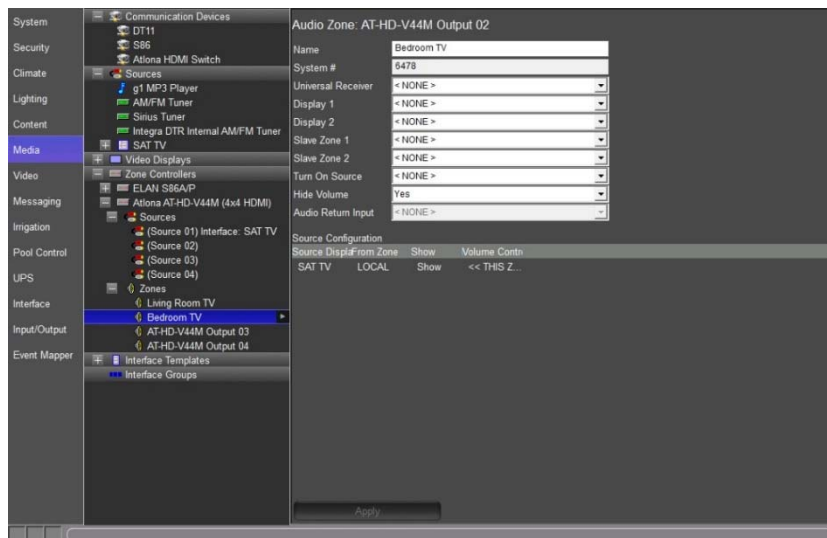

Exercise 6: Configure the Video Switch to Follow Audio Zones (Slaving)

Overview The gl! software uses the concept of *slave zones* to sync the video sources from the video switch with the audio sources from the audio zone controller without needing to write complex macros.

A slave zone is assigned to an audio zone via a drop-down list in the master zone's properties. Then, in the Zone's Source Configuration Matrix, you can specify the source to which the slave zone should change when a particular audio source is selected. This allows you to hide the video switch's zone by removing it from the Viewer, and yet maintain full switching functionality.

Note: Although it is possible to slave any zone in the system to any other, typical configurations will have the audio zone act as the “master” and the video zone as the “slave.” Controlling the audio zone automatically selects the appropriate video source, and also provides volume control.

- How-to*
1. In the Configurator, go to the **Media** tab.
 - a. From the **Zone** list on the **S86A**, select the **Living Room** zone.
 - b. Select **Atlona AT-HD-V44M Zone 1 (Living Room Video)** from the **Slave Zone 1** drop-down in the properties window. *The Slave 1 Source column in Source Configuration populates with the words “Don't Change” for each of the available sources:*

Audio Zone: Living Room

Name	Living Room
System #	1797
Universal Receiver	< NONE >
Display 1	Living Room LG TV
Display 2	< NONE >
Slave Zone 1	Atlona AT-HD-V44M (4x4 HDMI) Zone 1 (Living R
Slave Zone 2	< NONE >
Turn On Source	< NONE >
Hide Volume	No
Audio Return Input	< NONE >

Source Configuration							
Source	Display Name	From Zone	Show	Display On/Off	Display 1 Input	Slave 1 Source	Volume Control
MP3 Player	LOCAL		Show	Turn Off	Don't Change	Don't Change	<< THIS ZONE >>
AM/FM Tuner	LOCAL		Show	Turn Off	Don't Change	Don't Change	<< THIS ZONE >>
Sirius Tuner	LOCAL		Show	Turn Off	Don't Change	Don't Change	<< THIS ZONE >>
SAT TV	LOCAL		Show	Turn On	(INPUT HDMI 1)	Don't Change	<< THIS ZONE >>

2. Next, configure the behavior of the Atlona AT-HD-V44M for each source listed in the Source Display **Name** column.
 - a. The MP3 Player is an audio only sources. In the **Slave 1 Source** column, under Source Configuration, leave these selections set to **Don't Change**.
 - b. Do the same for the other two audio only sources, the two feeds from the ELAN DT11 Tuner.
 - c. **Source 4 (SAT TV)** is an A/V source. For these, right-click **Don't Change** in the **Slave 1 Source** column to popup the list of sources on the AT-HD-V44M. Select the appropriate source from the list.

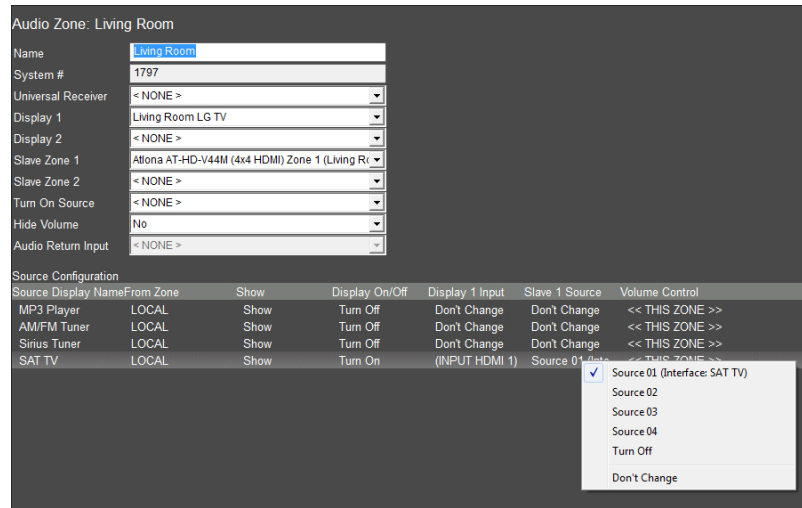

3. Repeat step 2 for the **Bedroom** zone.

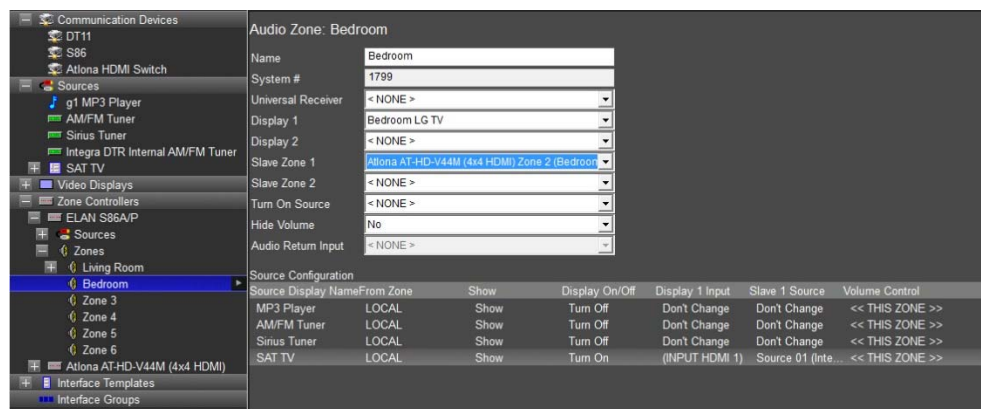

Exercise 7: Configure Zones in the Viewer

Overview In the previous exercises, you added an Atlona At-HD-V44M Video Zone Controller with a total of four zones. However, none of the video zones' interfaces are required in the Viewer. The next step is to remove these unused zones from the Viewer interface to present a clean interface and reduce confusion for the homeowner.

How-to To remove the unused zones from the Viewer interface:

1. Select the **Interface** tab in the Configurator.
2. Under **Interface Devices (TouchScreen)** near the top of the System Node Tree, click the plus (+) sign to the left of the **Windows** option to expand the list.
3. Select **Tab Config: Media System**. The list of available/visible zones for the media system display in the properties window on the right.

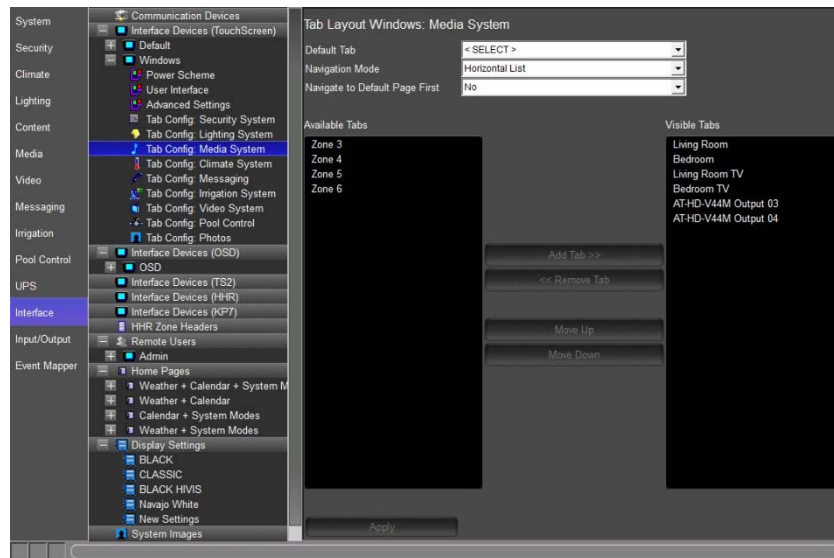

Visible Tabs = zones that appear in the Viewer for the homeowner to use.

Available Tabs = zones that are not currently displayed in the Viewer.

Since the **Living Room** and **Bedroom** zones are active in our Sample House, we need these zones to be in the **Visible Tabs** list. All of the remaining zones including the video outputs can be put in the Available tabs column, hiding them from the Viewer interface.

4. In the **Visible Tabs** list, select all zones except for **Living Room** and **Bedroom**, click the **<<Remove Tab** buttons, and then click **Apply**. Your screen should look as below.

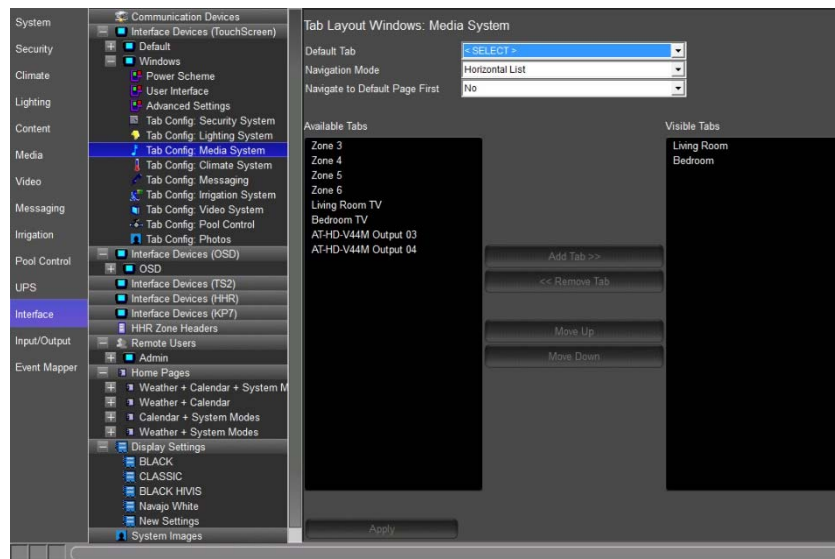

Notes about adding and removing tabs:

- 1) Working with tabs on the Interface tab in the Configurator only adds/removes the zone from the Viewer on a per-screen basis. The zone is not deleted and can be added back into the Viewer at any time if the homeowner would like to expand their system.
- 2) Multiple zones can be added or removed at one time. Press and hold the keyboard **CTRL** key and click to individually select the desired zones, then click the Add Tab>> or <<Remove Tab button. Press and hold the keyboard **SHIFT** button to multi-select all zones to be removed.
- 3) Each touch screen must be configured separately. In an actual system, each touch screen will have its own listing beneath the Default listing, and zones will need to be removed from each one individually. See the lesson on *GUI and Interfaces* for more information.

Exercise 8: Check the Viewer

Overview In the previous lessons and exercises you used the Configurator to set up the ELAN Media system and interfaces. In this exercise you will finally check your configuration in the Viewer.

How-to

1. Click the Restore button in the upper-right corner of the Configurator window to exit Full Screen Mode. 
2. On the **Media** tab, right-click the **Living Room** zone on the **S86A** and select **Show Virtual Zone**. *The Living Room Virtual Zone will be displayed.*
3. Right-click the **Living Room TV** display and select **Show Virtual Display**. *The Living Room Virtual Display will be shown.*
4. Start the Viewer from the g!Tools My Systems screen. The Viewer interface displays the **Main Menu** page.
5. Click **Media** to view the available media zones.

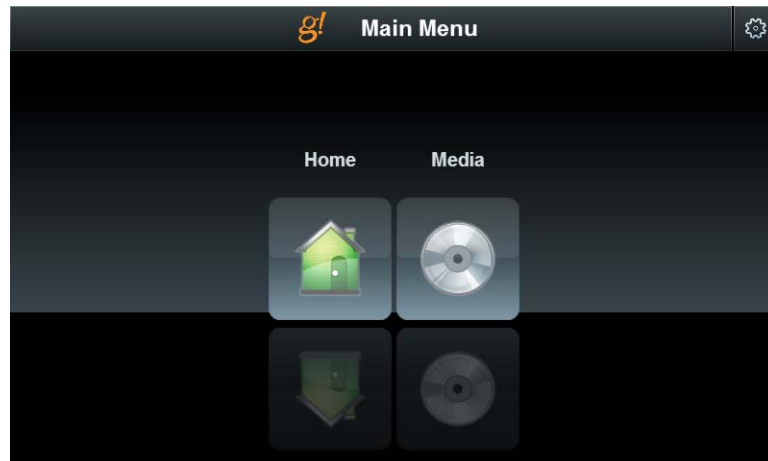

6. Click the **Living Room** icon and then click the **Source** button at the bottom of the screen.



7. Arrange the Viewer and the Virtual Displays on your desktop so that all are visible at the same time:



On this screen notice:

- The Source Names and Icons match those selected in the training exercises.
 - The Living Room Virtual Zone shows that the zone is off
 - The Living Room TV Virtual Display shows that the display is off.
8. Click the **MP3 Player** source button in the Viewer interface. The built-in MP3 player interface displays.

Notice that the icon selected for the source indicates that this source is selected in this zone. Also note that the Living Room Virtual Zone switches to “On”, but since this is an audio only source, the Television zone does not change.



9. Click the **Source** button on the bottom and select the **SAT TV** source. Notice:
- *The SAT TV interface displays,*
 - *Living Room TV Virtual Display changes to “On”,*
 - *Living Room Virtual Display changes to “INPUT HDMI 1”,*
 - *Living Room Virtual Zone changes to “Source 4”,*
 - *Source indicator (icon and name) to the right of the Living Room heading changes.*



Lesson 8

Configuring Home Theater Systems



Overview

This lesson shows you how to set up a basic Home Theater receiver.

You will:

- Learn how a home theater system is organized in the Configurator.
- Configure a receiver for the home theater.
- Add the internal tuner as a source.
- Configure sources for the home theater receiver, including the pre-out from another zone controller.
- Add the Video Display to the home theater and configure its behavior.
- Check the Viewer interface to confirm proper configuration.
- Understand the various features available in the Viewer.

Sample House

Our sample house will be configured with one home theater zone that includes 1 AVR, 1 Video Display, and three sources.

Requirements for this lesson

- g! system controller and g!Tools.

Home Theater Integration Overview

Overview The following diagram shows the equipment in a home theater system schematically, illustrating the components that are important to the g! system controller.

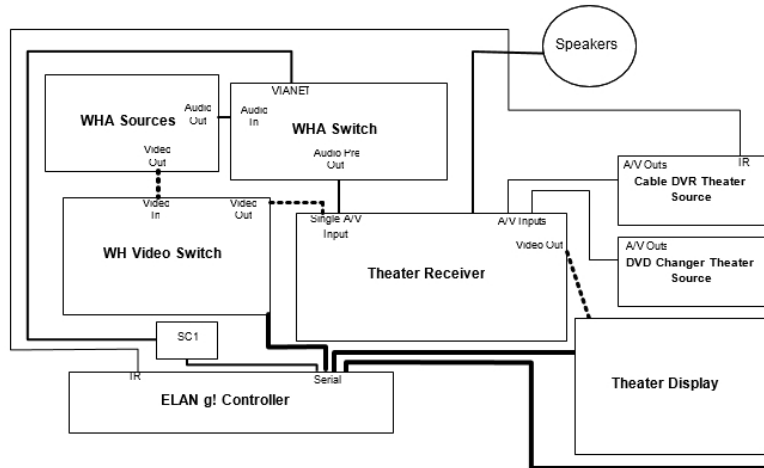

Integrating a home theater system with the g! Software provides the homeowner with control of their home theater system through the g! Viewer, they can:

- Turn the zone on and off
- Select and control a source for the zone
- Adjust the audio volume in the zone
- Change the zone settings, such as bass and treble
- Change the listening modes on supported receivers

Terms The following terms are used in the **Configurator** to describe the equipment in a home theater system:

- **Communication Device:** The method the g! software will use to communicate with an external device, including information about the connection type and protocol.
- **Audio Zone Controller:** The surround sound receiver
- **One-Way Device:** A custom interface for controlling A/V components.

How-to This lesson consists of the following steps:

- Add and Configure **Sources**.
- Add the **Communication Device**.
- Add the **Zone Controller**.
- Add the video **Displays**.
- Configure the **Sources** and **Zones** in the Zone Controller.
- Configure a WHA zone output as a Source on the Receiver.
- Check for proper operation in the g! Viewer.

Exercise 1: Add an IR Device and Import Codes from the Common Resource Library

Overview The g! Software includes the IR Device Library, an IR source database that allows for importing pre-created IR sources directly into the software. The IR Device Library allows you to define the IR device parameters in order to add the desired pre-configured IR source to the g system.

Note: The IR Device Library does require an active internet connection before first use. Source templates and IR codes assigned to the source templates may not be edited or changed.

In Exercise 1, you will create a new IR device for a DirecTV Box and a Samsung Blu-Ray Disc Player.

How-to The IR Device will include all the details for the device being controlled, including settings such as the emitter port on a Global Cache, repeat counts, toggle bits (if needed), and the IR Codes themselves.

1. On the Configurator **Media** tab, right-click **Sources** in the System Node Tree, then select **Add New IR Library Source**. *The Import IR Library Source window opens.*
 - a. Type **SAT Theater TV** in the **Name** field.
 - b. Select the **Manufacturer** drop down menu to choose **DirectTV**.
 - c. Select the **Type** drop down menu to choose **Set Top Box**.
 - d. Select the **Device** drop down menu to choose the correct IR code set. In this exercise choose **H!HR and Genie Series Satellite All Models Address 1**.

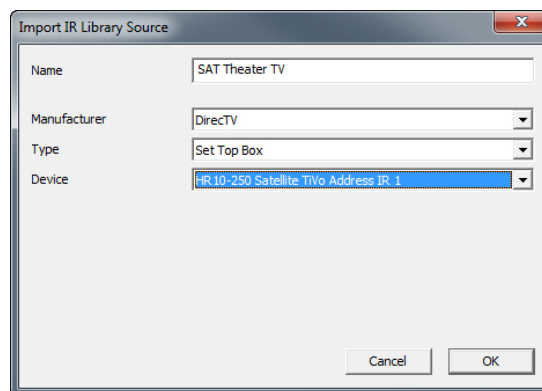

- e. Click **OK** to add the new IR source interface.

2. Set the **IR Sender**.

- a. Select the **IR Sender** drop down menu and choose the desired IR Output. *This will define the IR output port that the IR signal is routed to on the g controller.*
- b. Select **Apply** when finished

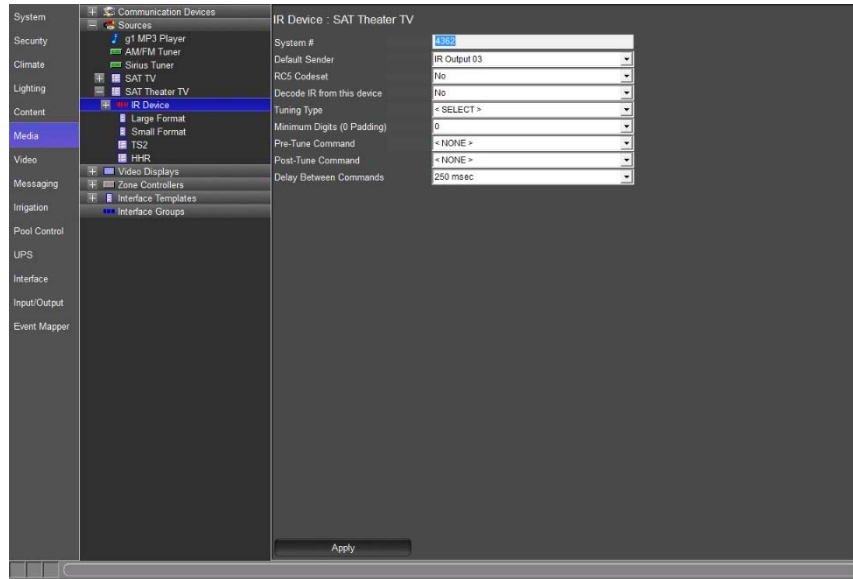

3. Set the **Tuning Type**.

- a. Select the **Tuning Type** drop down menu and choose the desired Tuning Type. *This will allow a TV Channel icon press to send the channel number information entered in the TV Channels section of the Content tab to the source device.*
- b. Select **Apply** when finished.

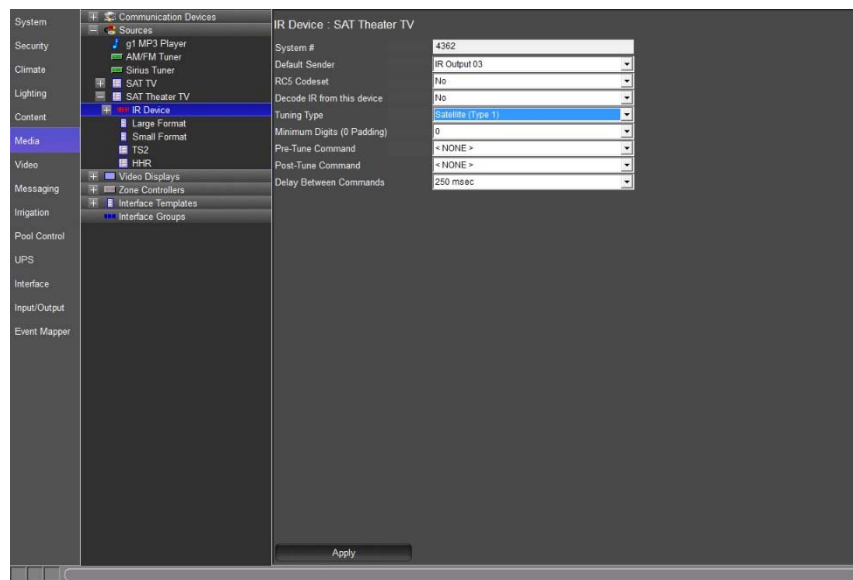

4. Check the interface layout in the configurator.
 - a. In the Sources node of the System Node Tree, select **SAT Theater TV** and verify that the device settings are correct.

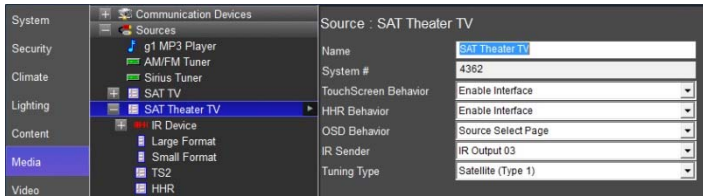

- b. Select Large Format, Large Landscape (Wide) resolution to view the pre-configured button layout.

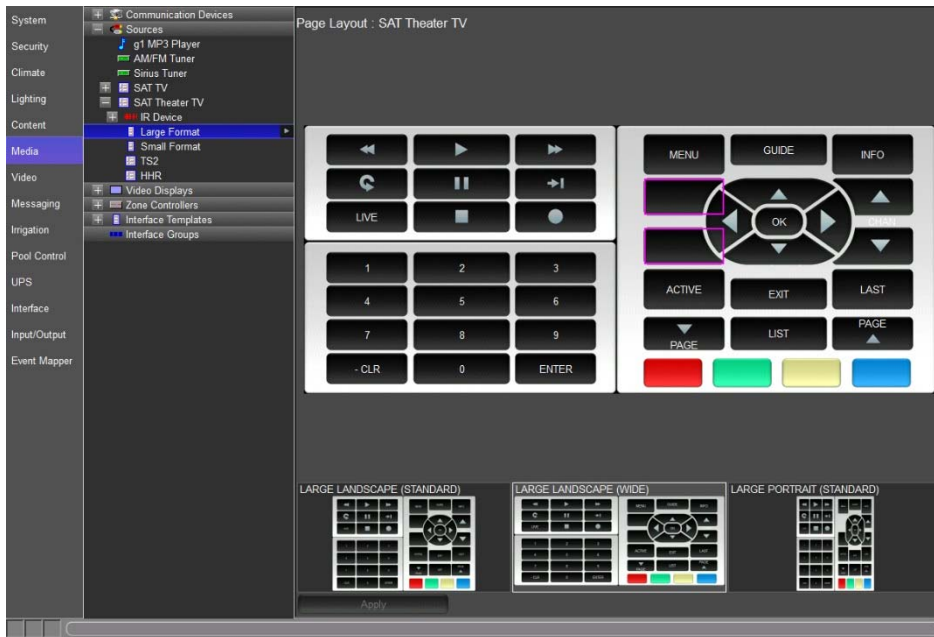

5. Repeat steps 1 thru 4 to add a Samsung Blu-Ray Disc Player. Use the below settings when adding the unit. When finished your screen should look similar to the below image.
 - a. Name: BDP
 - b. Manufacturer: Samsung
 - c. Type: Blu Ray
 - d. Device: All Models

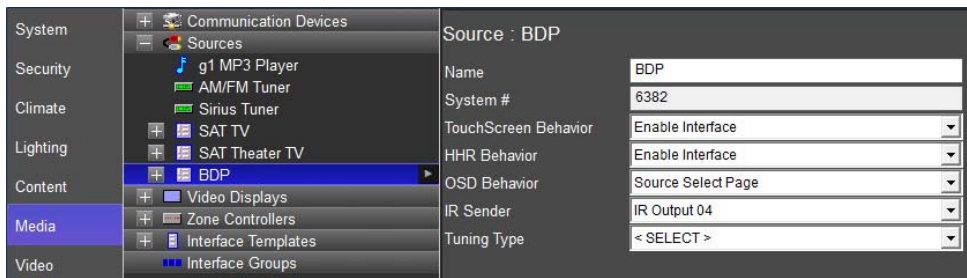

Exercise 2: Add a Communication Device and A/V Receiver

Overview

In the following steps you will add a communication device to communicate with the home theater system, an Integra DTR-60.5 in our example. The communication device is the bridge between the g! software and the receiver, and is where you will specify how the systems are physically connected and what communication protocol should be used.

In a typical installation, the receiver is the heart of the home theater system. Note that the g! software considers the receiver to be an Audio Zone Controller, and so that is how you will add it to the Configurator.

Note: Actual system setup may be different depending upon which receiver is installed on site. Refer to the *Integration Notes* for the particular receiver for details.

How-to

1. Start the **Configurator** and click the **Media** tab on the left.
2. Right-click **Communication Device** and select **Add New Communication Device**. In the dialog box:
 - a. Enter “Integra AVR” as the Device Name.
 - b. **Communication Type** select **Integra RI System (RS-232)**.
 - c. **Hardware Type** select **Serial Port**.
 - d. Select an **Unassigned COM Port** in the **COM Port** drop-down box
 - e. Click **OK**.

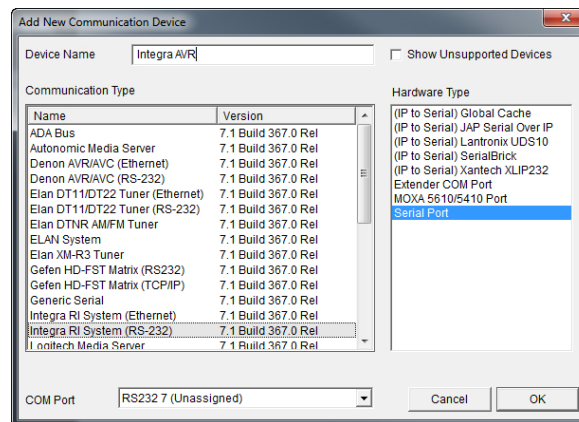

Note: The drop-down menu shows a list of all COM ports and indicates if a port is in use. Leave the selection set to **NONE** if you are using **g!Demo**.

- Verify settings in the **Properties Pane** for the newly added Integra **Communication Device**.

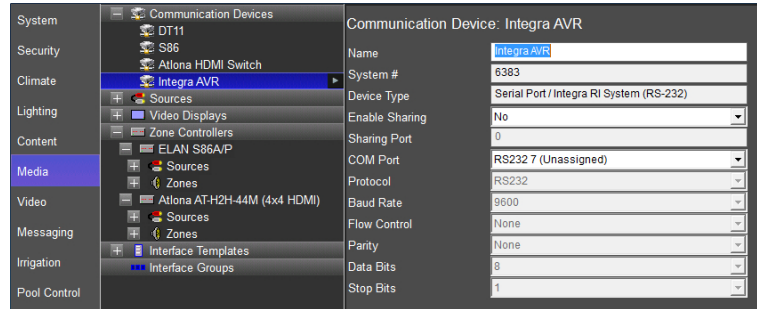

In the steps below, you will add the Integra DTR-60.5 to the Configurator.

- In the Configurator on the **Media** tab, right-click **Zone Controllers**, then click **Add New Zone Controller**. *The Add New Zone Controller dialog box opens.*
- Select **Integra DTR-60.5** as shown below, and then click **OK**.

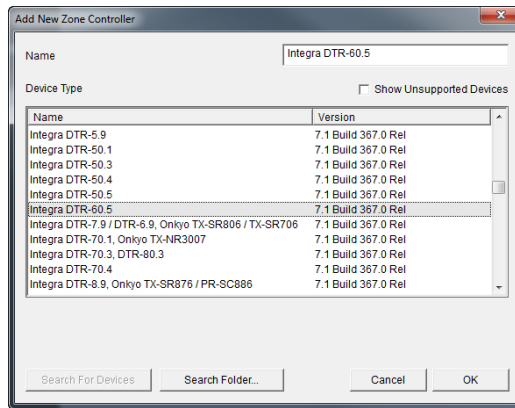

- Verify the setting for the newly added Integra DTR-60.5. The Integra Communication Device (added in steps 1-3 of this exercise) should automatically be selected for the Zone Controller.

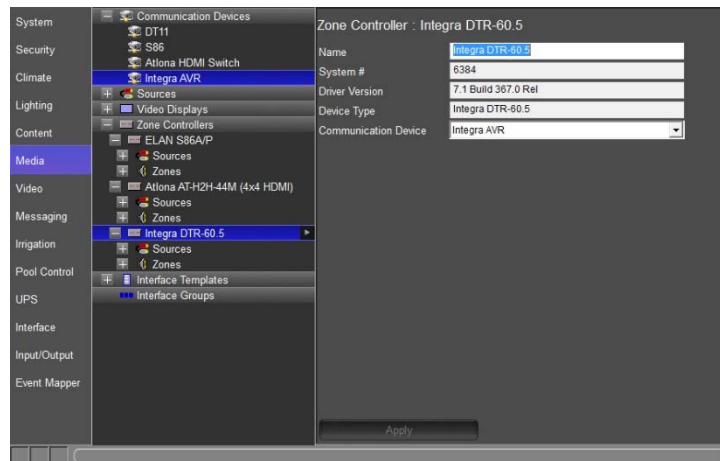

Exercise 3: Add the Integra Receiver's Internal Tuner Source

Overview In Exercise 3, you will add the Integra DTR-60.5's internal tuner to the Configurator.

Many surround sound receivers have AM/FM tuners built in. The g! software can control those tuners using our built-in AM/FM tuner interface; simply add the tuner and connect it as a source to the zone controller. Because the tuner is a part of the receiver, you do not need a separate communication device, it will share the Sunfire communication device. Be sure you have completed Exercise 2 before beginning this exercise.

- How-to*
1. On the **Media** tab, right click the **Sources** node, and select **Add New Tuner**. *The Add New Tuner dialog box opens.*
 2. Scroll through the list and select **Integra DTR Internal AM/FM Tuner**, then click **OK**.

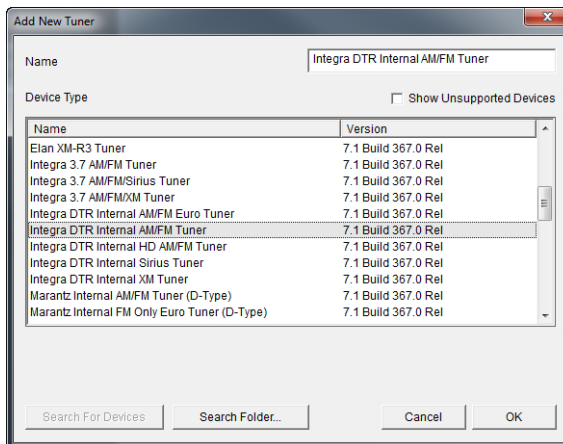

3. Check the settings for the tuner in the properties window. The Communication Device should be automatically set to Integra AVR.

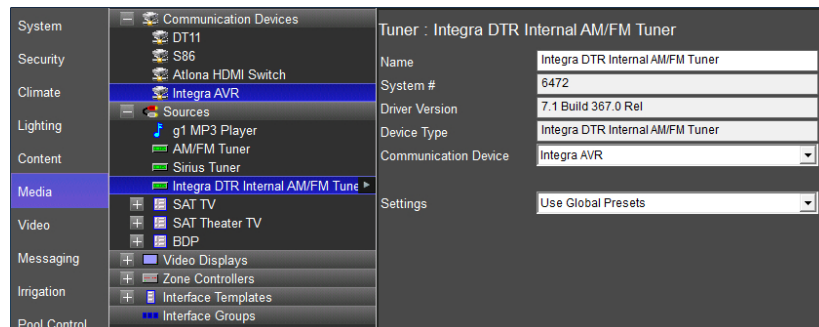

Note: The Integra AVR Communication Device added in exercise 2 is highlighted, indicating that the tuner was automatically associated with that Communication Device.

Exercise 4: Configure Sources

Overview Before beginning Exercise 4, be sure that you have added sources, the Receiver and Internal Tuner. In this exercise you will associate the sources with the appropriate inputs on the receiver.

In a typical installation, sources are assigned to specific inputs on the receiver. The g! software needs to know which sources are assigned to each input so that the correct signals can be sent to the receiver based on user input in the Viewer interface. This procedure is the same for most supported receivers.

For our Sample House, you will configure the sources added in previous exercises, SAT Theater TV, BDP, and Integra DTR AM/FM Tuner.

How-to

1. In the Configurator on the **Media** tab, Zone Controllers node, click the plus sign (+) to expand the Source List for the **Integra DTR-60.5** receiver.

Note: The names shown for sources should match the input names printed on the back of the receiver.

2. Select **(CBL/SAT)** from the list of available sources. The properties for (CBL/SAT) will be displayed in the window on the right.
3. From the **Source Device** drop-down list, select **Interface: SAT Theater TV** as the source device for (CBL/SAT), then click **Apply**. *The (CBL/SAT) entry in the System Node Tree changes to reflect its association with the SAT Theater TV Interface. The interface itself is also highlighted to indicate that it is the device referenced by the source.*

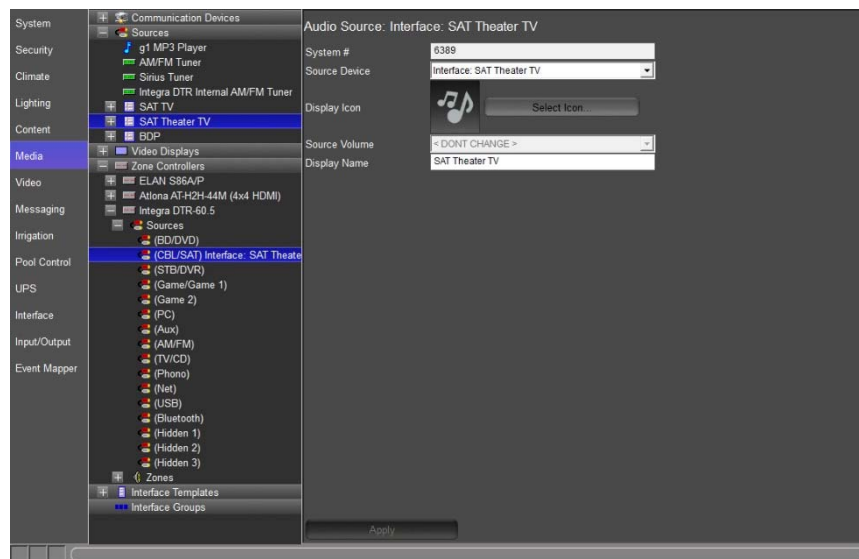

Note: To ensure proper control, the source devices must be connected to the same physical input as is specified in the Configurator.

4. In the properties window, click the **Select Icon** button. *The Select Icon window will open.*
 - a. Click the plus (+) sign next to the Icons folder, then select the **Media** subfolder. Use one of the icons that display in the window, or navigate to the Color or Gray folders to see more options. Select the icon you wish to use for the source and click **OK**.

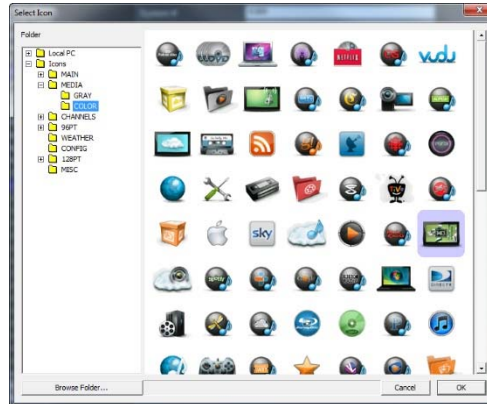

5. Check the **Display Name** entry. The name should be user friendly, like “SAT Theater TV”. *The Display Name is what will appear in the Viewer.*
6. Click **Apply** when finished.
7. Add the remaining sources, BDP and Integra Internal Tuner as follows
 - a. Select the **(BD/DVD)** source. From the Source Device drop-down list, select **Interface:BDP**, select an icon and check the display name, then click **Apply**.
 - b. Select the **(AM/FM)** source. From the Source Device drop-down list, select **Tuner: Integra DTR Internal AM/FM Tuner**, select an icon, rename to **Theater Radio**, and then click **Apply**.
 - c. The Home Theater Receiver should now show sources assigned to the Source inputs, similar to the example shown below.

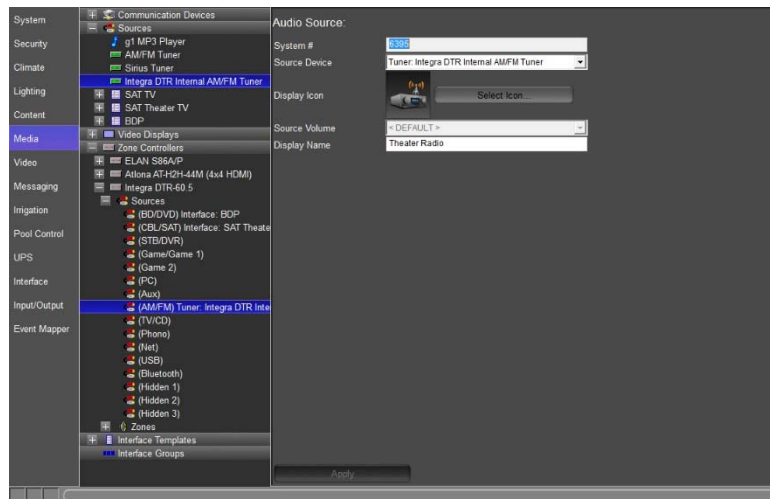

Exercise 5: Output from Zone

Overview In many installations, customers want to be able to play the Whole House Audio (WHA) sources through another device, such as a surround sound receiver in a theater or bedroom. ELAN uses the concept of **Output From (zone)** to accomplish this without needing to write complex macros.

In this setup, a zone pre-out from the whole house audio equipment is wired to a single input on the rear of a receiver in the home theater. In addition, an output from the whole house video equipment is also wired to the Receiver in order to provide video as well as audio in the Theater zone.

In the Configurator, an output zone from the WHA system is assigned as a *source* on the receiver. The Viewer then populates the available audio sources from the WHA zone controller in the zone (or zones) for the surround receiver. If a source from the WHA is selected in the Viewer, ELAN sends a signal to the WHA system to switch to that source. Any local sources on the receiver will still function as expected.

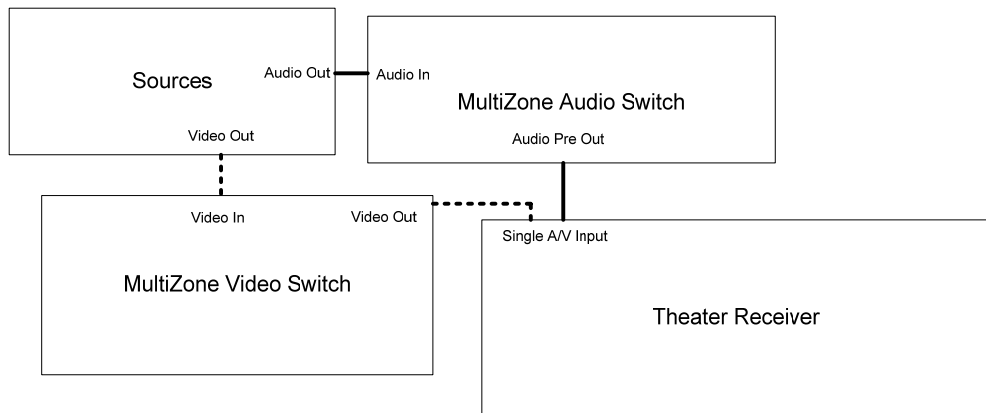

The following example describes how to set up an ELAN S86A and Atlona AT-HD-V44M with a zone output to an Integra DTR-60.5 Surround Sound receiver.

How-to

1. Add the Atlona AT-HD-V44M Zone Controller. Remember to add a Communication Device first.
2. To send video along with the audio from the Multi Zone M86A/AT-HD-V44M, configure the AT-HD-V44M zone prior to configuring zone slaving:
 - a. On the **Media** tab, locate the Atlona under **Zone Controllers**. Click the plus “+” sign next to Zones to expand the Zone list, and select **AT-HD-V44M Output 3**.
 - b. In the Zone Properties pane on the right, select the name “AT-HD-V44M **Output 3**” at the top and enter “**Theater Zone Video**” to rename this zone. Naming the zone will help us keep track when configuring Slave and “Output” relationships between zone controllers.

c. Click **Apply**.

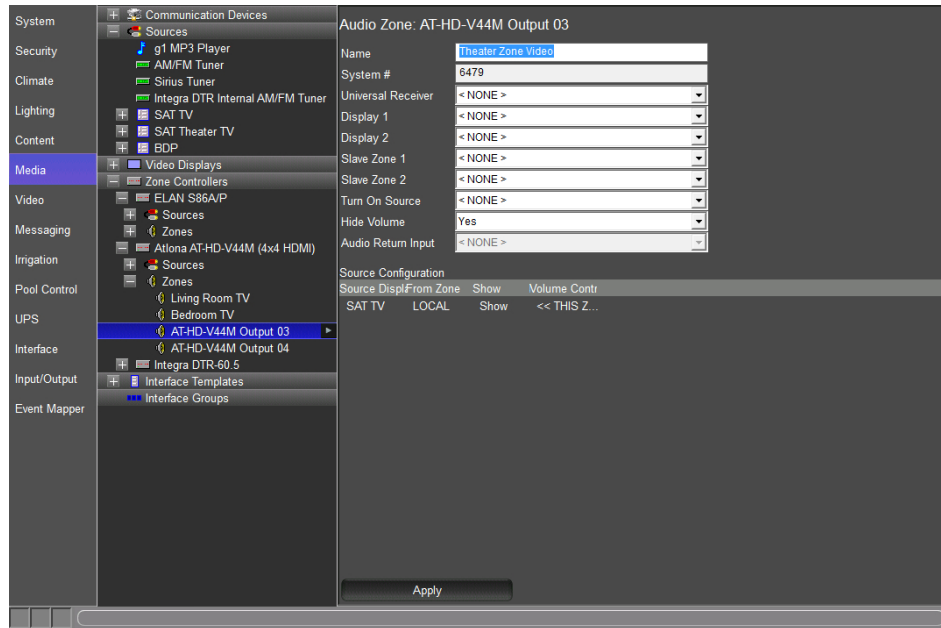

3. Configure the S86A “source” zone to send audio and video to the Theater Receiver by setting up the Atlona zone as a slave on the S86A zone.
 - a. Click the “+” next to **Zones** under the **ELAN S86A/P** Zone Controller to expand the zone list, and then select **Zone 3**.
 - b. In the Zone Properties pane on the right, select the name “**Zone 3**” at the top and enter “**S86 Theater**”.
 - c. Select Atlona AT-HD-V44M **Zone 3 (Theater Zone Video)** from the **Slave Zone 1** drop-down list. *This will link the AT-HD-V44M Theater zone to the S86 Theater zone. The Slave 1 Source column in Source Configuration matrix populates with the words “Don’t Change” for each of the available sources.*

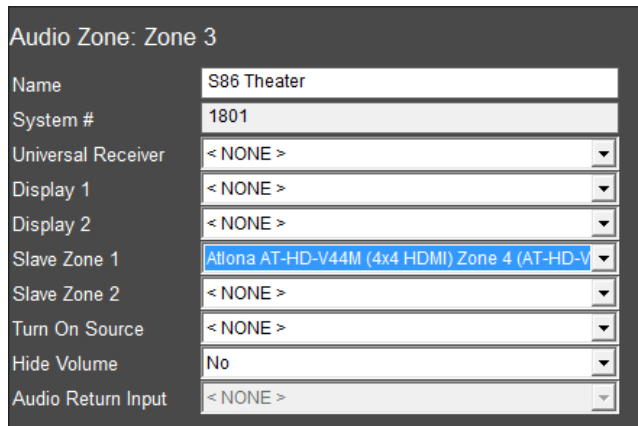

- d. **Source 4 (SAT TV)** in the Source Configuration section is an A/V source. For this source, right-click **Don't Change** in the **Slave 1 Source** column to popup the list of sources on the AT-HD-V44M. Select the **Source 1 (SAT TV)** source from the list. *Leave the audio only sources as "Don't Change"*.

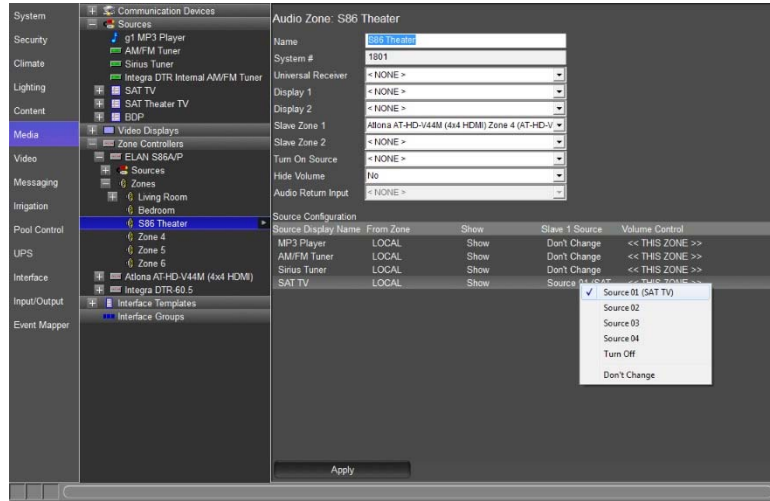

- e. When finished, click **Apply**. *The desired video sources will now switch with the S86A Audio zone.*

4. Assign the S86A Theater Zone Output as a source to the Home Theater Receiver:

- a. Navigate to the **(AUX)** source on the **Integra DTR-60.5**. In the **Source Device** drop-down, select **Output From: ELAN S86A/P: S86 Theater**.
- b. Click **Apply**.

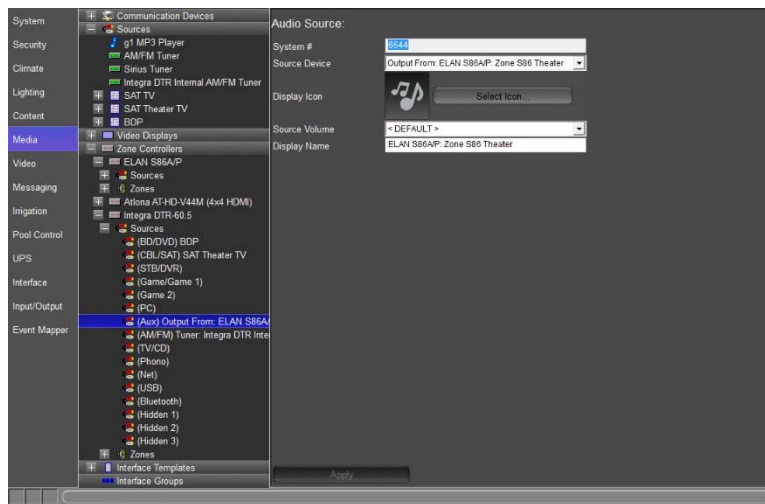

Note: It is not necessary to enter a Display Name or select a Display Icon, as this information is not displayed in the Viewer. The source names and icons will carry over from the S86A "source" zone.

- c. Check the Zone properties for **MainZone** on the Integra Receiver. At the bottom of the page under **Source Configuration**, notice that all the sources added to the S86A display in addition to the sources on the Integra. The S86A zone will turn on and select sources automatically when they are activated from the Integra Zone. The Integra will maintain the single input selection and provide all volume control locally when “**Output From...**” sources are selected.

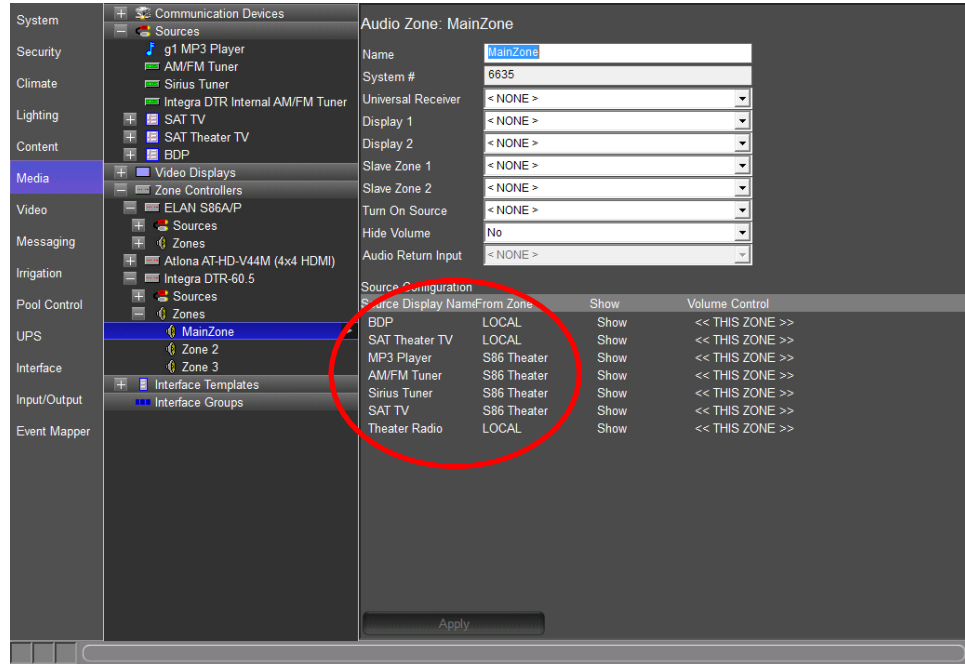

Exercise 6: Add a Serial Driver for a Video Display

Overview In Exercise 6, you will add a driver for the Display in the theater zone to the Configurator.

In the g! software, displays are set up independently in the Configurator, and then assigned to a zone. The g! software has pre-configured commands for display drivers. Drivers are added to the system in the Input/Output tab first and then accessed in the Media tab when a Custom Display is added.

How-To

Add the Serial code file for the Theater TV to the Input/Output Tab

1. In the Configurator, navigate to the **Input/Output** tab.
2. Right-click **Communication Devices** in the System Node Tree and select **"Add New Communication Device"**. *The Add New Communication Device window opens.* In the dialog box:
 - a. Enter "Sharp Theater TV" as the Device Name.
 - b. **Communication Type** select **Standard Connection**.
 - c. **Hardware Type** select **Serial Port**.
 - d. Select an **Unassigned COM Port** in the **COM Port** drop-down box.

Note: Choose the COM Port the device is physically connected to on the g controller. Choosing the incorrect COM Port will result in the device not responding to commands for the g controller.

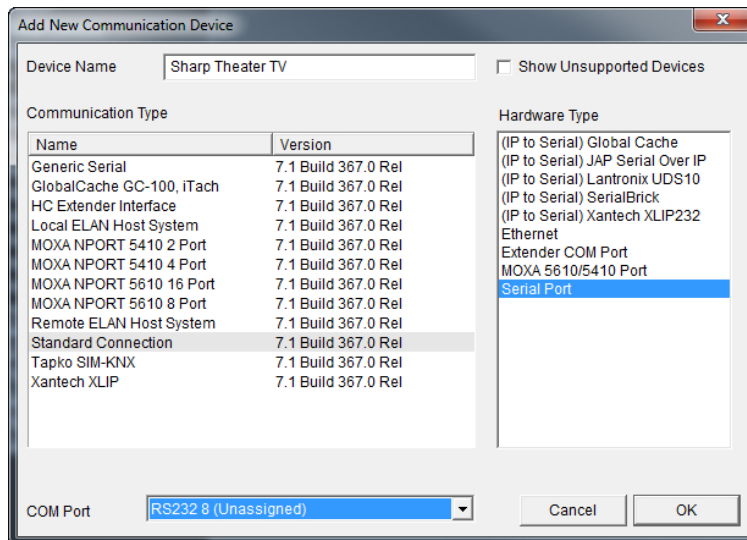

- e. Click **OK**.

3. Navigate to the **Generic Serial Devices** node and **right-click**.
 - a. Select **Add New Generic Serial Device**. *The Add New Generic Serial Device window appears.*
 - b. Name the device **Sharp Theater TV**.
 - c. Select the **Generic Serial Device** device type.
 - d. Click **OK**.

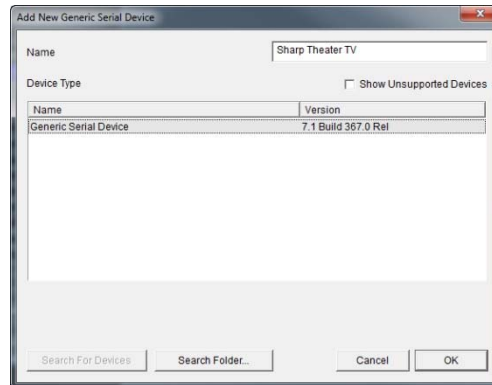

4. Verify the Sharp Theater TV is connected to the Sharp Theater TV communication device.

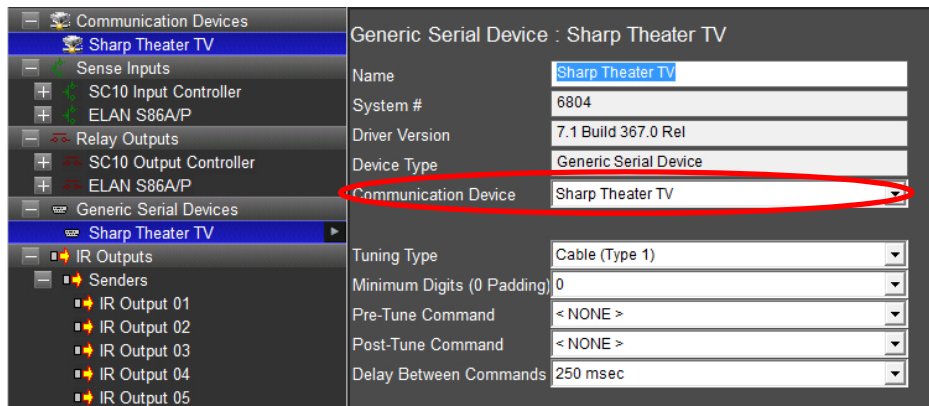

5. Right-click **Sharp Theater TV** and select **Import from File**. *A window will pop displaying the Serial Library folder in g!Tools.*

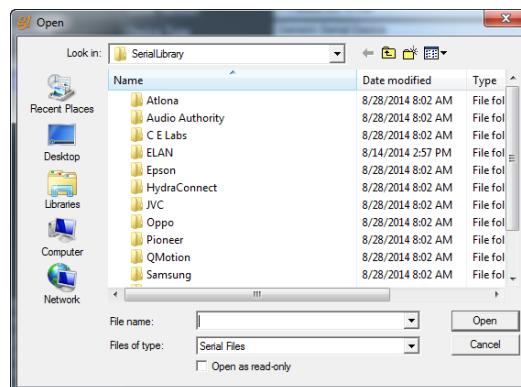

- Click on the **Sharp** folder and select **Open**.

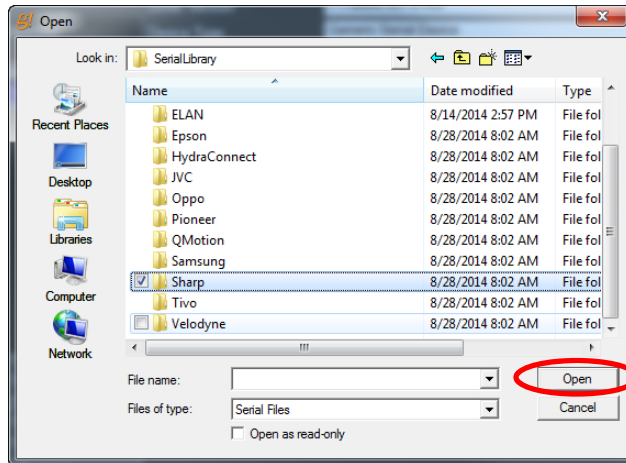

- Click on the **Television** folder and then select **Open**.
- Click on the **Sharp 60 70 80.HSR** file and then select **Open**.

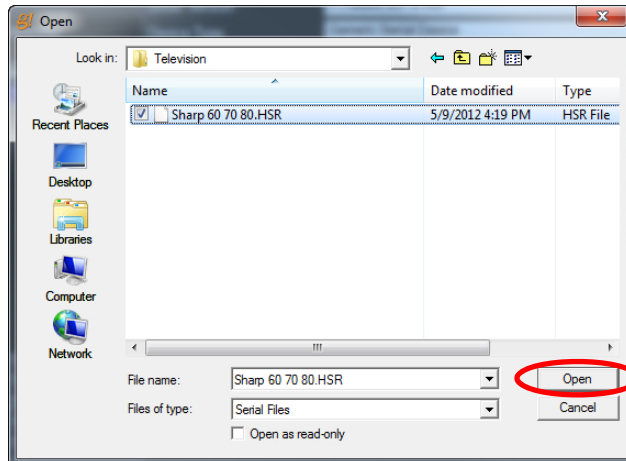

- Click on the **+** to expand the **Sharp Theater TV** and verify the codes imported correctly.

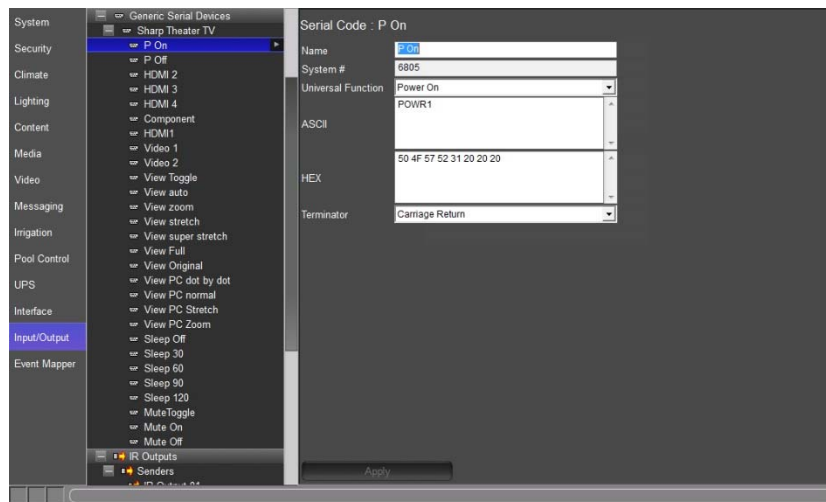

Exercise 7: Add the Video Display in the Media Tab

Overview In Exercise 6, you learned how to add a serial driver for use with a video display. In this exercise we will add the video display in the Media tab and associate commands from the serial driver to the video display. Before beginning, be sure that you have completed the previous exercises from this lesson.

Adding a display in the Media tab makes the display available for assignment to a audio zone and/or allows the video display to be used as a Zone Controller.

Quick Reference: Custom Video Display	
Name	Editable field used to name the video display.
System #	Unique, read-only number assigned by the g! software for internal use.
Driver Version	Core module rev the driver was last verified in.
On Off Control Type	How the display is turned on. Options are: Cycle (Tracking Enabled) – Uses the same command to turn the video display on and off. Tracking enabled allows g to track the On/Off status of the display. Cycle (Tracking Disabled) - Uses the same command to turn the video display on and off. Tracking disabled means g will not track the On/Off status of the video display. Discrete – The g system will send the power on or power off command when requested. Discrete Verify (Always Send) – The g system will send the power on or power off command every time a source associated to the video display is selected.
Source Control Type	Cycle - Uses a single command to toggle between the available source inputs. Discrete – The g system will send the individual command for the specified source input. Discrete Verify (Always Send) – The g system will send the individual command for the specified source input every time a source is selected that is associated to an input on the video display.
Delay After On/Off	The amount of time that has to expire before the video display can accept another command. Time setting is in milliseconds from 100 to 14900.
Delay After Source	The amount of time that has to expire before the video display can accept another command. Time setting is in milliseconds from 100 to 14900.
Volume Control	Allows the volume to be adjusted for the video display from a g User Interface.
Mute Control Type	Sets how the video display will use the mute command. None – There is no mute command for the video display. Toggle – There is a single command for mute that toggles between mute on and mute off. Discrete – There is a separate mute on and separate mute off command for the video display that is managed by g.
Provide Local Sources	Set to Yes when the area will be split between 2 zone controllers (i.e. an MRA & a Video Display) with independent volume control for both zone controllers.

Provide Audio Return	Set to Yes when connecting the audio output from a video display to an audio input on a zone controller (i.e. AVR, MRA, GSZC) in order to enable the Audio Return Input option in the zone node of a zone controller.
ELAN UltraMatrix ARP	Set to Yes if ARP (Audio Return Program) will be a source option for the ELAN gMV UltraMatrix. This option is greyed out if no gMV is being used in the system.
Show as Zone	Set to Yes to show the video display as an independent zone.
Controller Commands	Shows the available command names that are associated with the video display. Selecting a command name brings up the Command window for adding Serial or IR commands.

How-To

Add a video display for the Theater Zone

1. In the Configurator, on the **Media** tab, right-click the Video Displays node and select **Add New Video Display**. *The Add New Video Display window appears.*
 - a. Enter **Sharp Theater TV** in the Name field.
 - b. Select the **Custom Video Display** Device Type.

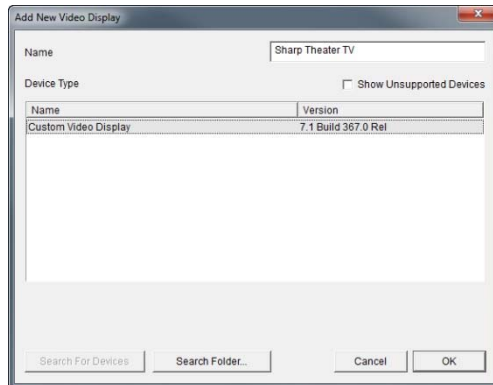

- c. Click **OK**. *The Sharp Theater TV appears in the Video Displays node.*

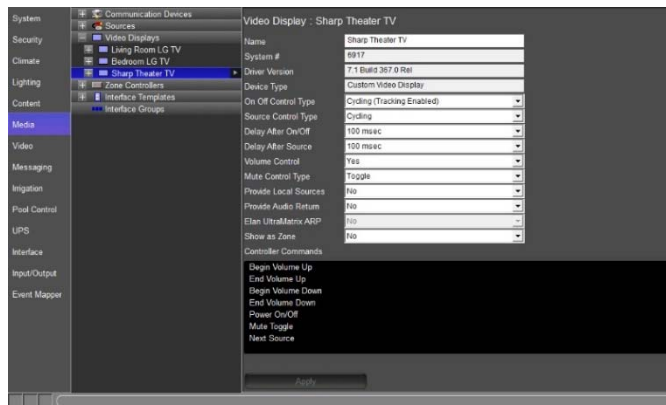

- Click the **On Off Control Type** drop down and select **Discrete**. *The Controller Commands section in the Properties Pane now shows Power On and Power Off command names.*

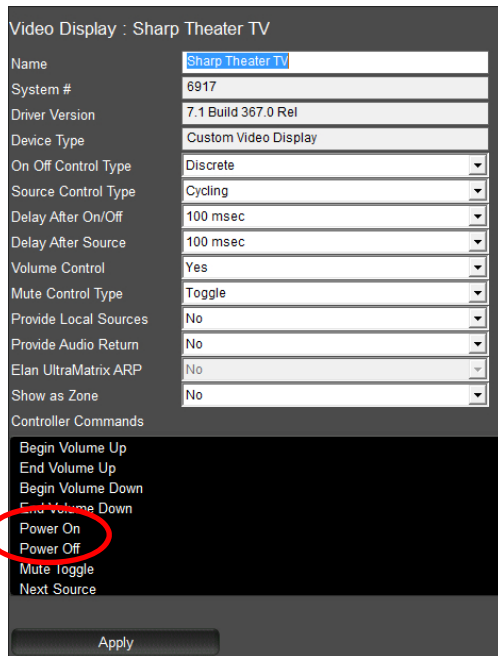

- Click the **Source Control Type** drop down and select **Discrete**. *The Controller Commands section in the Properties Pane now shows (Source 01) command name.*

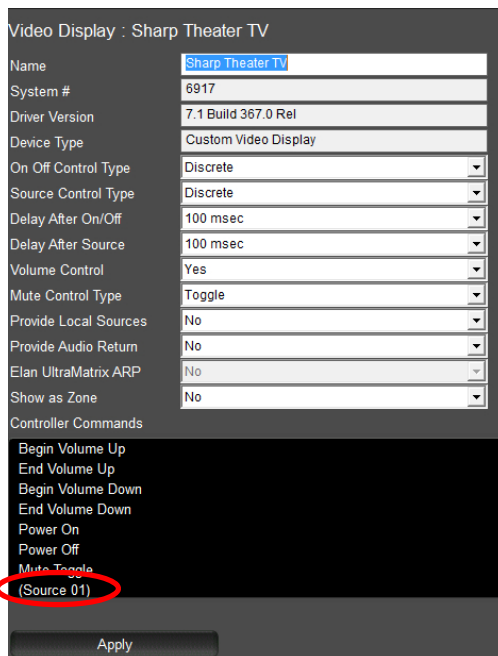

- a. If more than 1 input on the TV is being used add additional sources to the video display in the system node tree by **right click** on the (Source 1) node and selecting **Add New Source**.

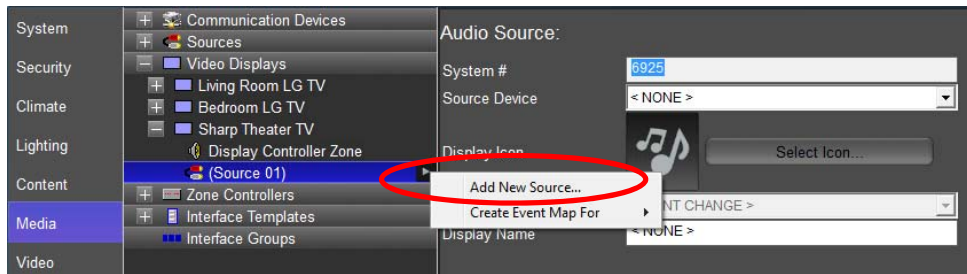

- b. In the Add New Source window **name the input** being used on the TV and select **OK**.

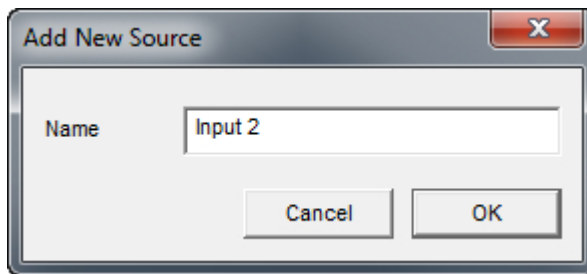

- c. (Source 2) appears below (Source 1). Verify that the Display Name is labelled correctly.



Note: The Display Name will only be shown in the gViewer if using the video display as a Generic Zone Controller.

- d. When finished adding sources, return to the **Video Display Properties** by selecting the **Sharp Theater TV** node.

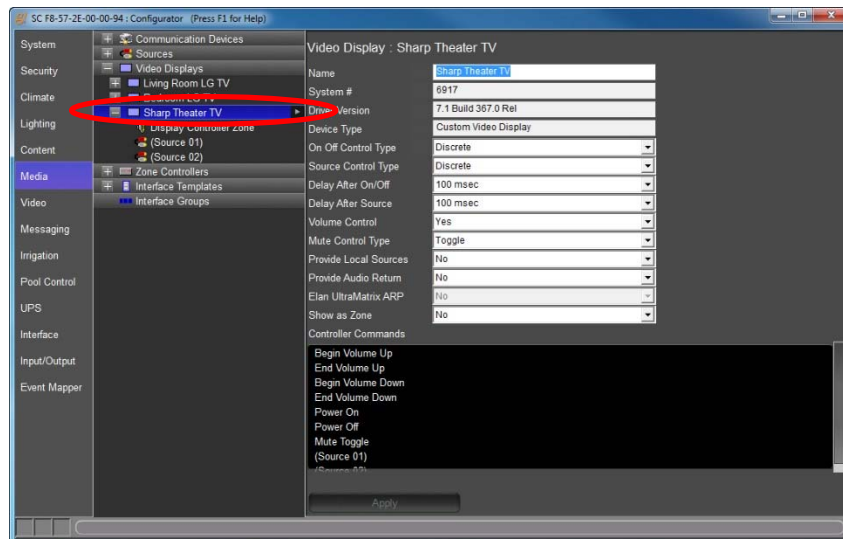

4. Make any adjustments from 100 msec to 14900 msec for the **Delay After On/Off** and **Delay After Source** delay times using the drop down arrow. *These adjustments can be made later if desired.*

Video Display : Sharp Theater TV	
Name	Sharp Theater TV
System #	6917
Driver Version	7.1 Build 367.0 Rel
Device Type	Custom Video Display
On Off Control Type	Discrete
Source Control Type	Discrete
Delay After On/Off	500 msec
Delay After Source	700 msec
Volume Control	Yes
Mute Control Type	Toggle
Provide Local Sources	No
Provide Audio Return	No
Elan UltraMatrix ARP	No
Show as Zone	No

5. The **Volume Control** drop down may be set to Yes if the volume of the video display is to be adjusted from a g User Interface. Set the Volume Control drop down to **No** for this exercise. *The Mute Control Type field is greyed out and no longer able to be adjusted.*

Video Display : Sharp Theater TV	
Name	Sharp Theater TV
System #	6917
Driver Version	7.1 Build 367.0 Rel
Device Type	Custom Video Display
On Off Control Type	Discrete
Source Control Type	Discrete
Delay After On/Off	500 msec
Delay After Source	700 msec
Volume Control	No
Mute Control Type	None
Provide Local Sources	No
Provide Audio Return	No
Elan UltraMatrix ARP	No
Show as Zone	No

6. **Mute Control Type** sets how the video display will use the mute command:
- Set to **Toggle** if there is a single command for mute that toggles between mute on and mute off.
 - Set to **Discrete** if there is a separate mute on and separate mute off command for the video display that is managed by g.
 - Set to **None** if there is no mute command for the video display.

The next steps are used when a video display will be used as a zone controller and for sending audio from its Audio Output to a Source Input on the audio zone controller, and setting up the video display for use as a zone controller. The following steps are not used in this lesson and are for reference purposes only.

Please proceed to step 11.

7. Set the **Provide Local Sources** drop down to Yes when the area will be split between 2 zone controllers (i.e. an MRA & a Video Display) with independent volume control for both zone controllers. Leave this option set to **No** for this exercise.
8. Set the **Provide Audio Return** drop down to Yes when connecting the audio output from a video display to an audio input on a zone controller (i.e. AVR, MRA, GSZC) in order to enable the Audio Return Input option in the zone node of a zone controller. Leave this option set to **No** for this exercise.
9. The **ELAN UltraMatrix ARP** drop down is set to Yes if ARP will be a source option for the ELAN gMV UltraMatrix. This option is greyed out when no gMV is being used in the system.
10. The **Show as Zone** drop down should be set to Yes when the video display will be used as an independent zone in the system. Leave this option set to **No** for this exercise.

Video Display : Sharp Theater TV	
Name	Sharp Theater TV
System #	6917
Driver Version	7.1 Build 367.0 Rel
Device Type	Custom Video Display
On Off Control Type	Discrete
Source Control Type	Discrete
Delay After On/Off	500 msec
Delay After Source	700 msec
Volume Control	Yes
Mute Control Type	Toggle
Provide Local Sources	No
Provide Audio Return	No
Elan UltraMatrix ARP	No
Show as Zone	No

11. Verify the Controller Commands section looks similar to the below image:



a. Select **Power On** from the Controller Commands section. *The Commands window appears.*

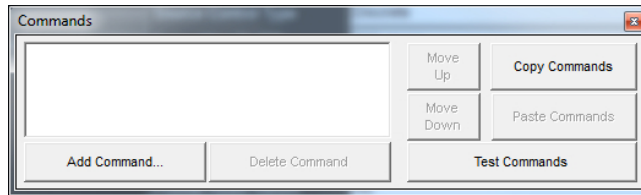

b. Click **Add Command**. *The Add Command window appears.*

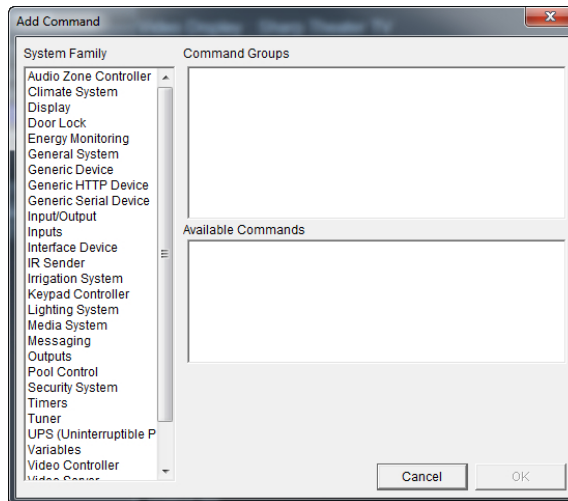

c. In the System Family section of the Add Command window, locate and select the **Generic Serial Device**. *System Family is where device commands are grouped for easy access in the Add Command window.*

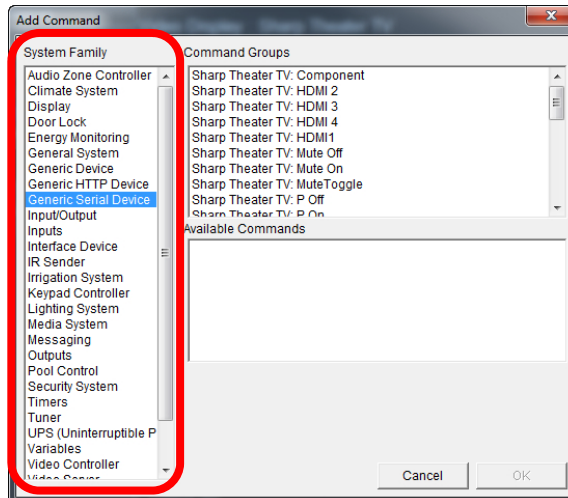

- d. In the Command Groups section, locate and select the power on command for the display. In this exercise use the **Sharp Theater TV P On** command. *Command Groups displays the available commands for the selected System Family.*

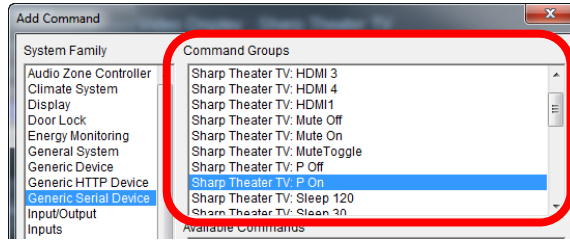

- e. In the Available Commands section, locate and select the **Send via Default Device** command. *The Available Commands shows what commands are available for the selected command group:*

- i. **Send via Default Device:** Sends the command out of the previously assigned Serial Port.
- ii. **Send via Device:** Sends the command out of a Serial Port that is different than what was previously assigned.

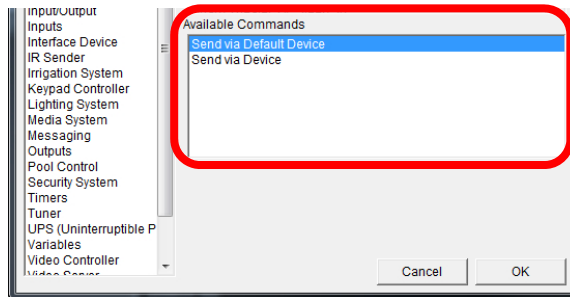

- f. Select OK to save the command and return to the Commands window. Your Commands window should look similar to below:

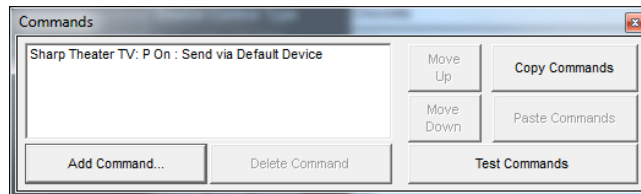

- g. Repeat steps a thru f to add the Power Off, (Source 1), and (Source 2) commands and proceed to **Exercise 8** when finished.

Exercise 8: Assign a Display to a Zone

Overview In Exercise 8, you will set up the Theater zone to use the display added in Exercise 7. Before beginning, be sure that you have completed the previous exercises from this lesson.

Assigning a display to a zone provides the ability to send power and input commands to the display, based on which source is selected.

- How-To**
1. In the Configurator, on the **Media** tab, click the plus (+) sign to expand the **Zone Controllers** node, and click the plus (+) sign to expand the **Zones** node for the Integra DTR-60.5 receiver.
 2. Click **Main Zone** in the Zones list. *The Main Zone properties display in the Properties Pane to the right.*
 3. From the **Display 1** drop-down list, select the **Sharp Theater TV** and click **Apply**. *The Source Configuration matrix will change to reflect the available display commands for each source.*

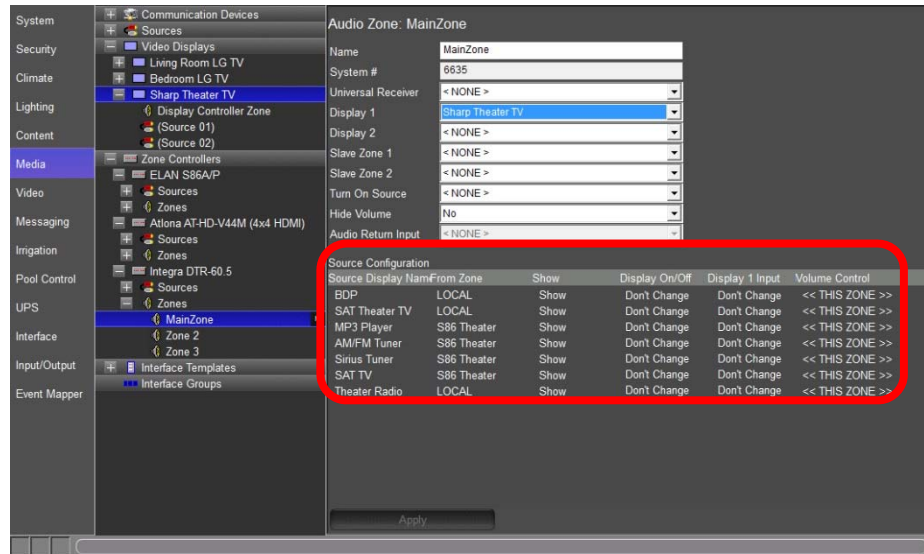

Quick Reference: Zone Configuration	
Name	Editable field used to name the zone.
System #	Unique, read-only number assigned by the g! software for internal use.
Universal Receiver	Zone IR Receiver assignment.
Display 1	Drop-down field used to select the first television display assigned to the zone.
Display 2	Drop-down field used to select the second television display assigned to the zone.
Slave Zone 1	Drop-down field used to assign a zone output from a video switcher to Display 1.
Slave Zone 2	Drop-down field used to assign a zone output from a video switcher to Display 2.
Turn On Source	Drop-down field used to select a default source when the zone is turned on with a "Zone On" command.
Source Configuration	<p>Matrix view of the available sources in this zone. To change any of the settings in the matrix, right-click the setting you want to work with to display a popup menu of options. Select the appropriate option from the list.</p> <p>Use the matrix to configure the following:</p> <p>Source Display Name. Lists the name for the source as it will display in the Viewer. Right-click the source name to move it up and down in the list, which will change the order the sources are shown in the Viewer.</p> <p>From Zone. Displays the name of the zone the source is directly connected to.</p> <p>Show. This Yes/No option controls whether (or not) this source will be displayed in the Viewer.</p> <p>Display On/Off. This On/Off option controls the behavior of video display(s) when the source is selected. When 2 video displays are used in a zone the TV management for power on and off is done thru the Source Selection page of the Viewer.</p> <p>Display 1 Input. Select the input that Display 1 should switch to for the selected source device. This column will only be available when a display is selected in the Display 1 field described above.</p> <p>Display 2 Input. Select the input that Display 2 should switch to for the selected source device. This column will only be available when a display is selected in the Display 2 field described above.</p> <p>Slave 1 Source. Map the appropriate source from the video switcher to show on Display 1 when this "Source Display Name" is selected. This will only be available when a selection is made in the Slave Zone 1 field above.</p> <p>Slave 2 Source. Map the appropriate source from the video switcher to show on Display 2 when this "Source Display Name" is selected. This will only be available when a selection is made in the Slave Zone 2 field above.</p> <p>Volume On Source. This column controls the power state of the audio zone controller when a source connected to the video display is selected in the zone. The available options are:</p> <p>Turn On – turns the audio zone controller on when the display source is selected.</p>

	<p>Turn Off – turns the audio zone controllers off when the display source is selected. This is the default setting from the factory.</p> <p>Don't Change – leaves the audio zone controller in the power state it was already in when the video display source is selected.</p> <p>Volume Control. Map each source to the appropriate audio zone controller/audio zone for volume control. This is only necessary when there is more than one audio source in a single zone.</p>
--	--

4. For this example, we will assume that the Receiver is acting as a video switcher and that there is a single video connection from the receiver to the connection “(Source 1)” on the display. For each source, we need to specify the displays power state and which input the display should use. We will start by configuring how the video display reacts when a LOCAL source is selected in the zone.
 - a. In the Source Configuration matrix, configure the display settings for the **BDP** input row. This source is a LOCAL Blu-Ray disc player, so the display for the zone should be turned on when this source is selected.
 - b. Right-click **Don't Change** in the **Display On/Off** column directly to the right of the Input Name, BDP. A popup window will appear showing your options:

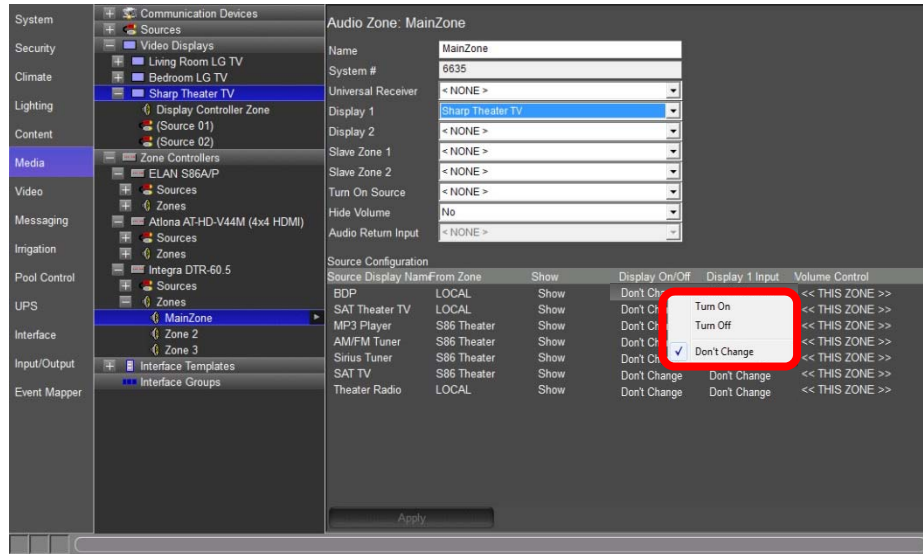

- c. Select **Turn On** for this source. The entry in the **Display On/Off** column will update to reflect your choice.
- d. Set which input the display should go to when the BDP is selected by moving one column to the right in the BDP source row to the Display 1 Input column. Right-click **Don't Change** to display available choices. Select **(Source 1)**.

e. Repeat steps a thru d to set the display for the **SAT Theater TV & Theater Radio** sources and select **Apply** when finished.

i. **SAT Theater TV** selected:

1. Display On/Off: **Turn On**
2. Display 1 Input: **(Source 1)**

ii. **Theater Radio** selected:

1. Display On/Off: **Turn Off**
2. Display 1 Input: **Don't Change**

5. When finished your screen should look similar to the image below:

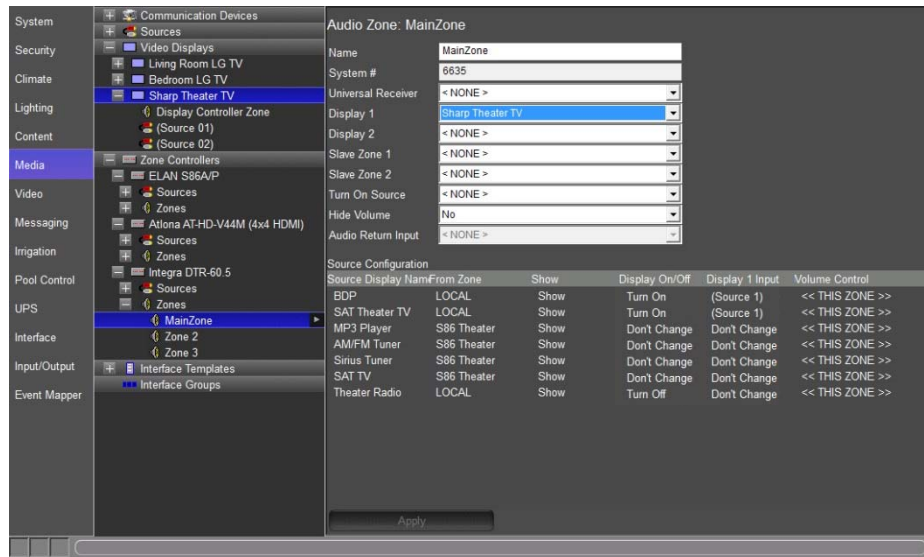

6. The next steps go over setting up the display for the sources being sent from the S86 Theater Zone's output (Output from ELAN S86A/P: S86 Theater). The S86 Theater Zone was previously setup in Exercise 5 to control the Atlona AT-HD-V44M when the SAT TV source was selected.

Note: Exercise 5, Output From A Zone, should be completed before proceeding.

- a. In the Source Configuration matrix, configure the display settings for the **S86 Theater** source rows.
 - i. **MP3 Player** selected:
 1. Display On/Off: **Turn Off**
 2. Display 1 Input: **Don't Change**
 - ii. **AM/FM Tuner** selected:
 1. Display On/Off: **Turn Off**
 2. Display 1 Input: **Don't Change**
 - iii. **AM/FM Tuner** selected:
 1. Display On/Off: **Turn Off**
 2. Display 1 Input: **Don't Change**
 - iv. **SAT TV** selected:
 1. Display On/Off: **Turn On**
 2. Display 1 Input: **(Source 1)**

Note: In Exercise 5 the Atlona video switch was set up to switch to its SAT TV (source 1) input when the SAT TV source was selected in the S86 Theater Zone. This setting does not need to be duplicated here.

7. When finished select **Apply** and verify your screen looks similar to the image below:

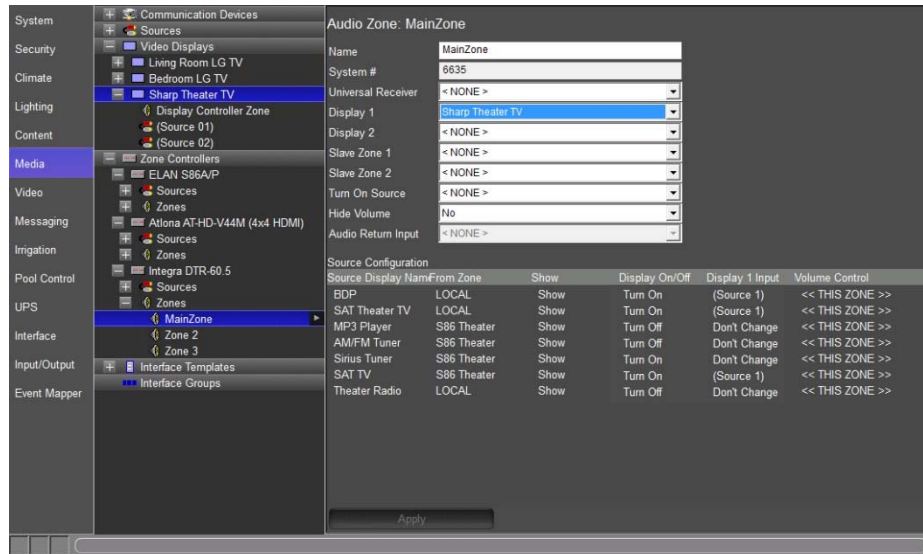

Exercise 9: Configure the Zones

Overview Before beginning Exercise 9, be sure you have completed the previous exercises of this lesson. In this exercise, you will set up the Zone Names and Settings pages for the Theater Receiver, and remove unused zones from the Viewer interface.

Giving the zones user-friendly names provides the user with an intuitive interface for controlling the audio in their home. Remove unused zone controls from the Viewer interface to prevent confusion on the part of the homeowner, and to prevent them from turning on a zone to which no speakers are connected.

The optional settings interface gives the user access to less commonly used functions, such as bass, treble, and Listening Modes.

Note: On some surround sound receivers, the Settings interface will give the user access to various listening modes. See the *Integration Notes* for the specific receiver for details.

How-to

1. In the Media tab, Zone Controller node, click the plus (+) sign to expand the **Zone** node for the **Integra DTR-60.5** receiver.
2. Click on **Main Zone** in the zone list. *The properties for Main Zone will display on the right.*
3. Change the name to **Theater** in the Name field, then click **Apply**. *The label of the zone will change in the Zones List to reflect the new name.*
4. Right-click the Theater zone in the system node tree and select **Create Settings Page for this zone**. *A new entry will be added under the zone name called **Theater: Settings**. Your screen should now look similar to the image below.*

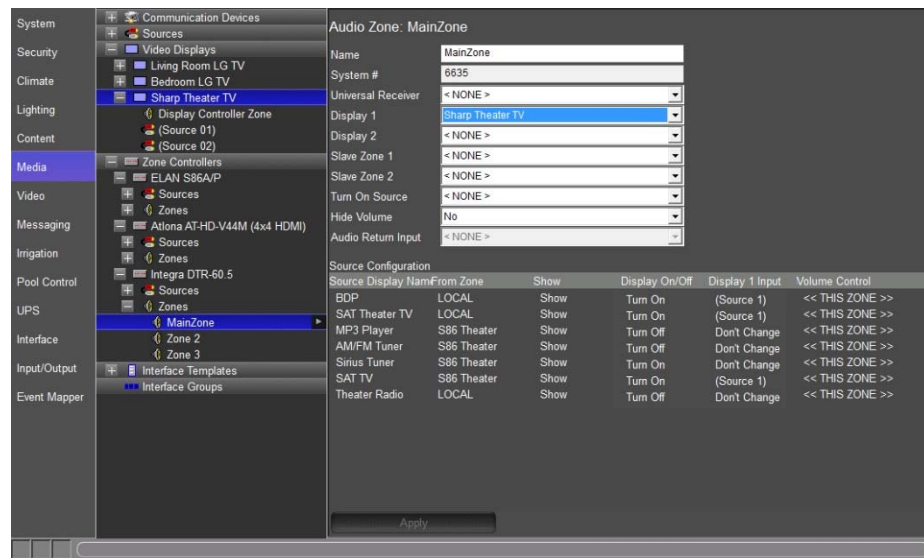

5. Click the plus (+) sign next to Theater: Settings to expand the list.
 - a. Select the Large Format, and then Large Landscape (WIDE) to display a representation of the settings page for this zone.

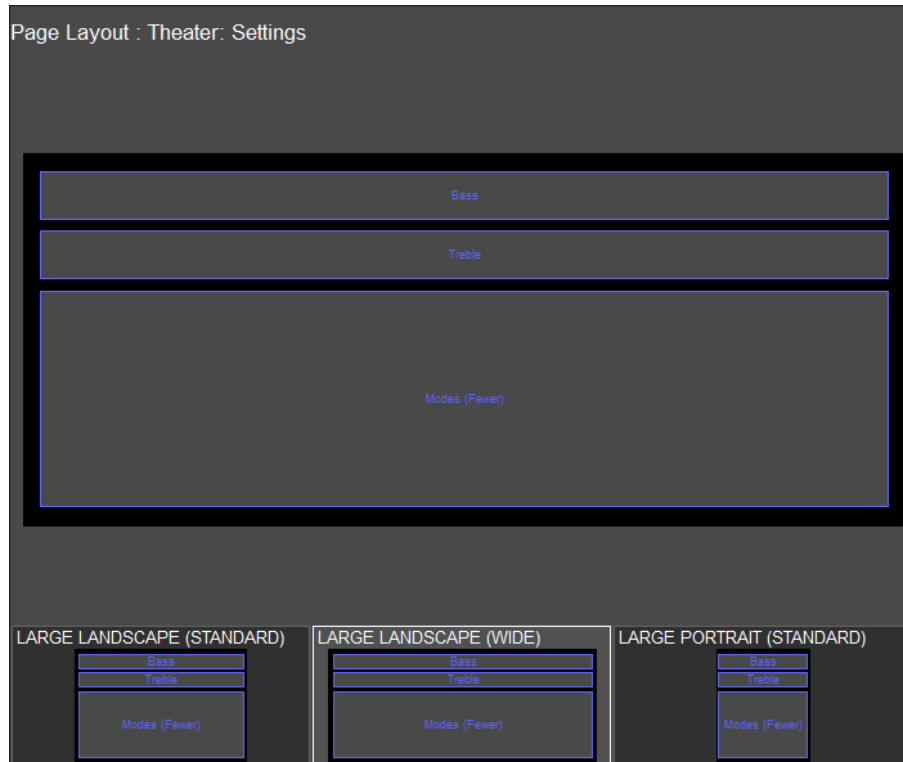

Note: The Settings page will auto-populate different controls depending on which commands are supported by the receiver.

- b. Select the top object in the Interface Layout, labeled “Bass”. *The control will be highlighted in yellow and the Audio Sound Adjust Properties window opens.*

Note: In the Viewer, this object appears as a Bass tone control slider, allowing the user to increase or decrease the bass in the zone.

- c. Verify the following properties in the **Audio Sound Adjust** window:
 - The Name field is “Bass”. This corresponds to the label on the control.
 - The **Style** drop-down is set to **Bass Control**.
 - The **Connect To** drop-down is set to **Theater**, indicating that this is the zone the slider controls.

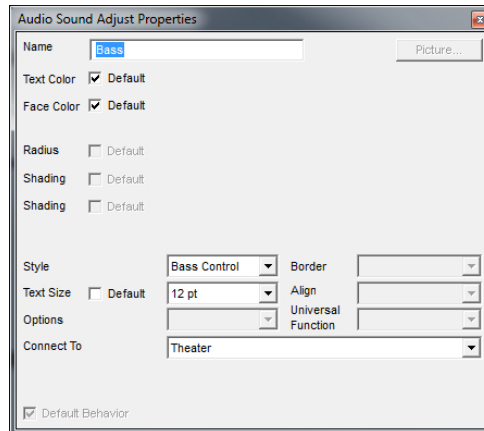

Note: The Settings page is fully customizable and any of the objects on this page can be moved and resized so that other controls can be added.

6. Verify the additional control types and proceed to step 7 when finished.
7. To remove the unused zones from the Viewer interface, go to the **Interface** tab in the Configurator.
8. Under **Touch Screen Options** near the top of the System Node Tree, click the plus (+) sign to the left of the **Windows** option to expand the list:
 - a. Under the heading **Tab Layouts**, select **Media System** to view the following screen:

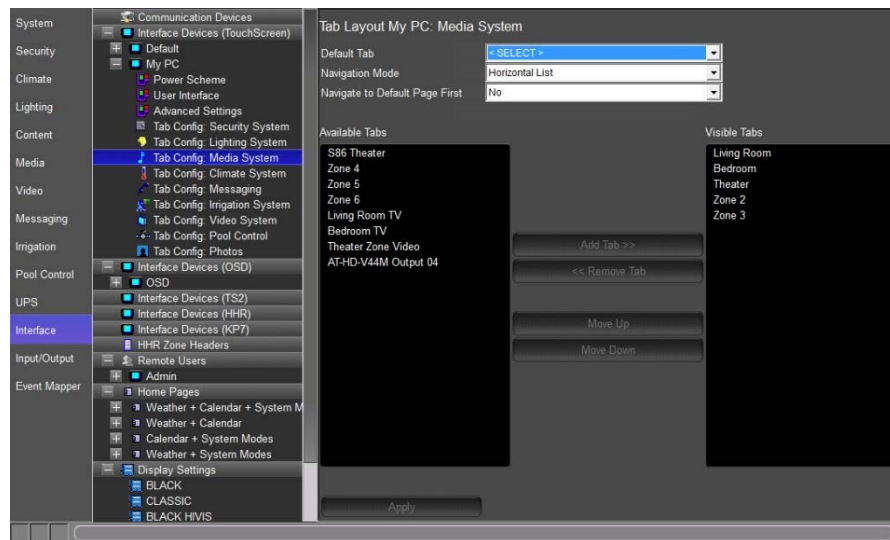

- b. The properties window is divided into two columns, **Available Tabs** and **Visible Tabs**. Items listed under Visible Tabs are available for interaction in the Viewer software. Because we are not using Zone 2 or Zone 3 on the Integra receiver, we need to remove them from the Viewer.
- c. In the **Visible Tabs** column, click on **Zone 2**, click the **Remove Tab** button in the center, click on **Zone 3**, click the **Remove Tab** button in the center, and then click **Apply**. *Zone 2 & Zone 3 will move from the Visible Tabs column to the Available Tabs column.*

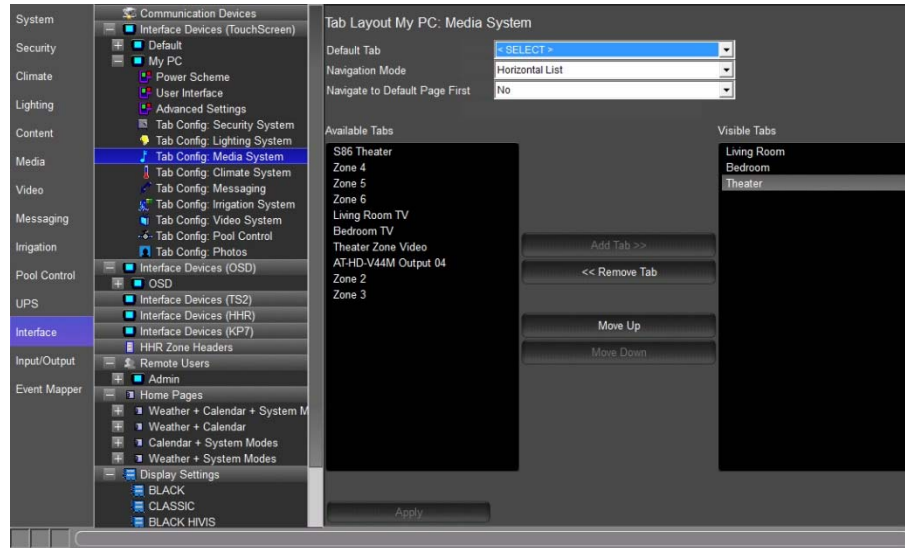

Note: This step simply removes the zone from the Viewer software on a per-screen basis, it is not deleted and can be added back into the viewer at any time should the homeowner decide to expand their system. Each touch screen must be configured separately.

Exercise 10: Check the Viewer Interface

Overview In Exercise 10, you will check your work in the Viewer. Before beginning, be sure you have completed all of the previous exercises in this lesson.

In addition to the Viewer, you will use the “Show Virtual Display” feature in the Configurator. This tool shows the expected power and source state for a display configured in the software.

How-To 1. In the Configurator, select the Media tab. Right-click **Sharp Theater TV** in the Video Displays node, and then select **Show Virtual Display**. *The Sharp Theater TV Virtual Display Window will open:*

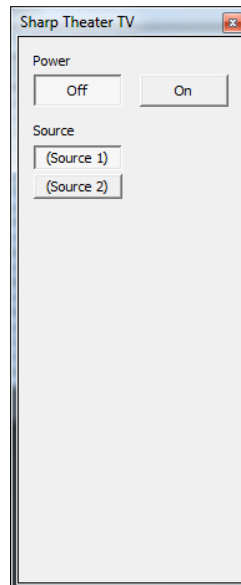

2. Right-click the **Integra DTR-60.5 Theater** zone under the Zone Controllers node, and select “**Show Virtual Zone**” from the pop-up options. *The Virtual Theater Zone is displayed:*

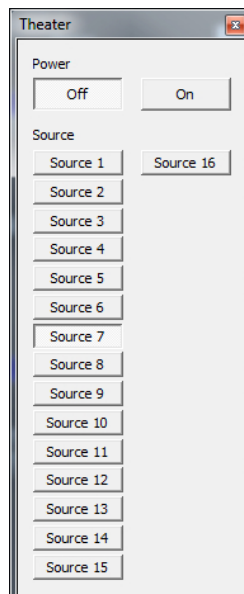

- Right-click the **S86 Theater** zone in the Zone Controllers node, and select “**Show Virtual Zone**” from the pop-up options. *The Virtual S86 Theater Zone is displayed:*

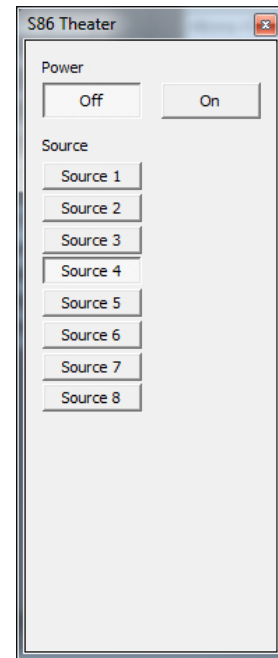

- In the upper right corner of the Configurator window, click the **Minimize Down** button to take the Configurator out of full screen mode:



- From the g!Tools My Systems screen, click the **Viewer** button. The Viewer interface displays the Main Menu. Click the Media icon.



- Click the **Theater** icon to access the Theater zone user interface.

7. Arrange the windows on your desktop so that you can see the Viewer, the Virtual Zones and the Virtual Display window as shown below.



On this screen notice:

- The Sources are listed.
 - The Source Name and Icon match those configured in the previous exercises.
 - The Theater zone is off and the Theater TV is off.
 - The Sources configured locally on the Integra Receiver appear.
 - The sources from the ELAN S86 Theater zone output appear as well.
8. Select the **SAT Theater TV** source. Notice the following:
- The Virtual Display window indicates that the display has turned on and selected Slot 1.
 - The Virtual Theater Zone indicates the Integra has turned on and selected the SAT Theater TV input (Source 2).
 - The Virtual S86 Theater Zone indicates the S86 Theater zone has made no change, and remains off.
 - The interface changes to provide the controls configured in previous lessons for the SAT Theater TV.
 - The zone's active source icon and name in the lower left has changed to reflect the source selected in the zone.



9. Select the **MP3 Player** source. Notice the following:

- The Virtual Display window indicates that the display has turned off.
- The Virtual Theater Zone indicates the Integra has selected the Aux Input (Source 7).
- The Virtual S86 Theater Zone indicates the S86 Theater zone has turned ON and selected Source 1.
- The interface changes to provide the built-in controls for the MP3 Player.
- The zone's active source icon and name in the lower left has changed to reflect the source selected in the zone.

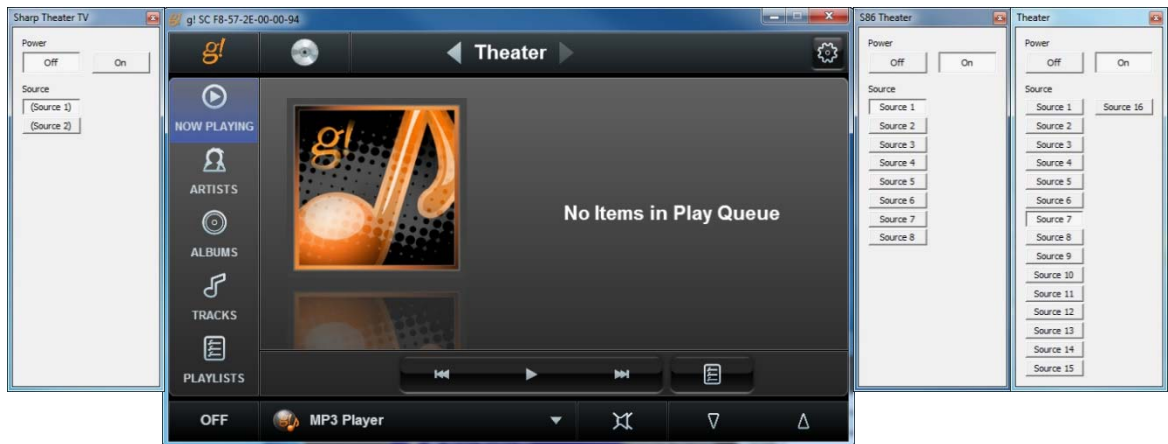

10. Select the **SAT TV** source. Notice the following:

- The Virtual Display window indicates that the display has turned on and selected Slot 1.
- The Virtual Theater Zone indicates the Integra has remained on the Aux Input (Source 7).
- The Virtual S86 Theater Zone indicates the S86 Theater zone has remained On and selected Source 4.
- The interface changes to provide the controls configured in previous lessons for the SAT TV source.
- The zone's active source icon and name in the lower left has changed to reflect the source selected in the zone.



- Click the **Gear Icon** in the upper right to access the settings interface for the Integra DTR-60.5. *The settings interface will open, providing access to Bass, Treble, and some listening mode functionality.*



- Click the **“Off”** button in the Viewer and select **Theater Off**. Notice that the S86 Theater zone **does not shut off**. This is to prevent an interruption in the case that the speaker outputs from the zone or an additional zone on the Integra are in use as well. You can set up an Event Map to turn off the S86 Theater zone when it is not in use by the Integra:

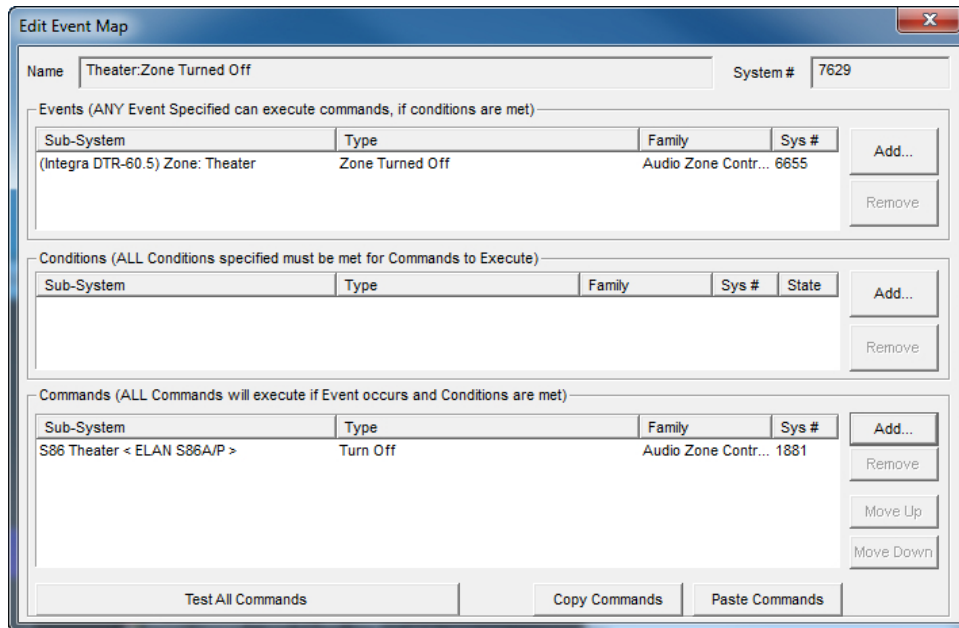

For more details, please see the Event Map lessons.

- When finished proceed to the next lesson.

Lesson 9

IR Control



Overview

In this lesson, you will:

- Learn about the built in IR outputs and IR input on the g! system controllers
- Learn how to build an IR Driver
 - Learn how IR Devices and IR Codes are organized in the configurator.
 - Learn how to import an IR file, ELAN IRF, HIR, or EIR, to build an IR Driver.
 - Learn how to use the IRL2 to learn IR codes directly into the g! software when building an IR Driver.
 - Learn how to check, test and optimize an IR device.
 - Understand Universal Functions and how they apply to IR devices and Interfaces.
 - Learn how to export and import IR Devices.
- Add IR Controlled Displays.
- Create and Customize Interface for IR Source
- Learn how to configure the built-in TV Channel Favorites interface.

Requirements

- A PC running g!Tools.
- ELAN Controller
- ELAN IRL2 (optional)
- IR Controlled TV and Source (optional)

Overview

Overview In previous lessons, you learned the basic steps for setting up an IR Controlled source and integrating it with the rest of the AV system. In this lesson, you will learn in detail all of the options available to build IR Drivers, called IR Devices, in the Configurator.

An IR Device is set up on the Input/Output tab of the Configurator and includes all of the IR Codes that are required to control the device. The IR code set that is added in the Input/Output tab is used as a code database by the rest of the system to control the device.

- IR controlled sources in the g! software require an IR Device and a customizable interface.
- IR controlled displays in the g! software require an IR Device and a customizable Generic Display.

IR Devices may also be used for control of unsupported zone controllers or non-AV equipment, though it is **strongly** recommended to use supported 2-way zone controllers. The g! software relies on feedback from the device to ensure the UI is in sync with the device, in the case of one-way IR Control the g! software has no way of knowing exactly what state the IR device is in.

In the following exercises, you will learn about IR Devices, IR Codes, and add IR controlled sources and displays to Configurator. You will also learn about importing and exporting your IR Devices and editing IR data.

Terms The following terms are used in the Configurator:

- **IR Device:** The IR device contains all pertinent information for a device being controlled by IR. This includes settings such as toggle bits and all IR codes.
- **IR Code:** The container for the specific hex (CCF) code that is sent to issue a command via IR. IR Codes also contain settings for the number of repeats and Universal Function, and information on the carrier frequency of the code.
- **Default Code Set:** The “template” of code blanks to use as a starting point when learning IR codes. Default code sets contain a list of codes with appropriate Universal Functions for you to learn codes into.
- **IR Sender:** The physical port to which an IR emitter is connected.
- **Default Sender:** The IR sender from which commands intended for a particular device should be sent.
- **Interface:** The customizable button layout that makes up the user interface in the Viewer to issue IR commands to the IR controlled devices.
- **Control:** A control is an object such as a button or group of buttons that can be added or removed in the user interface.
- **Universal Function:** A pointer used to map controls on an interface to their associated commands in the IR device.

How-to

To integrate an IR Controlled Device with the g! software:

1. Add the IR Device and configure its settings such as repeat count and the IR sender # to which the emitter is connected.
2. Learn or import the IR codes for the device
 - IR Codes can be learned directly into the g! software using the ELAN IRL2 learning tool
 - IR Codes may be imported from:
 - The IR library in g!Tools
 - ELAN IRF format files
 - ELAN (HomeLogic) HIR files
 - ELAN EIR files
3. Optimize and test IR Codes
4. Backup (export) the IR Device (if desired)
5. For sources:
 - Add the Interface
 - Customize the Interface (as needed)
 - Configure the Zone Controller for the sources and interfaces (See the lessons on Distributed AV and Home Theater for details)
6. For Displays:
 - Add a Generic Video Display
 - Map IR commands to display
 - Add the Display to a zone on the Zone Controller (See the lessons on Distributed AV and Home Theater for details)

Exercise 1: Built-in IR Control on the g! System Controllers

Overview The g!SC controller's include built-in and pre-configured IR output ports. The g1 system controller includes built-in and preconfigured IR output ports and an IR input port. In the following exercise, you will navigate through the Configurator to see how the g! system controller's built in IR input and outputs are organized in the software.

How-to

1. In the Configurator, navigate to the **Input/Output** tab.
2. In the system node tree click on **IR Outputs> IR Output 01**.

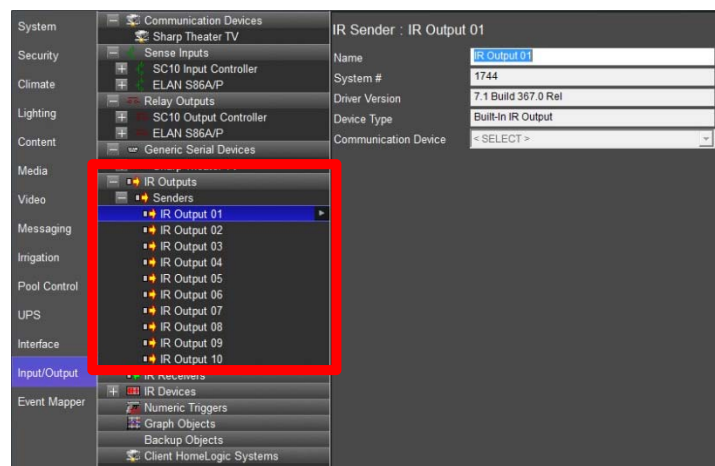

On the above screen (gSC controllers) note all 10 IR Output ports are pre-configured in the tree. These IR Outputs may be renamed by editing the name field but they cannot be deleted. All IR Outputs 1-10 are associated directly with the IR Output jacks on the back of the g! System Controller.

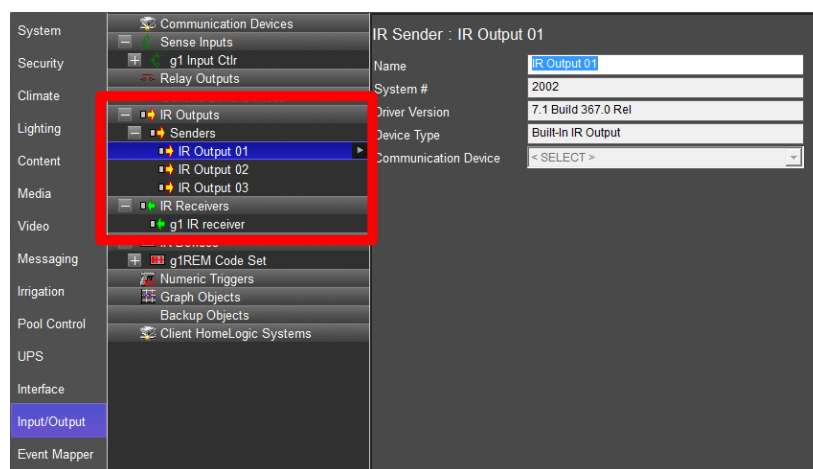

On the above screen (g1 controller) note all 3 IR Output ports and the IR Input port are pre-configured in the tree. The IR Outputs and IR Input may be renamed by editing the name field but they cannot be deleted.

3. In the system node tree right click on **IR Receivers**, and select **Add New IR Receiver**. *The Add New IR Receiver window appears.*

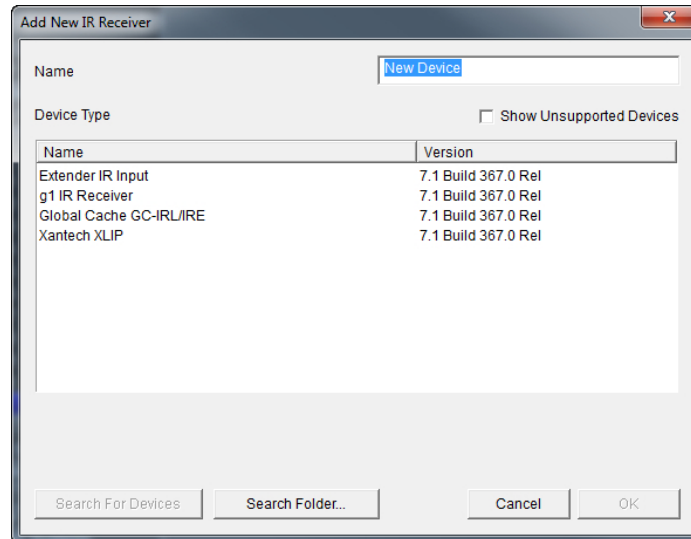

The above screen allows gSC controllers to add compatible IR Receivers to the system. IR Receivers allow the g system to be configured to respond when IR commands are received from an IR remote control. When using a g1 in Extender mode with a gSC controller this screen allows you to add and assign the g1's IR receiver for use in the system. You can rename the IR input by editing the name field. The g1 IR Receiver is associated directly with the IR IN jack on the back of the g1 Controller.

Important Note: The g1 IR Receiver is already added to the IR Receivers node when using a g1 as a system controller.

Exercise 2: Overview - IR Devices and IR Codes

Overview In Exercise 2, you will learn about IR Devices in the g! software. The IR device is the piece in the software that contains all of the data necessary to re-create and send IR out of the controller. It also includes information that allows the software to automatically link the various IR codes to buttons on a user interface.

In this exercise, you will review all of the various settings and options for the IR Device using the Built-in OSD IR Device: g1REM Code Set. This is the IR device built into the g1 Controllers to run the On Screen Display.

How-to The IR Device includes all the pertinent details for the device being controlled. This includes settings such as the emitter port number on a g! System Controller, repeat counts, toggle bits (if needed), and the IR Codes themselves.

1. In the Configurator, navigate to the **Input/Output** tab.
2. Navigate to and click on the **g1REM Code Set** under the **IR Devices** heading in the system node tree. *The window on the right shows all of the information pertinent to the OSD IR Device: g1REM Code Set.*

IR Device : g1REM Code Set	
Name	g1REM Code Set
System #	1655
Default Sender	< SELECT >
RC5 Codeset	No
Decode IR from this device	Yes
Tuning Type	Cable (Type 1)
Minimum Digits (0 Padding)	0
Pre-Tune Command	< NONE >
Post-Tune Command	< NONE >
Delay Between Commands	250 msec

The reference table below explains each of the items in the window shown on the previous page.

IR Device Reference:	
Name	Sets the name of the device. The name can be changed to reflect the devices location or for enumeration, for example "Satellite 1" or "Master Bedroom Cable Box"
System #	Unique, read-only number assigned by the g! software for internal use.
Default Sender	Drop-down field used to assign the controller IR output for the source device. This is the IR Jack on the back of the controller to which the emitter is connected.
RC5 Codeset	Also known as a toggle bit. This field is used to turn IR Toggle bits on or off. Default value is No . Some Phillips remotes use this format.
Decode IR from this Device	Set to "Yes" if there is an IR Receiver in a zone and the system should watch for incoming codes from this device for triggering event maps or universal functions. Default is No .
Tuning Type	For use with TV Channel Favorites. Drop-down field used to differentiate between devices with different channel assignments. Available options are Antenna, Cable (Type 1), Cable (Type 2), Satellite (Type 1) and Satellite (Type 2). Note that these type names are arbitrary assignments, and the names are provided for reference only. A Satellite box will still perform as expected if the Tuning Type set to Antenna. Default is Cable (Type 1).
Minimum Digits (0 Padding)	For use with TV Channel Favorites. Drop-down to select the minimum number of digits the device will accept as a channel number. If this is set to "3" and a single digit is entered for the TV Channel Favorite, the system will "Pad" the command by adding two "0" characters at the beginning of the IR stream. Default is "0"
Pre-Tune Command	For use with TV Channel Favorites. Use this drop-down to select a command to send before Direct Tuning. Default is < NONE >
Post-Tune Command	For use with TV Channel Favorites. Use this drop-down to select a command to send after Direct Tuning. Default is < NONE >
Delay Between Commands	For use with TV Channel Favorites. Set this value to the desired interval between Direct Tuning commands. Default is 250 msec .

Note: The OSD IR device is a special IR device. It is populated with the IR Codes from the IR Remote that controls the OSD. The controller needs to know about the IR from the remote to respond to incoming codes, and in turn, drive the On Screen Display.

In this case, the setting for “Default Sender” should be left as **<SELECT>** because these IR codes will never need to be sent. Also, the setting for “Decode IR from this Device” is **Yes**. This indicates that the controller needs to check all incoming IR data against these codes. If the controller recognizes an incoming IR code as an OSD code, it can respond appropriately and issue the associated OSD command.

3. Right-Click the IR Device **g1REM Code Set** to bring up the OSD options menu.

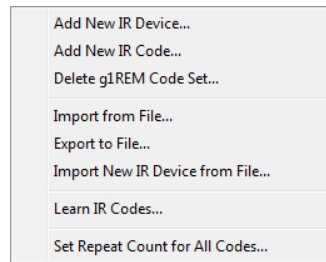

The reference table details each of the options shown in the screen above. These topics will be covered in detail in later exercises.

IR Device options:	
Add New IR Device	Adds a new IR Device to the system configuration. A dialog box opens that allows you to name and choose an IR Device Template.
Add New IR Code	Adds a new IR code node to the IR device. A dialog box opens that allows you to name and add the new IR code to the IR device.
Delete...	Deletes the highlighted IR Device.
Import From File	Imports IR data into the system for the highlighted IR Device. A dialog box opens that allows you to browse the IR Database within g!Tools.
Export to File	Export IR data from the system for the highlighted IR Device. A dialog box opens and you can select where to save the ELAN .EIR file.

Import New IR Device from File	Adds a new IR device node in IR Devices and imports the IR data. A dialog box opens and you can select the new IR Device file type .EIR, .HIR, or .IRF to add to the system.
Learn IR Codes	Activates the learning function for all of the codes within the IR device. Note that IR codes can also be learned individually, see below.
Set Repeat Count for All codes	Edits the repeat counts for every code within the IR device. Note that the IR codes can also be edited individually, see below.

- Click the “+” sign to the left of the device to expand the list of IR Commands, then click on the POWER command to review the information and settings pertinent to an IR code in the g! software.

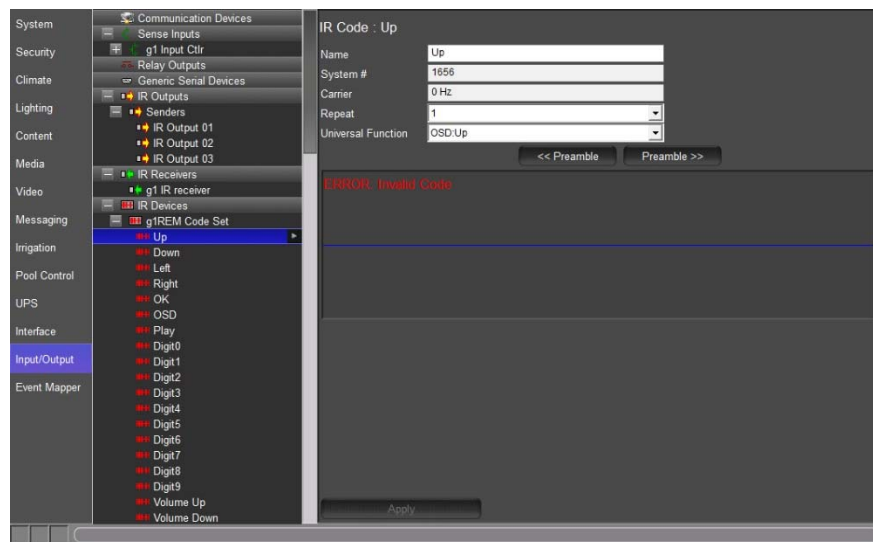

IR Code Reference:	
Name	Sets the name of the IR Code.
System #	Unique, read-only number assigned by the g! software for internal use.
Carrier	Read-Only field displays the frequency of the IR Code
Repeat	Drop-down selects the number of times the code is repeated for a single button press. All of the Repeat counts for a device can be changed by right-clicking the IR Device and selecting Set Repeat Count for All Codes. In the g! software the Default value is 1.
Universal Function	The universal function is the pointer for mapping the IR code to controls in an interface.
CCF Code (Button)	Click this button to open a dialog box to enter HEX CCF IR values
<<Preamble (Button)	Click this button to adjust the preamble selection of the IR Code to the left. This topic will be covered in detail in a later exercise within this lesson.
>>Preamble (Button)	Click this button to adjust the preamble selection of the IR Code to the right. This topic will be covered in detail in a later exercise within this lesson.
Time: (in the waveform window)	This is the total length of the IR code in milliseconds.

5. Right-click the **POWER** command to bring up the IR Code Options Menu.

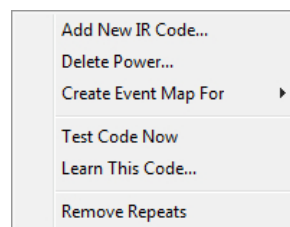

IR Code Options:	
Add New IR Code	Adds a new IR Code to the IR Device in the system configuration. A dialog box opens that allows you to set the new IR Code Name.
Delete ...	Select this option to delete the highlighted IR Code.

Create Event Map for >	Creates an Event Map for when the controller receives this IR Code. A dialog box opens that allows you to name the new Event Map and define the behavior of the Event Map.
Test Code Now	Sends the selected IR Code out of the default IR port as set on the IR Device. This is typically used for testing and verification of the IR data.
Learn This Code	Activates the learning function for the Highlighted IR code. (Note that all IR codes within an IR Device can also be learned in one automated step as described in this lesson).
Remove Repeats	Runs the g! software repeat filter on the highlighted IR Code. The software will analyze the IR Code and remove any erroneous repeats.

Exercise 3: Add an IR Device and Import an ELAN EIR file from g!Tools

Overview **g!Tools** includes an IR database that can be imported directly into the g! Software. (ELAN .EIR, .HIR, & .IRF files saved from other projects can also be imported). Importing files from g!Tools is an alternative to learning codes manually.

Note: When using .IRF files, it is important to pay close attention to the Universal Functions in the commands. The g! software tries to choose the Universal Function based on code names.

In this exercise, you will create a new IR device for a Video Display, import the codes from an .EIR file, and then check the codes. In addition, this exercise explains how to copy in raw CCF (hex) for IR codes that might be missing from the imported file. Sources for these CCF codes include manufacturer documentation, online resources like remotecentral.com, or third-party universal remote programming software.

How-to

1. Navigate to the **Input/Output** tab in the Configurator.
2. Right-click **IR Devices** in the System Node Tree and select **Import New IR Device from File**. *The Windows File Open window opens in the IRLibrary folder of g!Tools.*
3. Navigate to **LG->TV** and select **Code Group 1_OOR.EIR**:

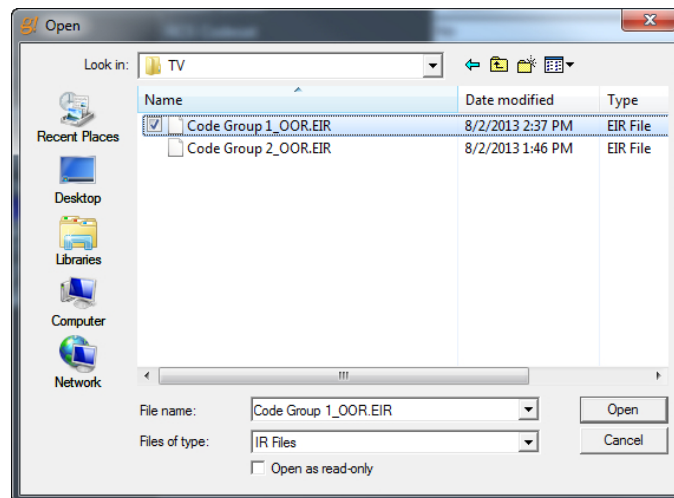

4. Click **Open**. *After a moment, the Configurator refreshes, and the imported codes are shown under LG TV Code Group 1:*

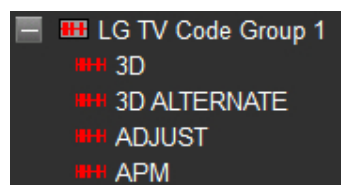

- Select the **LG TV Code Group 1** node to display the newly added IR device's properties in the Properties Pane to the right.

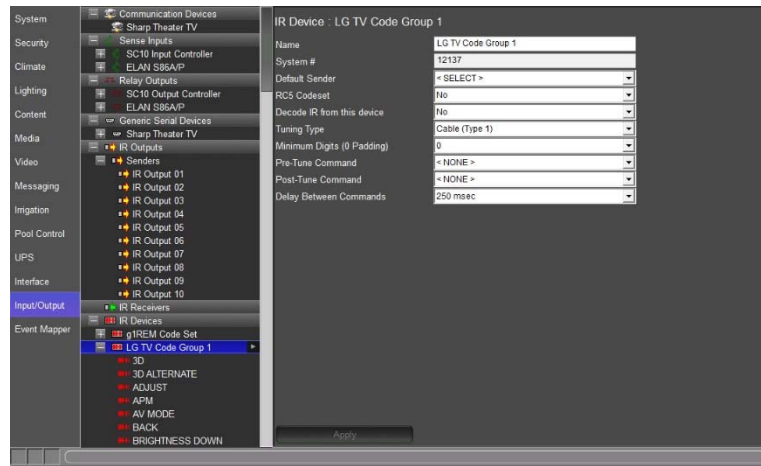

- Change the newly added IR device name to **IR Display** in the **Name** field, and click **Apply**. *The new IR Device's name will change to **IR Display** in the system node tree.*

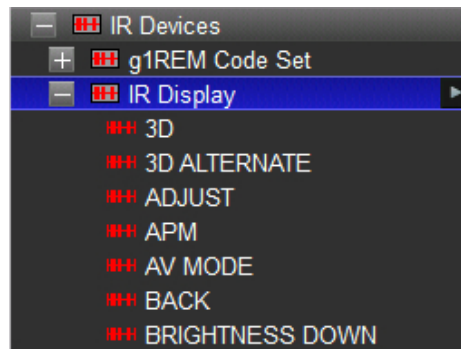

- Use the **Default Sender** drop down to select the **IR Output** that the IR device will be physically connected to. Select **IR Output 5** and then click **Apply**. Notice that IR Output 5 becomes highlighted in the system node tree to indicate the association.

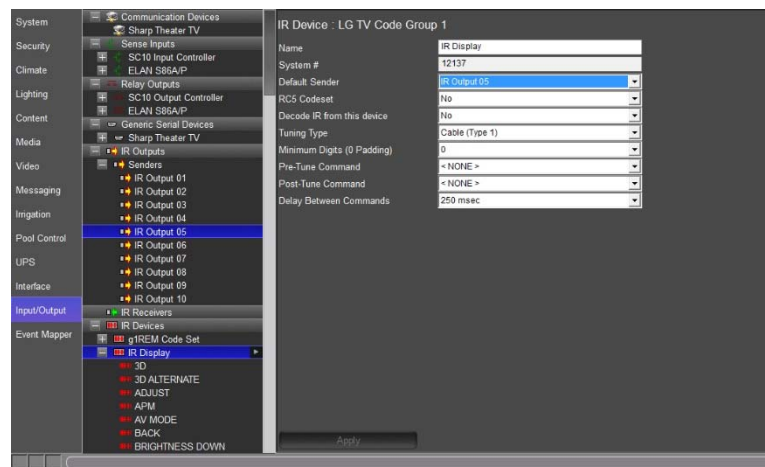

Notice that the list of imported IR Codes includes many discrete Commands. If there are any additional IR commands needed they can be added using CCF data. In the following steps we will add discrete Component 1 & 2 input commands using CCF data.

8. To add a new command:
 - a. Right-click any of the existing commands and select **Add New IR Code...** *The Add New IR Code window opens.*

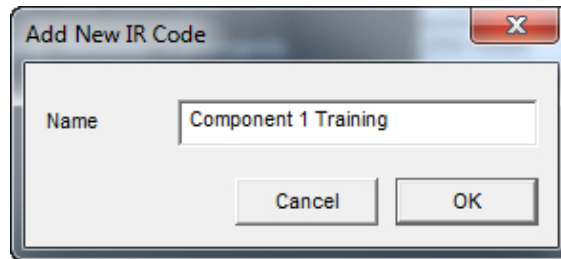

- b. Name the new IR Code "**Component 1 Training**", and click **OK**.
 - c. Set the **Universal Function** for the new command to **Source Component 1** and click **Apply**.
 - d. Repeat steps **a**, **b** and **c** to add a '**Component 2**' Command.

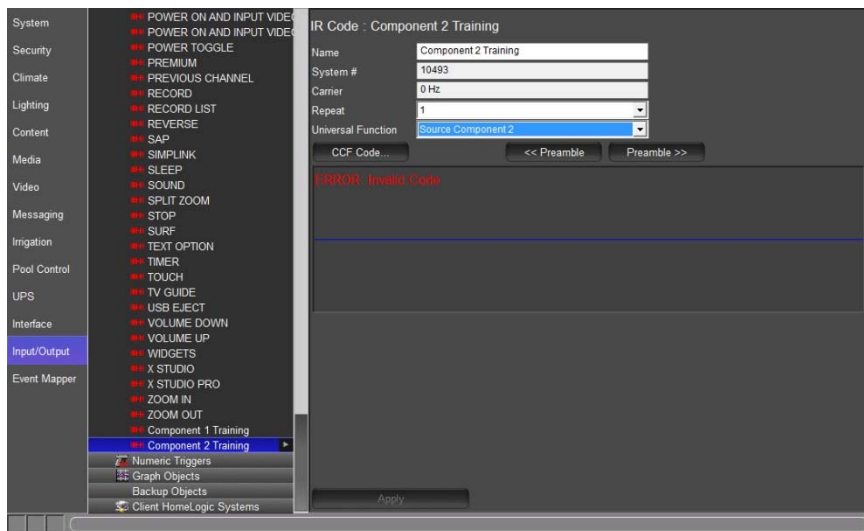

- e. Using Windows Explorer, navigate to C:\HomeLogic\Training Files and open the **Component 1.txt** file in Notepad.

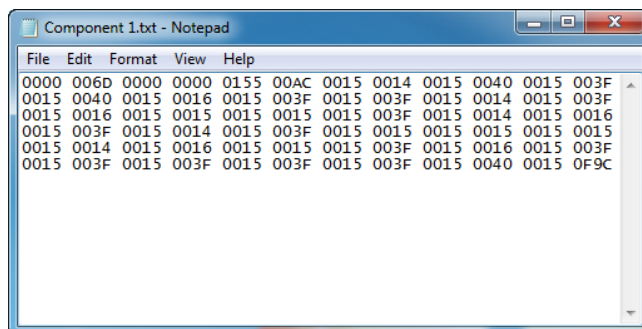

- f. Select **Edit>Select All**. *All of the text in the document will be highlighted.*
- g. Select **Edit>Copy** to copy the selected text to the Windows Clipboard:

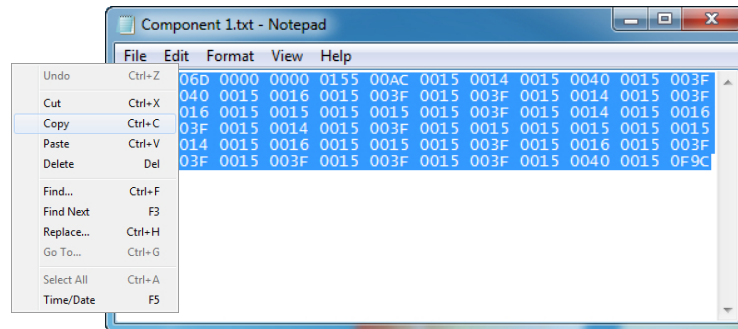

- h. Close Notepad.
- i. Return to the Configurator and select the **Component 1** command from the **IR Display Device**.
- j. Click the **CCF Code** button. *The Edit CCF String window opens.*
- k. Right-click inside the Edit CCF String box and select **Paste**. *The text from the Windows Clipboard is pasted into the box:*

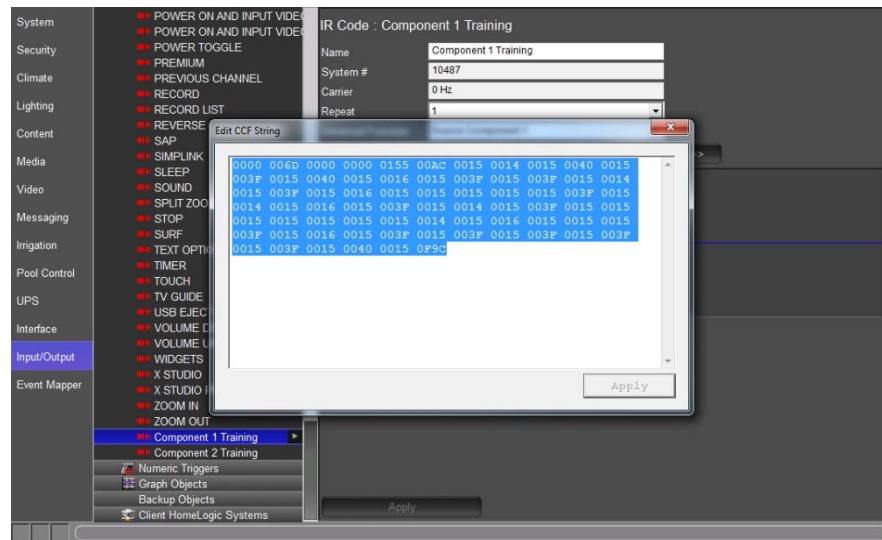

- l. Click **Apply**. *The Waveform View will be generated from the CCF Code*
- m. Click the **X** to close the Edit CCF String window.
- n. Repeat steps above to copy and paste the CCF for the **Component 2** command.

9. After all the codes are added and their IR Output assigned, test them using the Test Code Now option. From the Input/Output tab, right-click the code and select **Test Code Now**.

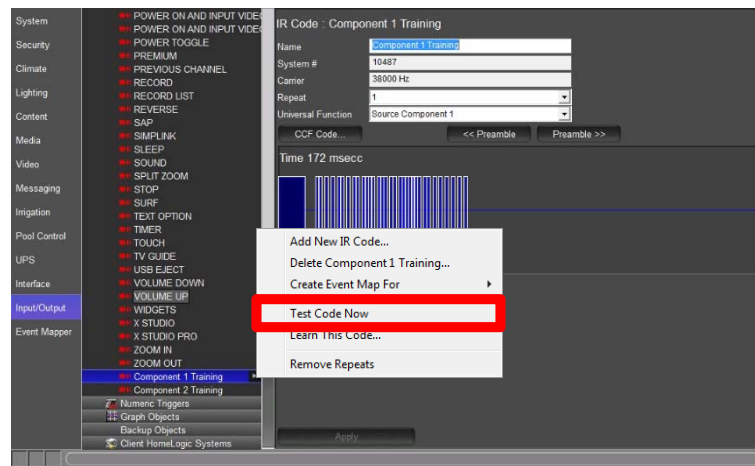

Note: Since the actual equipment is not installed for this lesson, we do not know if the command is effective; however, we will assume it is valid. On a real installation, testing codes can be very helpful, and is an important part of the driver creation process.

After you have verified that the imported codes work, it is a good idea to prepare them for use in an interface by checking Universal Functions. Since these files were imported from the ELAN database, they do not natively save Universal Function information.

The g! software attempts to match up Universal Functions for you automatically, but if the names of the codes do not match a Universal Function, they will not auto map. Therefore, it is important to **verify that all imported codes have Universal Functions set correctly** after importing them from the ELAN EIR/IRF/HIR file.

11. Check Universal Functions as follows:

- a. Click on the **Input Video 1** command. Since the g! software's equivalent Universal Function is labeled **Source Video 1**, this code does not align with any Universal Functions.
- b. Set the correct Universal Function now by clicking on the **Universal Function** drop down, scrolling down and selecting **Source Video 1**, and click **Apply**.

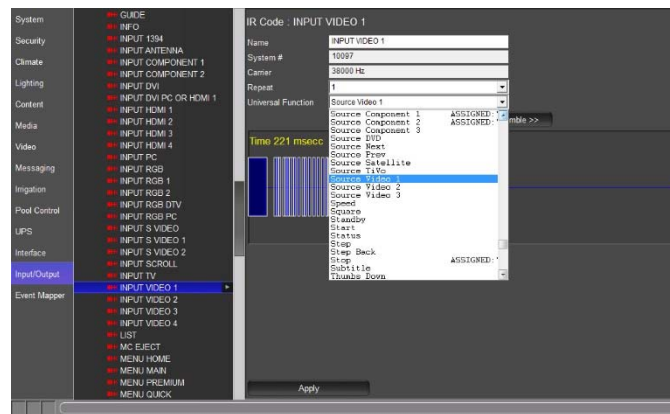

- c. Repeat for all the codes selecting the Universal Function as necessary.

Once the data has been mapped and tested, we recommend that you save it for future use. Refer to Exercise 6 for instructions on how to export an IR device.

Exercise 4: Add an IR Device and Learn Codes Using the ELAN IRL2

Overview The ELAN IRL2 Learner tool learns IR codes directly into the g! software from an OEM or universal IR remote control. The IRL2 connects to a USB port on the programmers' PC and it is used with the Configurator to learn IR codes into an IR Device.

In Exercise 4, you will add a new IR device for a Satellite Box and use the built-in g! IR learning functionality to assign IR codes for each function.

If you do not have a IRL2 and a remote, you cannot perform all the steps in this exercise. However, it is helpful to read through these steps to understand the process. All steps, minus the actual code learning, are possible without this equipment.

How-to

Step 1: Add an IR Device.

The IR Device includes all the pertinent details for the controlled device, as well as settings for the emitter port on the g! System Controller, repeat counts, toggle bits (if needed), and the IR Codes themselves.

1. In the Configurator, go to the **Input/Output** tab
2. Right-click the **IR Devices** heading in the system node tree and select **Add New IR Device...** The *Add New IR Device Window* will open.
 - a. Select **DirecTV** from the list of **Default Code Sets**. The Default Code Set will pre-populate a list of code blanks into which the actual IR is learned.
 - b. Change the **Device Name** to "**Satellite**":

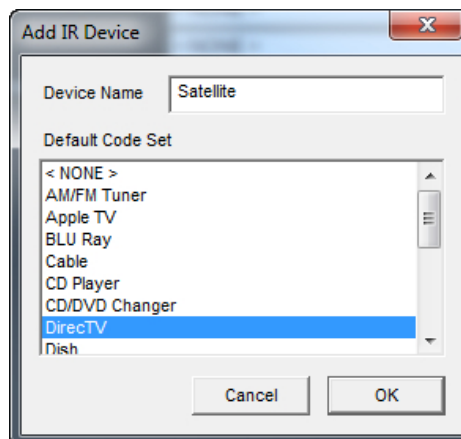

- c. Click **OK**. A new IR Device named "Satellite" is added.

IR Device : New IR Device	
Name	Satellite
System #	7207
Default Sender	< SELECT >
RC5 Codeset	No
Decode IR from this device	No
Tuning Type	Cable (Type 1)
Minimum Digits (0 Padding)	0
Pre-Tune Command	< NONE >
Post-Tune Command	< NONE >
Delay Between Commands	250 msec

- In the properties window of the Satellite IR device, select **IR Output 6** as the **Default Sender** for this IR Device.
- Click **Apply**. This tells the controller that the emitter for the satellite is connected to IR Output 6 on the back of the g! system controller.
- Click the “+” sign to the left of the device to expand the list of IR Commands. *The Placeholders for commands for a typical IR controlled Satellite box are shown:*

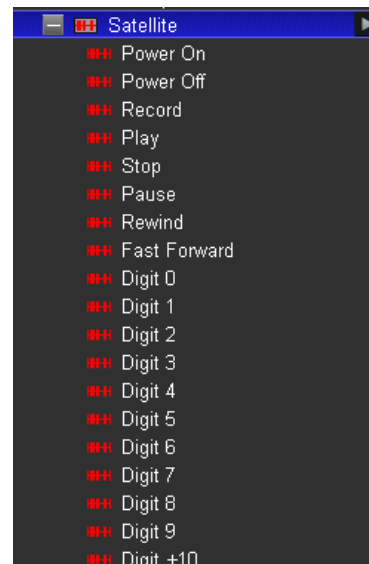

Note: In a real installation, this would be a good time to look through the codes listed in the Default Code Set and compare them to the functions on the remote. If you wish to add commands that aren't already populated, it may be easier to add them now and learn them in all at once, rather than learn the additional commands individually later.

For details on adding commands, see **Step 3** below.

Step 2: Learn IR Codes.

The next step in creating an IR Device is to learn the actual IR codes into the code blanks using the IRL2. If you do not have an IRL2 and remote, then follow these steps for reference only.

1. Attach the IRL2 to a USB port on your PC. The red PWR light on the IRL2 lights up, indicating it is on.
2. Right-click the **Satellite** IR device and select **Learn IR Codes** from the menu. *The IR Learning window is displayed, with the words "Ready, Press Start to Begin" at the top:*

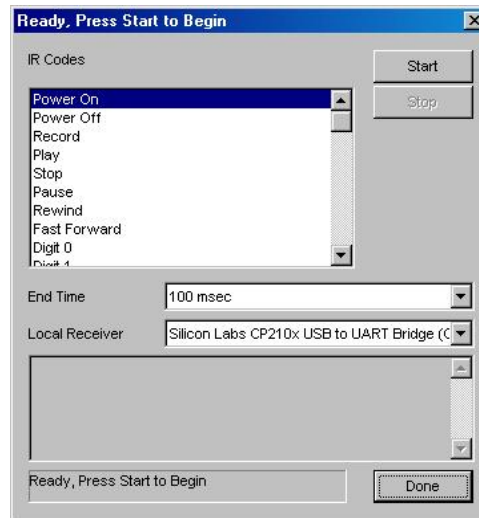

Note: By default, the **End Time** is set to **100 msec**. This value can be reduced to help capture codes from remotes with shorter pauses between repeated commands.

3. From the **Local Receiver** drop-down, select the **Silicon Labs CP210x USB to UART Bridge**. *This is the driver for the IRL2 learning device.*
4. Click **Start**. *The dialog changes to Learning Code Mode and prompts you for the code to learn in its Title Bar and Status window as shown.*

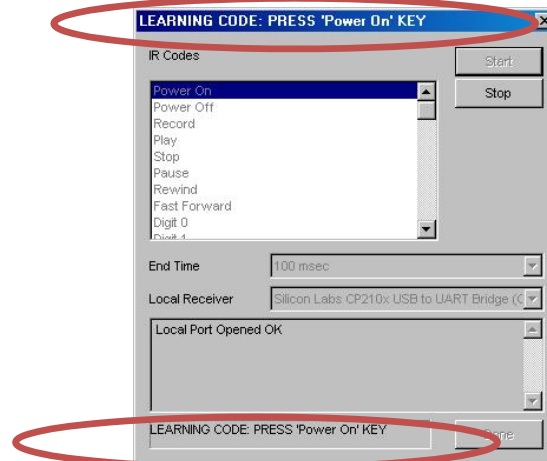

- Holding the remote 3-6" from the IRL2, point the remote control at the **IR IN Sensor** on the IRL2, then press the button that corresponds to the key referenced in the title bar and at the bottom of the learning window for two seconds, and release. *The IR IN Detect LED will blink on the IRL2 and the IR waveform will flash in the background of the Configurator as the code is learned.*

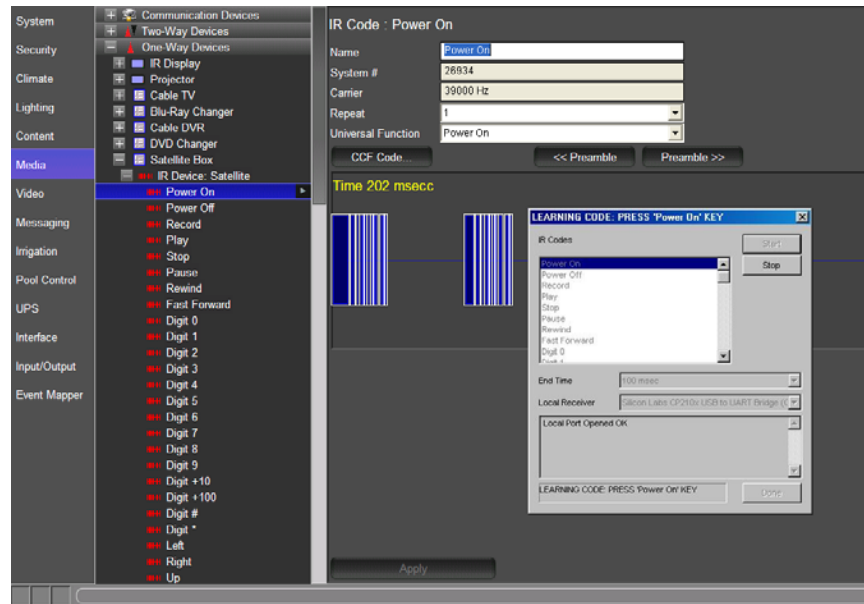

- When the code is received, the learning utility captures and processes the code, then automatically advances to the next code in the list. Be sure to wait to be prompted for the next code prior to pressing the next button. Continue until all codes are learned, and then click **Done**.

Note: If you make a mistake and learn a code into the wrong spot, you can go back and re-learn the individual codes one at a time. To do this, first complete learning the remaining codes in the list and click **Done**. Then, right-click the individual code in the system node tree and select **Learn this Code**.

Step 3: Add additional IR Codes.

During the process of learning all the codes contained in the Default Code Set for DirecTV, you may notice that some buttons on the remote were never asked for, and are not included in the Default Code Set. If there are codes you wish to use in the g! software that did not exist in the Default Code Set, you can add these codes manually.

In the following steps, you will add a new IR command and learn the code.

1. If the list of commands for the Satellite IR device is not already visible, click the “+” sign next to the IR device to expand it.
2. Right-click any existing command in the list and select **Add New IR Code...** from the pop-up menu. *The Add New IR Code dialog box will be displayed:*

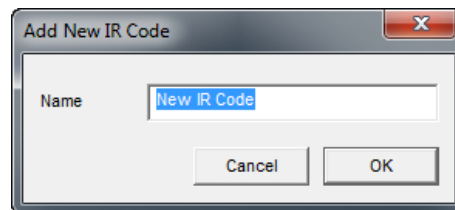

3. Enter a descriptive name for the new code and click **OK**. *The new command is added at the bottom of the list and its properties are displayed on the right.*
4. Right-click the **New IR Code** and select **Learn this Code...**
5. From the **Local Receiver** drop-down, select the **Silicon Labs USB to UART** driver for the IRL2.
6. Click **Start** then point the remote control at the IRL2 (at a **3-6 inch distance**) and press the appropriate button for two seconds.
7. After the code is received, click **Done**.

Exercise 5: Check and Optimize Codes

Overview The following steps explain how to verify the IR data and all settings relevant to IR codes in the g! software. These steps also include reference examples to demonstrate troubleshooting and how to work with bad IR codes.

How-to

1. IR Testing.

Testing an IR Code can be performed directly from the Configurator. It is important to test your codes after importing or learning them to ensure proper operation.

- a. Right-click the code you wish to send, and select **Test Code Now**. *The IR Code will be sent using the Default Sender port.*
- b. Verify that the device responds to the code properly and does not repeat the command.

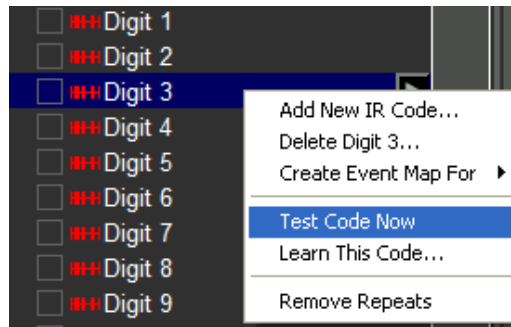

- c. If the command does not work then check the following:
 - If not already installed, try testing the code with a visibly flashing IR emitter plugged into the default sender port. When the code is sent the emitter should blink.
 - Verify the LED IR OUT blinks when the IR code is tested.
 - Verify the emitter is located appropriately on the IR sensor on the device to be controlled.
 - Try re-learning the IR code.

Note: It is good policy to test all IR codes learned into the system. See the steps below for details on spotting when the code itself is the problem.

The HR2 remote cannot be used to test codes. Use a standard sender temporarily to test codes instead.

2. Spotting and Fixing Bad IR Codes.

The following steps demonstrate what proper IR codes typically look like in the Configurator, and how to spot bad IR Codes.

Example 1: Proper IR Code Examples

The following images are some examples of the waveform view of proper IR codes. Note that there are many typical waveforms and not all proper waveforms are shown in these examples. In the examples, please note:

- The IR code time is typically *less than 200 msec*.
- The white outline on the IR codes indicates the part of the code that will be repeated by the g! software in the case of a button hold from a user interface or the OSD remote. In the first two images the entire waveform will be repeated. In the third image the entire code will be sent once then the smaller repeating section will be repeated.
- The first two images are basic code waveform examples. When these codes are sent from the g! software, the entire waveform will be repeated when the command button is pressed and held down.
- The third image is an example of an IR code that includes the basic waveform and a separate smaller waveform that is its repeating section. When this IR code is sent, the software will first send the entire code then continue to send the small repeating section until the command button is released.

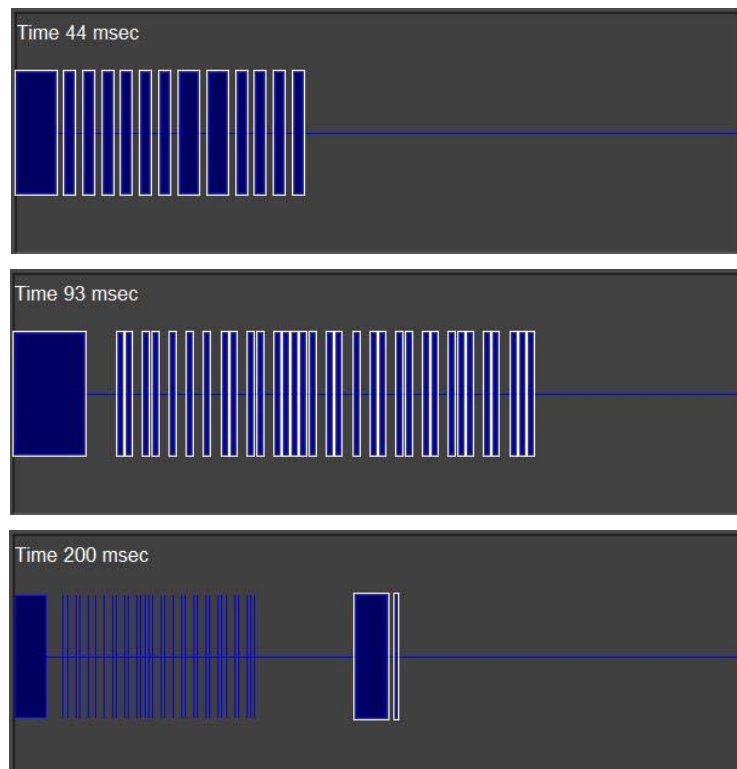

Example 2: Bad IR Code- Code repeated several times

How to spot: The following image is an example of a **bad** IR code. Note that the time is well over 200 msec, and the font color of the displayed time has turned yellow. In the first image below, the code itself is repeated multiple times. In the second image the repeating section has been captured multiple times.

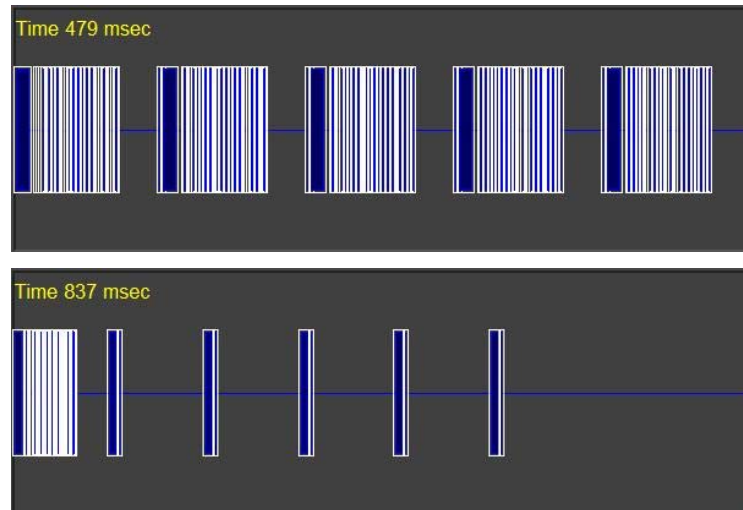

Why it happens: Codes like this can occur when the button is held too long when learning, or when the End Time on the Learn IR Codes window is set too high.

How to fix: The Configurator provides a built-in IR Code editor to fix codes such as this.

The large block at the beginning of the line is the actual code. The vertical line groupings after the first block are multiple repeating sections sent by the remote and erroneously learned by the software. To fix a code that looks like this, use the mouse to perform the following steps:

- a. Click the horizontal center line at the **far right** of the waveform.
- b. Continue to hold down the mouse button, and drag the mouse to the left. *The waveform will begin to highlight green:*

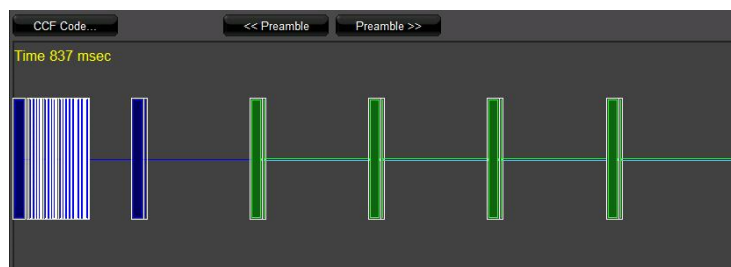

- c. Continue to highlight the waveform, **leaving the last repeating section and end pause unselected** as shown in the image above.
- d. Click the CCF Code button above the image. The CCF Code Window will open:

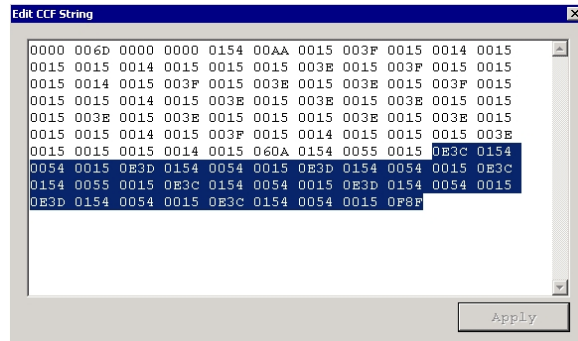

The highlighted text in the CCF code string corresponds to the highlighted portion of the waveform view.

- e. Press the **Delete** key on your keyboard, and then click **Apply**.
- f. Close the window and observe that section of the CCF Code was removed and the waveform is changed:

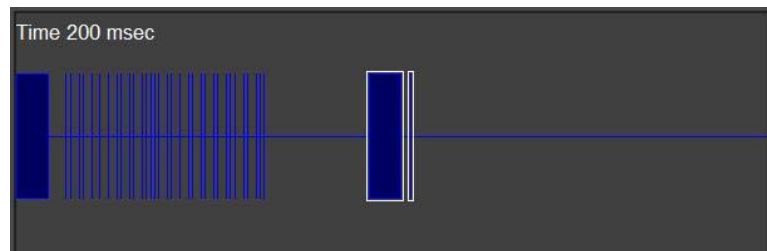

Note: If you cannot get codes to work after editing out suspected bad sections using the steps above, try re-learning the code.

3. Setting Universal Functions.

The g! software uses a concept called **Universal Functions** to help when mapping interface buttons to their respective commands. In the following steps, you will verify that all the Universal Functions are set correctly.

- Select the first command in the list. *The properties window for the IR Code is displayed on the right:*
- In the IR Code: properties window, select the appropriate item from the **Universal Function** drop-down, and then click **Apply**. If there is not a match for the code you are using you can either set it to <None> or you can assign it to one of the User functions.

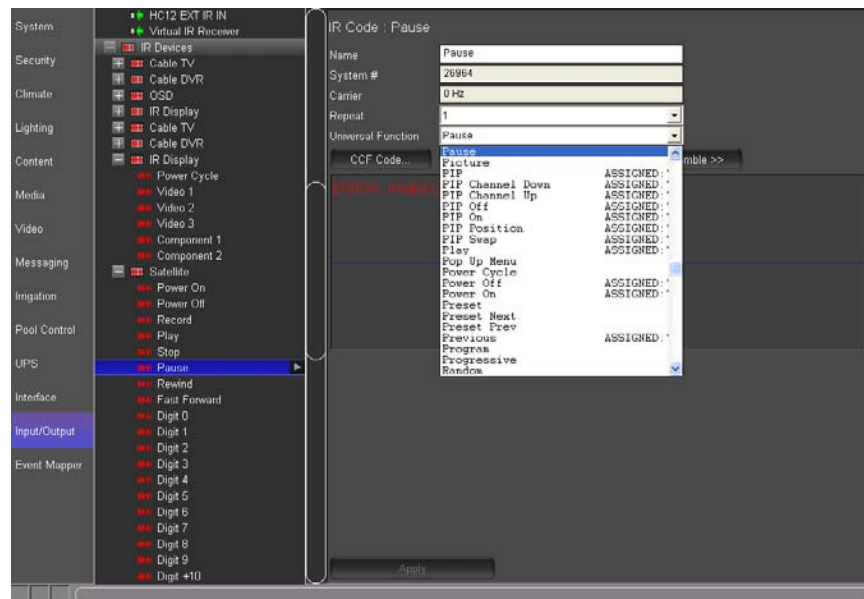

- Confirm that the Universal Function for the other codes are all set correctly to ensure proper mapping.

Notes:

- Codes added as part of a Default Code Set should already have proper mapping.
- The drop down list indicates which functions have already been mapped within the IR Device to help avoid setting duplicate functions.

4. Set proper Repeat Counts.

By default, all IR commands have their Repeat Count set to **1**, meaning the IR Code is sent once every time it is issued. In some cases it is desirable to increase this value to ensure that the IR Command is received successfully. However, if a repeating code causes undesired behavior when the IR code is sent (for example, sending the Channel Up command results in the channel incrementing more than once); you may need to decrease the Repeat Count for the code.

- Select the code in the Configurator.
- In the properties window for the selected code, change the selected number in the **Repeat** drop-down as needed and click **Apply**.

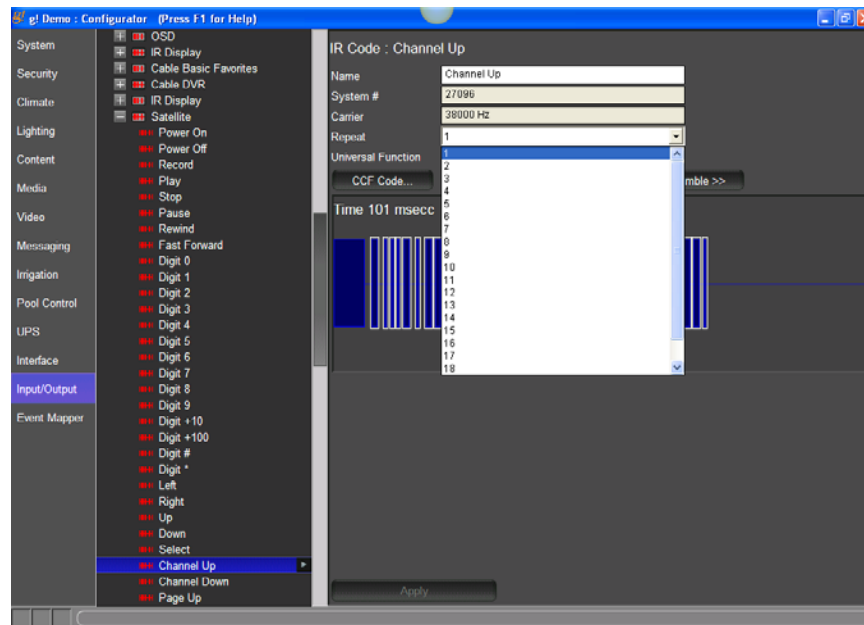

Note: You can change all of the Repeat Counts for an IR device at the same time by right-clicking the device and selecting Set Repeat Count for All Codes.

Add New IR Device...
 Add New IR Code...
 Delete Satellite...
 Import from File...
 Export to File...
 Import New IR Device from File...
 Learn IR Codes...
 Set Repeat Count for All Codes...

5. Check pre-amble setting for repeating IR

Setting the preamble and repeating section properly is necessary to define the portion of the IR code that is repeated when a control button is pressed and held on the user interface or remote. The repeating portion of an IR code is marked with a white outline around the wave form in the Configurator waveform view.

The following steps identify and set the proper preamble to allow the g! software to accurately reproduce the IR code.

- a. Determine whether the device uses a small repeating section or if it simply repeats the entire code. Previously in Step 2, Example 1, we learned how to identify which repeating section the device used. The sample below uses a small repeating section.
- b. The first image shows an IR code that includes a separate repeating section but the g! software is configured incorrectly, repeating the entire waveform. Use the Preamble adjustment buttons to move the white outline and edit the selected repeat area.
- c. The second image shows the proper repeat area selection after the correction was made.

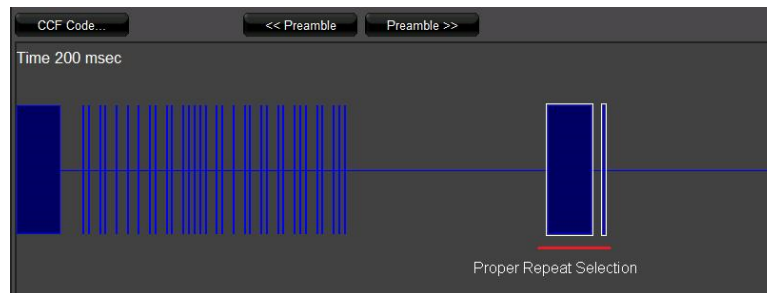

Exercise 6: Export an IR File

Overview Now that the IR Device has had all the codes tested and optimized, and all proper mapping completed, you can export a copy of the IR Device. The exported file can be re-imported into this system in case you are controlling multiple identical devices, or imported into another system if you are using this device in a future job. It is recommended that you export your files to an appropriate folder in the **g!Tools IR library** so that they will be easy to find when you need them.

How-to

1. In the Configurator, go to the **Input/Output** tab.
2. Right-click the desired device under IR Devices, then select **Export to File**. The **Export IR File** window opens. This window is used to save the new IRF file in the IR Library in g!Tools.

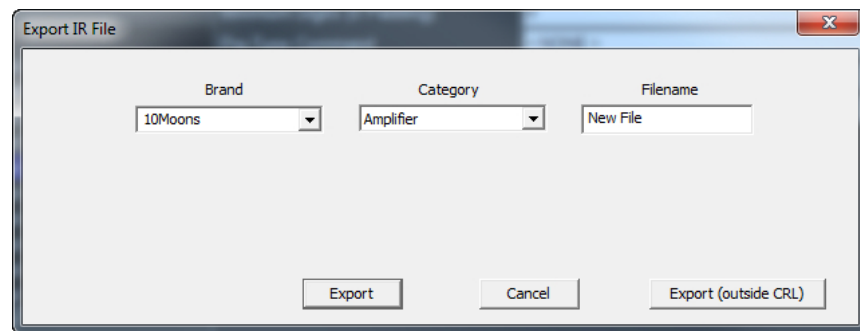

3. Select the Manufacturer from the Brand drop-down list, and then select the appropriate category from the Category drop-down list.

Note: g!Tools sometimes installs the data files into a hidden directory. You need to select “show hidden files and folders” from your explorer folder options dialog box to be able to browse directly to it. Alternatively, you can create a shortcut on your desktop to the directory to access the folders.

4. In the **Filename** field type a descriptive name for the IR device, such as the model number of the device.

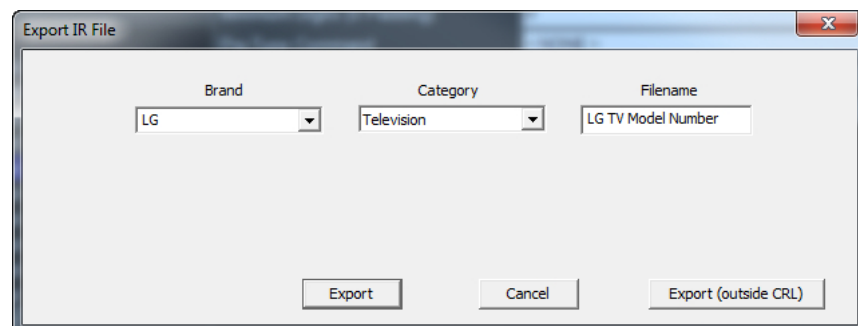

Once the IR device has been named click **Export**. The EIR file will be saved into g!Tools.

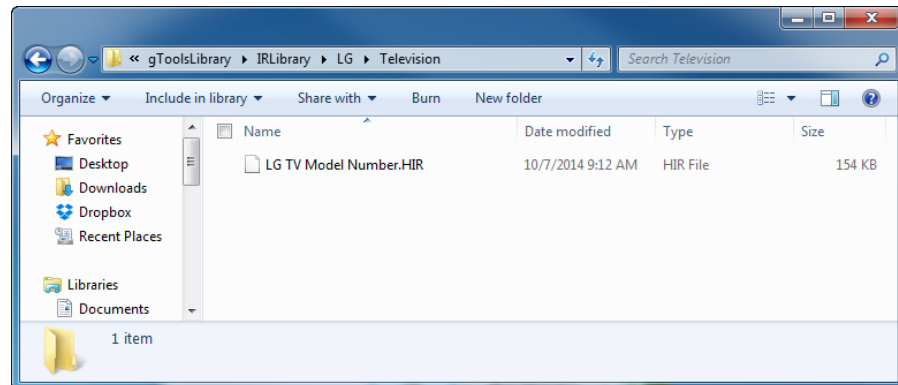

If you wish to save the file elsewhere, click the Export (outside CRL) button. The Windows Save As dialog box opens. Navigate to the desired location on your computer or network, and then click **Save**.

Note: Saved file names should be as descriptive as possible and include manufacturer, model number and device type so that they will be easy to find when you have many saved devices.

Exercise 7: Add an IR Controlled Display

Overview In a previous exercise, you added the IR Codes for controlling an IR Controlled Display. You will now add the Custom Video Display itself on the Media tab. The Custom Video Display is the item in the g! Configurator where you can define the display properties and settings so the g! software can know which IR codes are associated with the power states and inputs.

In this exercise, you will add an IR Controlled Display as a zone controller into the project, assign IR commands to the various functions, and add source devices to the IR video display.

How-to

1. Navigate to the **Media** tab in the Configurator, right-click **Video Displays** and select **Add New Video Display**. *The Add New Video Display Dialog box is shown:*

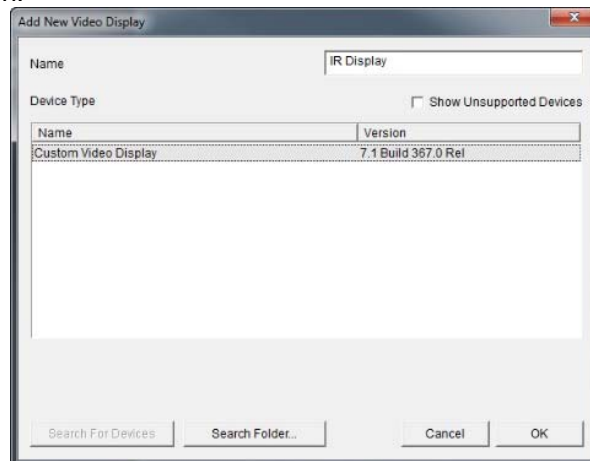

2. Name the device "**IR Display**", select **Custom Video Display** from the list, and click **OK**. *A New Video Display node will be added:*

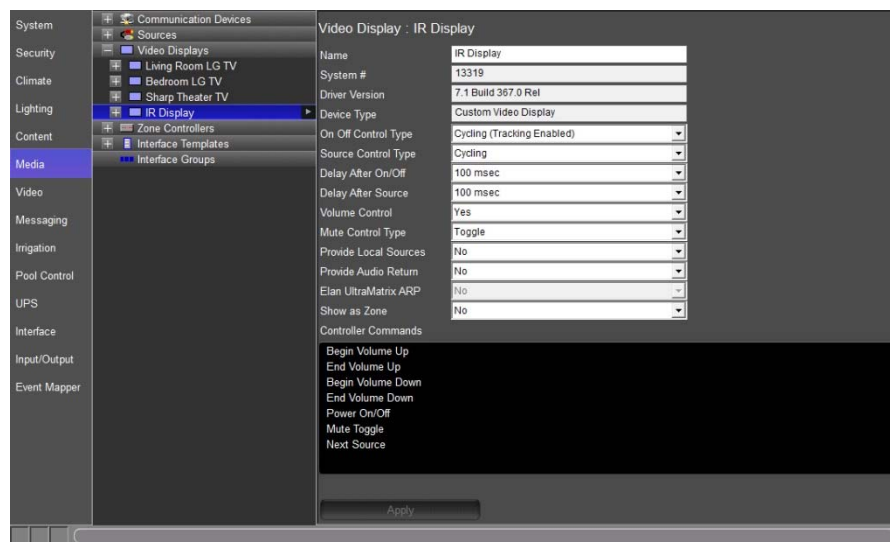

3. Check the **Settings** on the Display.
 - a. Set **On Off Control Type** to **Discrete**. *The Power Command in the Controller Commands Window will change from Power Cycle to separate commands for Power On and Power Off:*

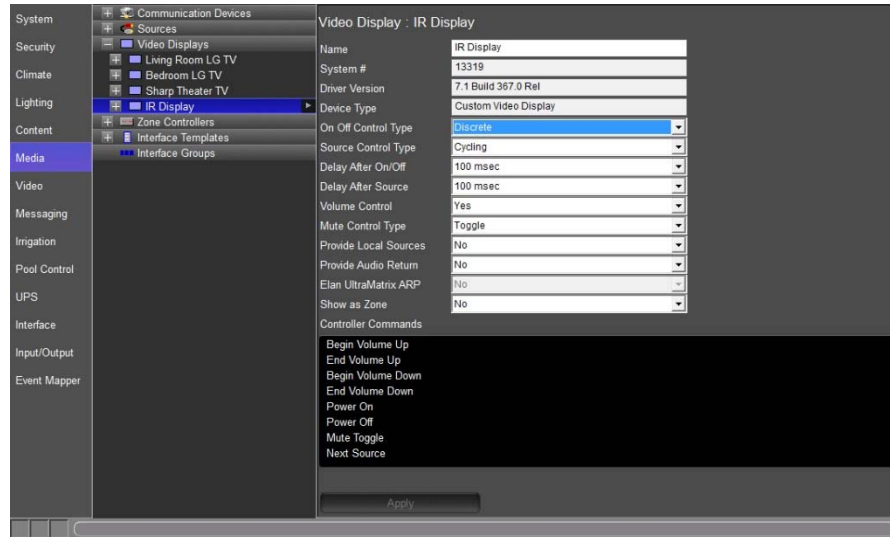

- b. Set **Source Control Type** to **Discrete Verify (Always Send)** then click **Apply**. *“Next Source” is replaced with (Source 1) in the Controller Commands area after Apply is selected.*

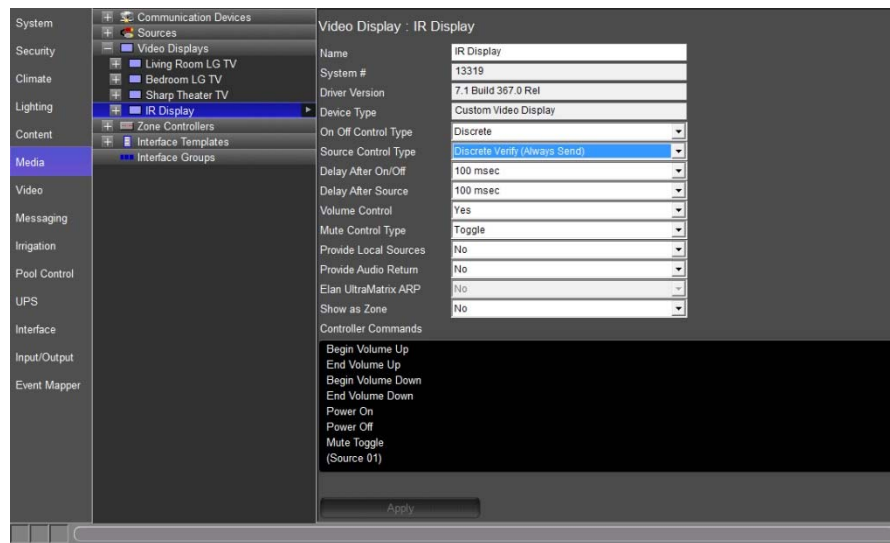

- c. Set the **Delay After On/Off** to the appropriate time to delay the source input command after a power command has been sent to the video display and click **Apply**. *Delay times may be set from 100 msec to 60 sec. Delay times will vary depending on the IR video display being used in the project.*

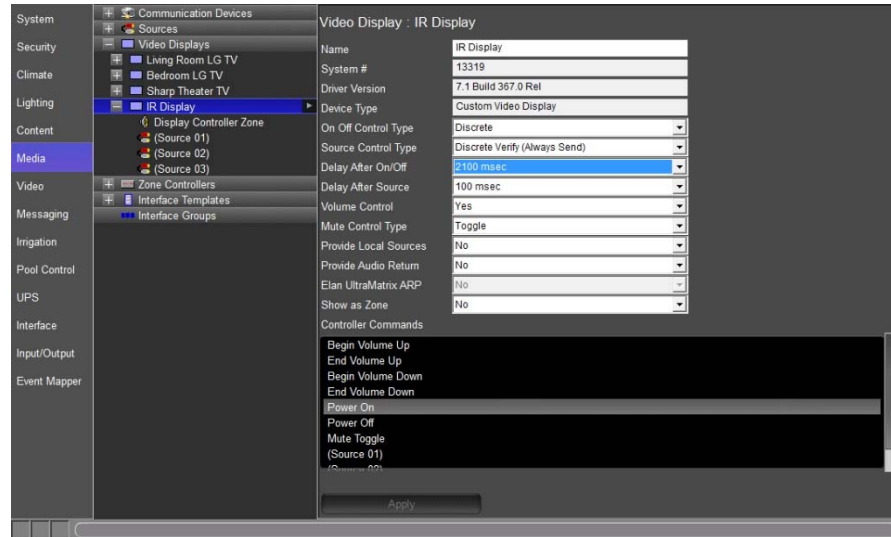

- d. Set the **Delay After Source** to the appropriate time to delay send the video display additional commands after the source input command has been sent to the video display and click **Apply**. *Delay times may be set from 100 msec to 14900 msec. Delay times will vary depending on the IR video display being used in the project.*

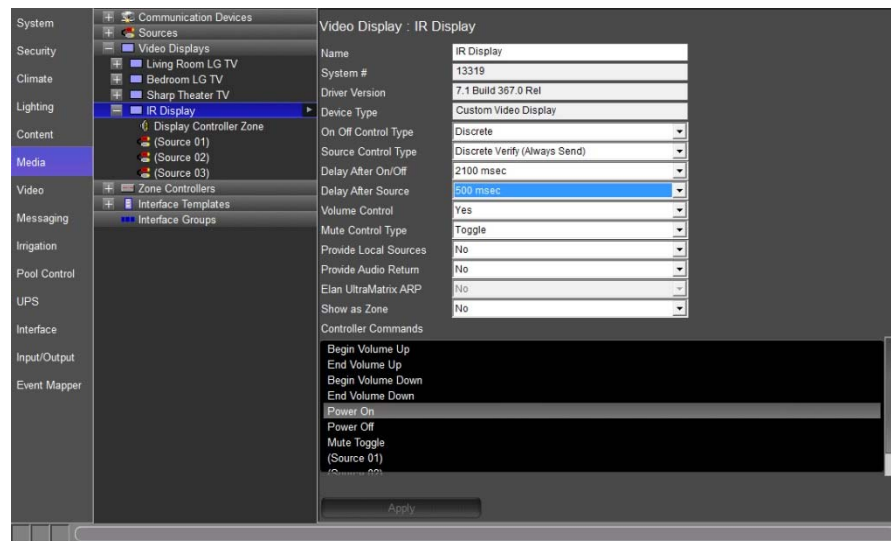

- e. Set the **Volume Control** drop-down to **Yes**.
- f. Set the Mute Control Type appropriately. For this exercise we will set the **Mute Control Type** to **Toggle**.

- g. The **Provide Local Sources** drop-down should be set to **No**. *In this exercise the video display zone will not be split with another zone controller (i.e. ELAN S86A/P) and therefore will not require independent volume control from the two zone controllers.*
- h. The **Provide Audio Return** drop-down should be set to **No**. *In this exercise the video display's audio output will not be connected to an audio input on a zone controller.*
- i. Set the **Show as Zone** drop-down to **Yes**. *This will now show the IR Display as a zone in the g Viewer.*
- j. When finished the IR Display Properties Pane should look similar to the image below:

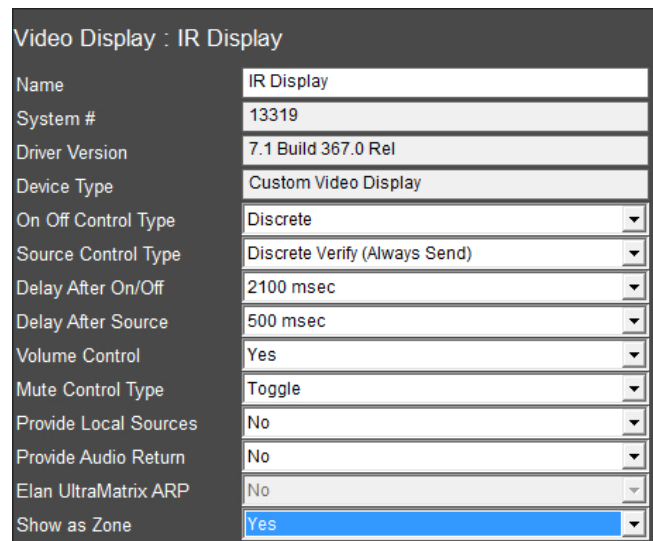

Quick Reference: Custom Video Display	
Name	Editable field used to name the video display.
System #	Unique, read-only number assigned by the g! software for internal use.
Driver Version	Core module rev the driver was last verified in.
On Off Control Type	How the display is turned on. Options are: Cycle (Tracking Enabled) – Uses the same command to turn the video display on and off. Tracking enabled allows g to track the On/Off status of the display. Cycle (Tracking Disabled) - Uses the same command to turn the video display on and off. Tracking disabled means g will not track the On/Off status of the video display. Discrete – The g system will send the power on or power off command when requested. Discrete Verify (Always Send) – The g system will send the power on or power off command every time a source associated to the video display is selected.

Source Control Type	<p>Cycle - Uses a single command to toggle between the available source inputs.</p> <p>Discrete – The g system will send the individual command for the specified source input.</p> <p>Discrete Verify (Always Send) – The g system will send the individual command for the specified source input every time a source is selected that is associated to an input on the video display.</p>
Delay After On/Off	The amount of time that has to expire before the video display can accept another command. Time setting is in milliseconds from 100 to 14900.
Delay After Source	The amount of time that has to expire before the video display can accept another command. Time setting is in milliseconds from 100 to 14900.
Volume Control	Allows the volume to be adjusted for the video display from a g User Interface.
Mute Control Type	<p>Sets how the video display will use the mute command.</p> <p>None – There is no mute command for the video display.</p> <p>Toggle – There is a single command for mute that toggles between mute on and mute off.</p> <p>Discrete – There is a separate mute on and separate mute off command for the video display that is managed by g.</p>
Provide Local Sources	Set to Yes when the area will be split between 2 zone controllers (i.e. an MRA & a Video Display) with independent volume control for both zone controllers.
Provide Audio Return	Set to Yes when connecting the audio output from a video display to an audio input on a zone controller (i.e. AVR, MRA, GSZC) in order to enable the Audio Return Input option in the zone node of a zone controller.
ELAN UltraMatrix ARP	Set to Yes if ARP (Audio Return Program) will be a source option for the ELAN gMV UltraMatrix. This option is greyed out if no gMV is being used in the system.
Show as Zone	Set to Yes to show the video display as an independent zone.
Controller Commands	Shows the available command names that are associated with the video display. Selecting a command name brings up the Command window for adding Serial or IR commands.

4. Click the **(+)** button to expand the IR Display node and select **(Source 1)**.
5. Name the source **Satellite** in the Display Name field and click **Apply**.

Audio Source:

System #

Source Device

Display Icon 

Source Volume

Display Name

6. Right-click on **(Source 1)** and select **Add New Source**. *The Add New Source Window appears.*

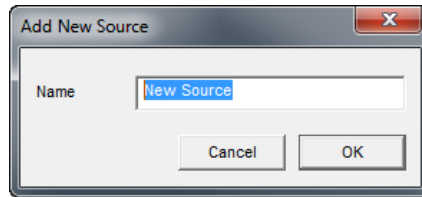

- a. Name the new input **"House SAT"**. *(Source 2) is added to the Controller Commands Box.*
- b. Verify the new input's display name was set to House SAT in the Display Name field.

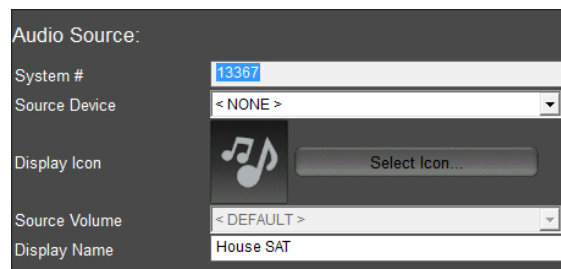

Note: As the new inputs are added the display name will differ from the name shown in the System Node Tree.

5. Click the **Begin Volume Up** controller command. *The Commands Window is displayed. Note that there is no command present for Begin Volume Up.*

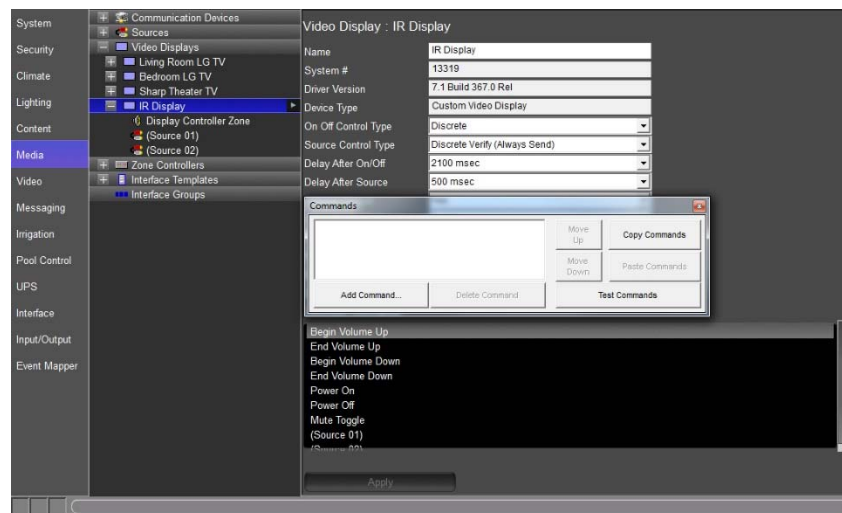

- a. Select the **Add Command** button in the Commands window. *The Add Command window appears.*

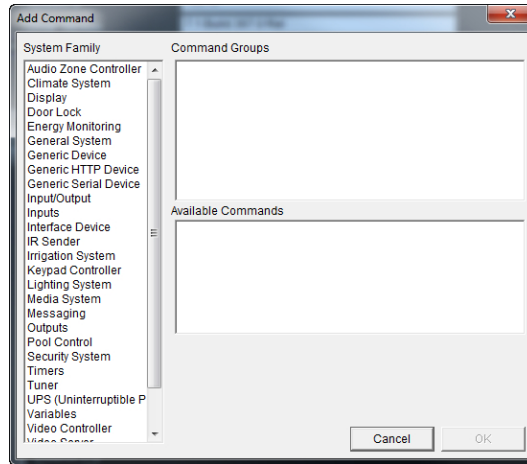

Quick Reference:	
System Family	A specific component of a system that is able to be used for creating events, conditions, and/or sending commands.
Command Groups	A part of the System Family that contains commands grouped together for easy access.
Available Commands	The commands that are available for the selected Command Group.
Options	Additional command options when Available Commands have multiple outcomes, such as routing a video input to a video output on a compatible video switcher.

- b. In the System Family column, select the **IR Sender** family. *Command Groups populates with the IR devices setup earlier.*
- c. In Command Groups locate and select **IR Display: VOLUME UP**. *The Available Commands box displays the command options for the selected Command Group.*
- d. In Available Commands select **Begin Repeating** and select **OK** when finished. *The Add Command window closes and the Commands window shows the newly added IR command.*

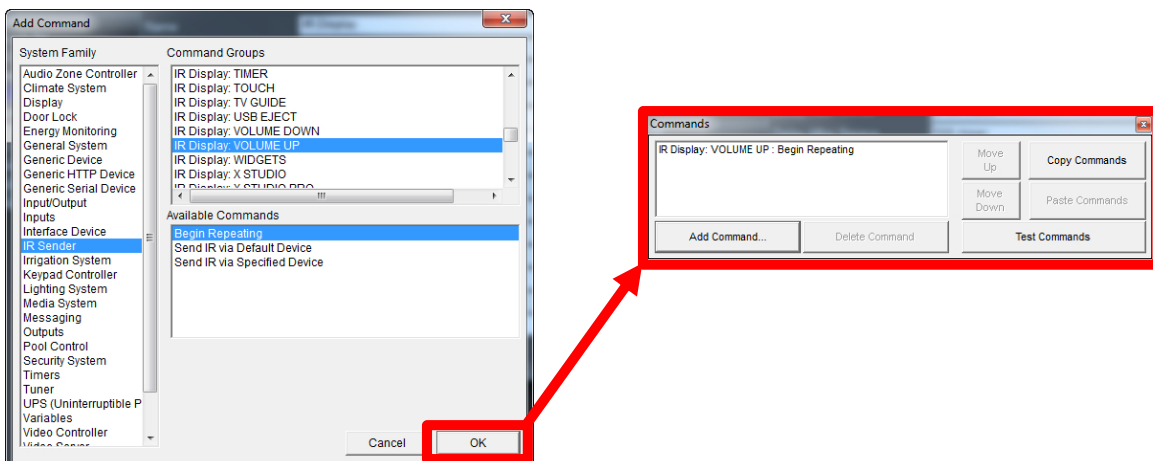

Note: When using Begin Repeating commands the IR command will be sent until a Stop Repeating command is sent.

- e. Select **End Volume Up**. *The Commands window is now blank.*

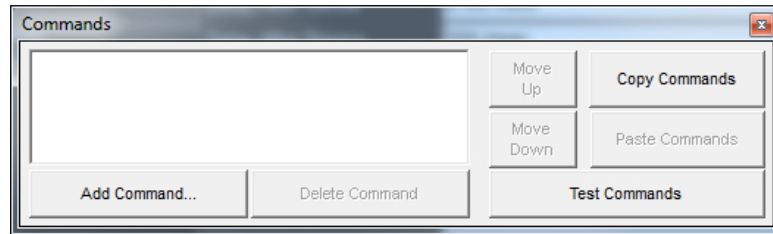

- f. Select **Add Command**. *The Add Command window appears.*
- g. In the System Family column, select the **IR Sender** family.
- h. In Command Groups locate and select **IR Display**.

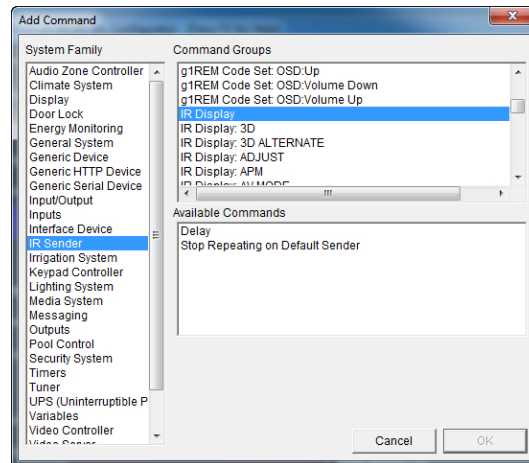

- i. In Available Commands select **Stop Repeating on Default Sender** and select **OK**.

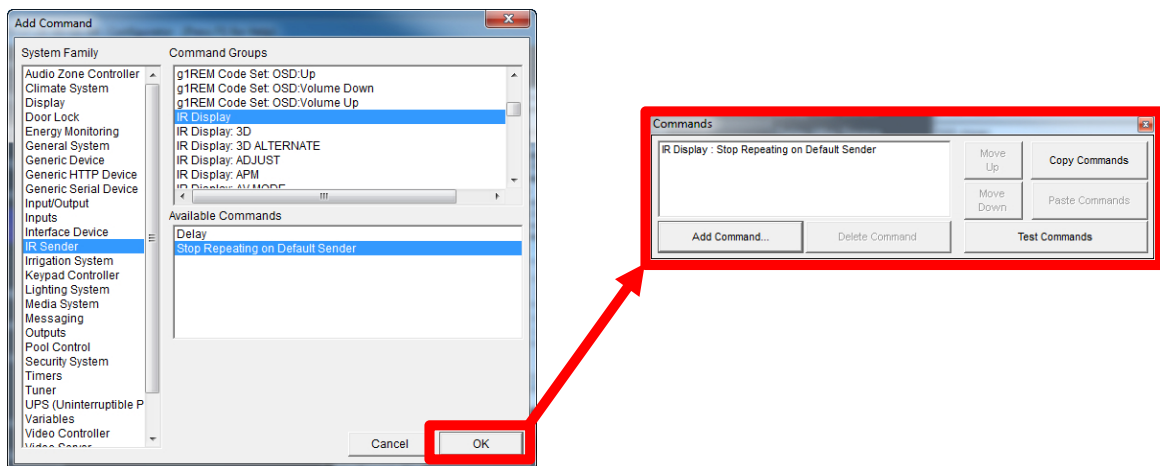

Note: The Stop Repeating on Default Sender command tells the g system to stop sending the repeating command.

- j. Repeat steps 5a thru 5i to add **Begin Volume Down** and **End Volume Down** commands.
- 6. Click the **Power On** controller command. *The Commands Window is displayed. Note that there is no command present for Power On.*
 - a. Select the **Add Command** button in the Commands window. *The Add Command window appears.*

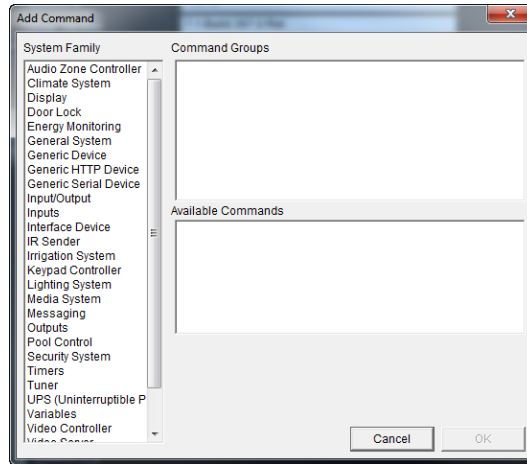

- b. In the System Family column, select the **IR Sender** family. *Command Groups populates with the IR devices setup earlier.*
- c. In Command Groups locate and select **IR Display: POWER ON**. *The Available Commands box displays the command options for the selected Command Group.*
- d. In Available Commands select **Send IR via Default Device** and select **OK** when finished. *The Add Command window closes and the Commands window shows the newly added IR command.*

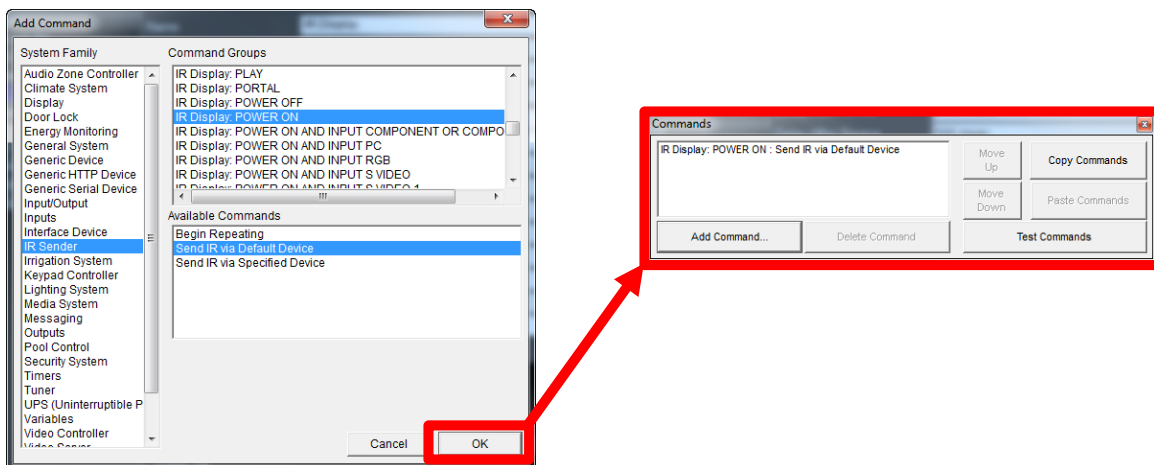

Note: Send IR via Default Device command sends the selected IR command out the IR output port assigned in Exercise 3.

- e. Repeat steps 6a thru 6d to add the **Power Off** and **Mute Toggle** commands.
7. Click the **(Source 01)** controller command. *The Commands Window is displayed. Note that there is no command present for (Source 01).*
 - a. Select the **Add Command** button in the Commands window.
 - b. Select the **IR Sender** System Family.
 - c. Select **IR Display: INPUT HDMI 1** in Controller Groups.
 - d. In Available Commands select **Send IR via Default Device** and select **OK** when finished.

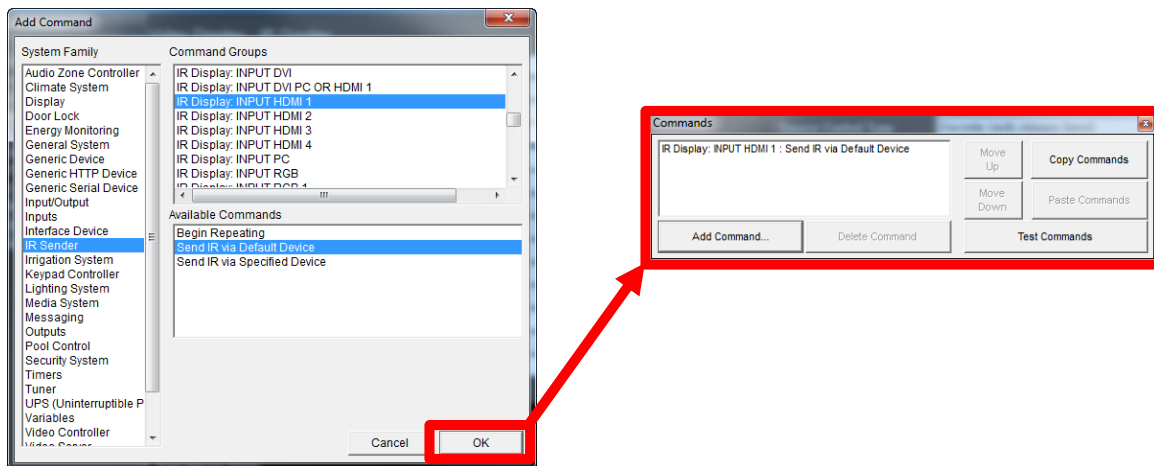

Note: Send IR via Default Device command sends the selected IR command out the IR output port assigned in Exercise 3.

- e. Repeat steps 7a thru 7d to add **IR Display: INPUT HDMI 2** command to the **(Source 02)** controller command.
- f. When finished select  to close the Commands window.

Exercise 8: Create and Customize an Interface for an IR Source

Overview In a previous exercise, you created an IR Device with all proper settings and codes for your source device, in our example the Satellite box. In Exercise 8, you will create an interface to control the device using these IR codes. First, you will create the interface on the Media tab and associate it with the IR device. This will enable source selection on a zone controller and display the interface in the Viewer to allow control of the IR source device.

The g! software provides multiple templates to use as starting points for controlling your IR devices. While these templates cover the most common controls, you may want to customize the interface in order to provide the right amount functionality for the project. This is accomplished by adding, or deleting, controls to the default interface and then arranging the layout appropriately.

Note: To preview what controls exist on the built-in templates, navigate to Interface Templates on the Media tab in the Configurator.

In this exercise, you will add an interface for a Satellite box using a predefined template, and then customize it by adding a new button.

How-to

1. Navigate to the **Media** tab in the Configurator.
2. Right-click the Sources node, and select **Add New Custom Source** from the menu. *The Add New Custom Source window appears.*
 - a. Name the new interface “**Satellite Box**”.
 - b. From the **Copy Layout From Template** drop-down list, select **DirectTV Basic Favorites**
 - c. In the **Connect to Existing Device** list select **Satellite**.
 - d. Click **OK**.

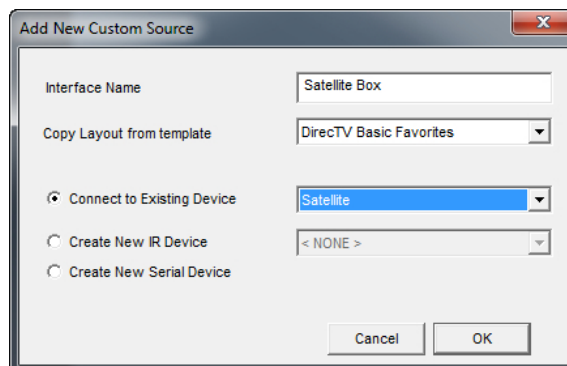

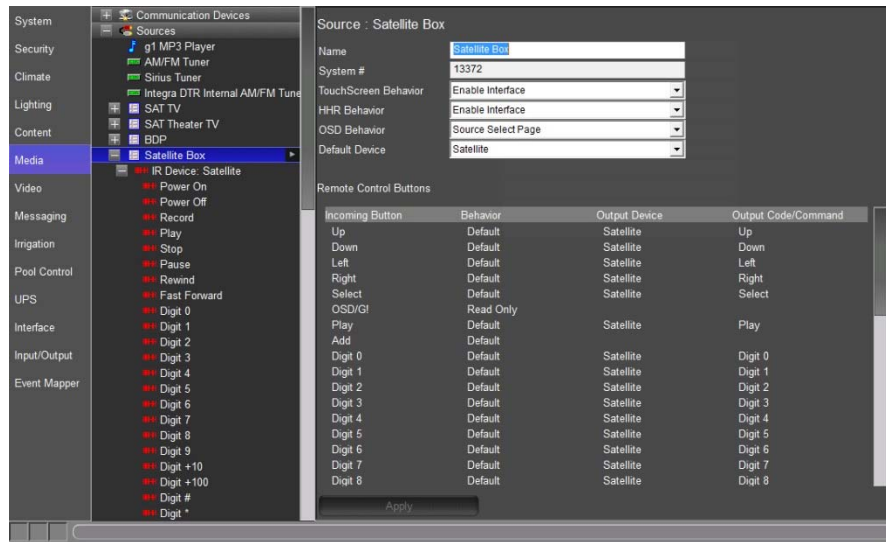

Note: Selecting the Satellite IR device that was created previously sets it as the Default Device for this interface. Any button that is pressed that has a Universal Function associated with it, will issue the associated IR code from the Satellite IR device.

3. Select the Satellite interface and verify that the default device **Satellite** is selected. *The default device drop down list allows selection of any configured IR device, serial device, or built-in driver. The selected device’s commands will be mapped to the buttons on the interface via the Universal Function assignments.*

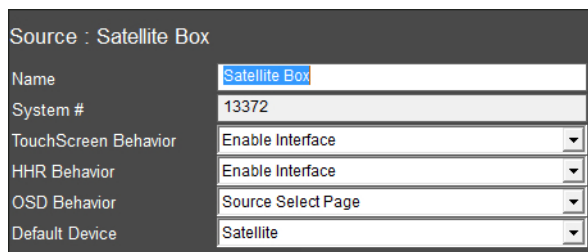

4. Expand the entry for your new Satellite Box interface by clicking the “+” sign to its left.
5. Click the Large Format to select it, and then click Large Landscape(Standard) in the properties pane on the right. *The **Interface Layout** for the Satellite Box displays in the Properties Pane to the right:*

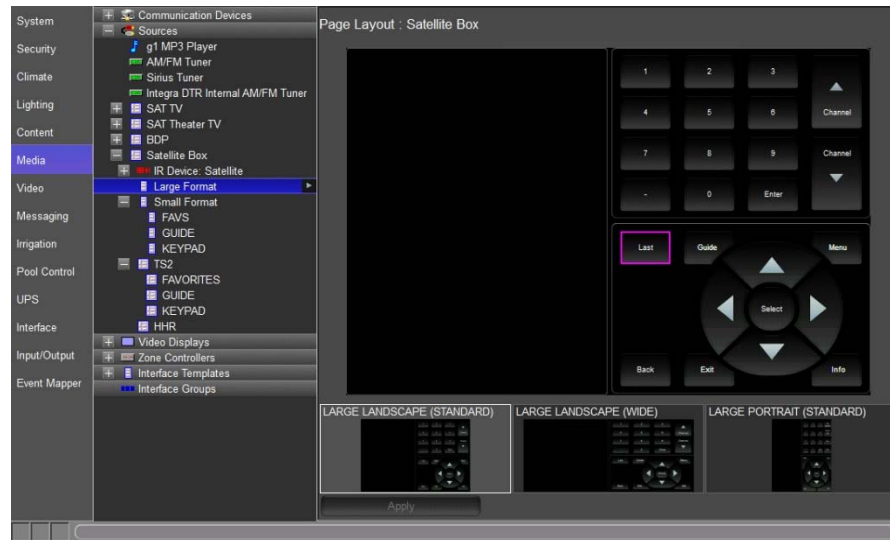

Note: In g!Tools the Viewer button default is Wide. The Large Landscape (Wide) interface is what will be used to populate the Viewer. If Large Landscape (Standard) is desired set the Viewer to Traditional in g!Tools. Some older PC's may only run the Viewer in Large Landscape (Standard) mode.

6. Add a new button for the **List** command.
 - a. In the Interface Layout, right-click the space between the Last and Back buttons and select **Add New Control**. *The Add New Control dialog box opens.*
 - b. Select **Audio Button** from the list of available controls. *The Audio Button is a special type of button which allows you add commands to the button directly in the interface. This button is only available on the Media Tab.*

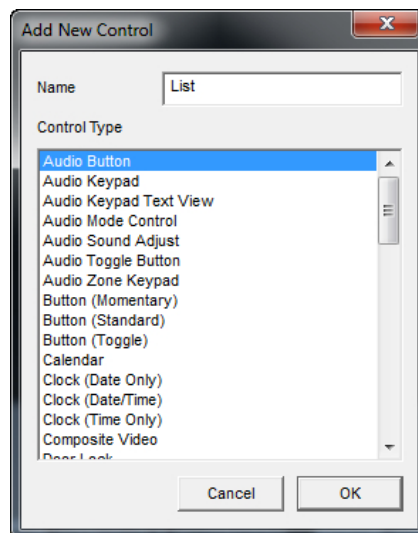

- c. Change the name of the button to **"List"**

- d. Click **OK**. A new button labeled “List” is added to the Interface Layout.
7. Click the new button in the Interface Layout to select it. *The Audio Button Properties window opens.*

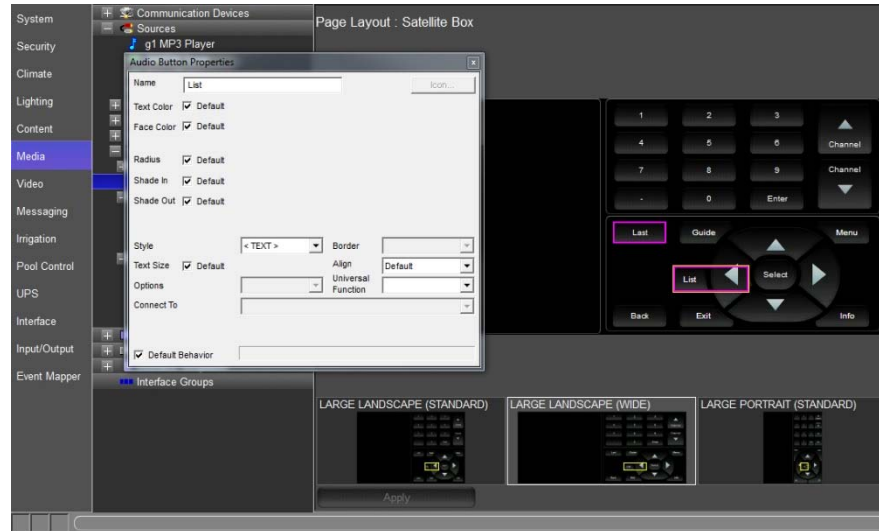

8. In the Audio Button Properties window, select **List** from the **Universal Funct**: drop-down list. Click **Apply**.

Note: Setting the Universal Function is an important step, since it allows this button to automatically map commands to the List IR code for the Satellite box. Alternatively, de-selecting the “Default Behavior” check box in the button properties window lets you manually assign button commands to that button.

9. Drag the button to place it roughly into position below the **Last** button in the interface.
10. Align and size the button more precisely as follows:
 - a. Click the **List** button to highlight it.
 - b. Hold the Control (Ctrl) key on your keyboard and click **Last**.
Each of the buttons will be highlighted in yellow, and the group will be highlighted in green.
 - c. Right-click one of the buttons and select **Make Same Height**.
 - d. Right-click again and select **Make Same Width**. *Both buttons will now be the same size.*
 - e. Right-click one of the selected buttons and select **Align Right Edges**. *The right edge of the Menu button will line up with the right side of the Back button.*
 - f. Hold the Control (Ctrl) key on your keyboard and click **Back**.

- g. Right-click one of the buttons and select **Space Evenly (Y)**.
- h. Click **Apply** to save your changes.

Your interface should now look similar to the one shown below:

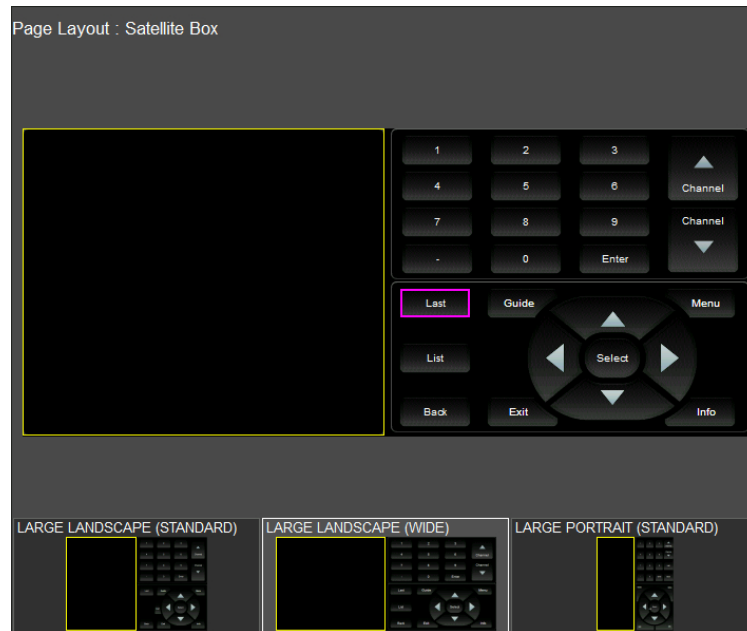

Exercise 9: TV Channel Favorites

Overview The g! software provides a pre-made interface for one-touch selection of favorite TV channels. The interface will display icons for favorite channels separated into groups like News or Sports. By clicking the TV channel icon in the Viewer, the g! software automatically translates this button press to the correct channel number and sends the digits to the cable/satellite box.

If the home has more than one television source, cable and satellite for example, the software can support multiple “tuning types” so that each network can have more than one channel number associated with it. For example, The Disney Channel might be channel 304 on the cable box and 215 on the satellite. The Viewer displays The Disney Channel icon for the homeowner to select, and the software tunes to the appropriate channel for whichever source is currently in use.

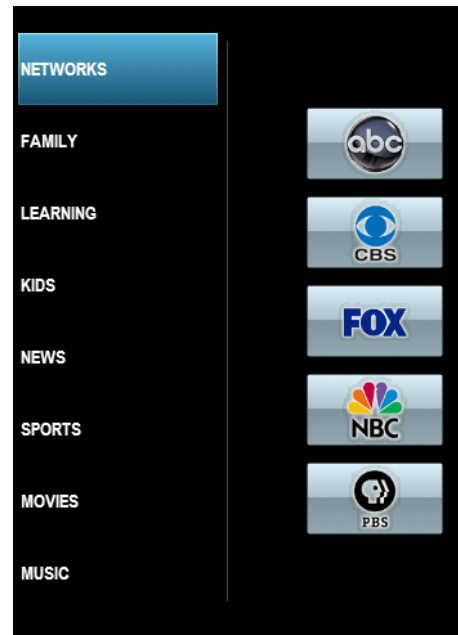

This exercise details how to add the TV Channel Favorites Control to a source interface, and to configure TV Channel Favorites for proper function.

Before beginning this exercise, be sure you have completed Exercises 2 through 8 in this lesson.

The basic steps of adding TV Channel favorites are:

1. Configure the IR Device by selecting the appropriate tuning type, minimum digits, and pre- and post-tune commands as necessary.
2. Configure the TV Channel favorites on the Content tab by entering the channel numbers for the appropriate tuning type.
3. Add a TV Channel Favorites control to a custom interface and connect it to the appropriate IR Device.

How-to

1. Navigate to the **Media** tab in the Configurator.
2. Select **IR Device: Satellite**. *The IR Device properties display on the right:*

Note: The Tuning Type is used by the TV Channel Favorites control to send the correct channel number to the Satellite Box IR device. Later, you will learn how to add multiple channel numbers for each TV Channel saved in favorites. There are five Tuning Types available, so that up to five different channel numbers can be selected for each network (channel). The Tuning Type used here controls which number is sent when the interface for this device is used.

There are other settings below Tuning Type that affect TV Channel Favorites controls. For this exercise, we will assume the defaults are correct.

3. Select **Satellite (Type 1)** from the **Tuning Type** drop-down list and click **Apply**.

IR Device : Satellite Box	
Name	Satellite
System #	12968
Default Sender	IR Output 06
RC5 Codeset	No
Decode IR from this device	No
Tuning Type	Satellite (Type 1)
Minimum Digits (0 Padding)	0
Pre-Tune Command	< NONE >
Post-Tune Command	< NONE >
Delay Between Commands	250 msec

4. Set the **Minimum Digits (0 Padding)** drop down if needed.
5. Set the Pre-Tune Command to **Enter**.
6. Set the Post-Tune Command to **Select**.
7. Set the **Delay Between Commands** if needed. The default of 250 msec is OK for most devices.

IR Device : Satellite Box	
Name	Satellite
System #	12968
Default Sender	IR Output 06
RC5 Codeset	No
Decode IR from this device	No
Tuning Type	Satellite (Type 1)
Minimum Digits (0 Padding)	0
Pre-Tune Command	Enter
Post-Tune Command	< NONE >
Delay Between Commands	250 msec

8. Click **Apply** when finished.

9. Click on the **Content** tab in the Configurator.
 - a. In the System Node Tree, navigate to **TV Channels**, and then select the first entry in the list. *The properties for TV Channel are shown on the right:*

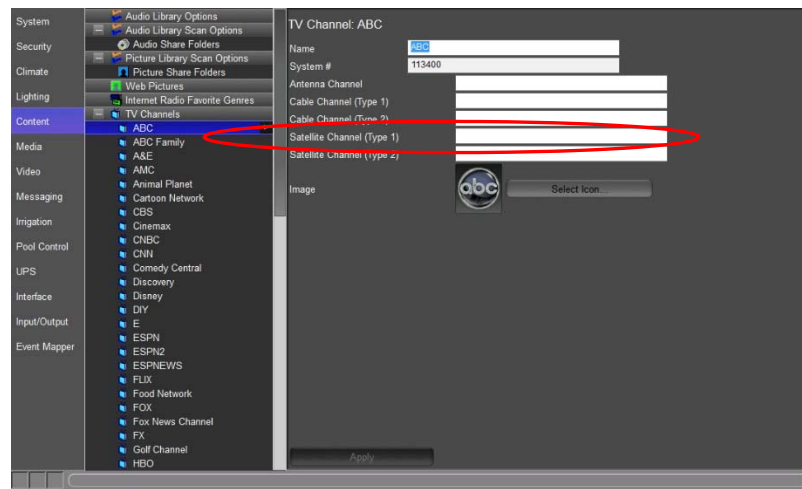

- b. In the **Satellite Channel (Type 1)** field, type the channel number for the selected station from the Satellite provider. For this exercise, type in channel number 675, and click **Apply**. *In a real install, these are the digits that will be sent to the satellite box when the favorite channel is selected from the interface connected to the Satellite Box IR Device, since Satellite (Type 1) is its tuning type.*

Note: There are two Cable channel types, two Satellite channel types, and an Antenna channel type, allowing you to use the same TV Favorites interface for five different kinds of devices.

The names are not important as long as the type selected for the IR device matches the channel number entered in the Content tab. Each IR device's **Tuning Type** field controls which channel number from these settings are sent when activated from the interface for that device.

In an actual install, you would now go through and enter the correct channel numbers for each TV Channel Favorite. This is also the time when you would add additional channels, upload new icons from your files or the icons library in g!Tools, and edit/customize the channel groups.

- c. Repeat the above steps for entering the correct TV channel number for each desired favorite TV icon.
 - d. Navigate to the TV Channel Groups node and select the **Networks** TV Channel Group.
 - e. Verify that the all the desired TV channels are in the Selected Channels column for display in the g! Viewer.

Note: The g! Viewer only displays TV Channel Icons that are assigned to a TV Channel Group.

- f. Repeat for each additional TV Channel Group, adding TV channel icons to the group from the Available Channels column.

Note: ELAN strongly recommends that you create a backup of your settings after fully editing TV Channels and Groups.

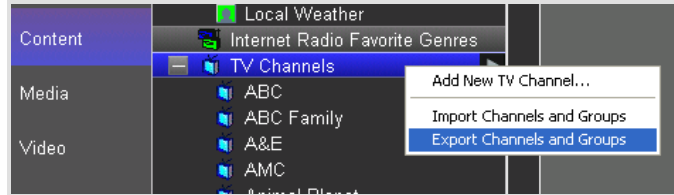

This will allow you to import your TV Channels to the Content tab and not spend time entering channel numbers at each job. When you create your master file, it's a good idea to enter channel numbers under different tuning types for each type of service you will use, such as DirecTV, Comcast, etc., so that you do not need to update this file more than once.

To export/import your files, right-click on either the TV Channels or TV Channel Groups heading and select Export/Import TV Channels and Groups.

Note: You will not be able to see this interface in the Viewer until it is added to a Zone Controller. See the *Distributed AV* and *Configuring Home Theater* lessons for details.

- g. When finished navigate to the **Media** tab in the configurator.

Exercise 10: Set Up the IR Display as a Zone Controller

Overview In Exercises 7 thru 9 we added an IR Display and an IR Source to the g! software. In this exercise we will setup the IR Display for use as a zone controller. In this application the IR Display will provide source switching and volume control in the zone.

Before beginning this exercise, be sure you have completed Exercises 2 thru 9 in this lesson.

For Exercise 10, you will configure the IR Display for 2 sources and setup the IR Display Zone.

- Source 1 will be the **Satellite Box**
- Source 2 will be Output 4 on the Atlona AT-HD-V44M

How To

Set up the Video Display

1. In the **Media** tab System Tree, click the plus (+) sign next to **IR Display** to expand the Zone and Source List for the IR Display when used as zone controller.
2. Select **(Source 1)**. *The Properties Pane to the right displays the properties for the selected IR Display's source.*

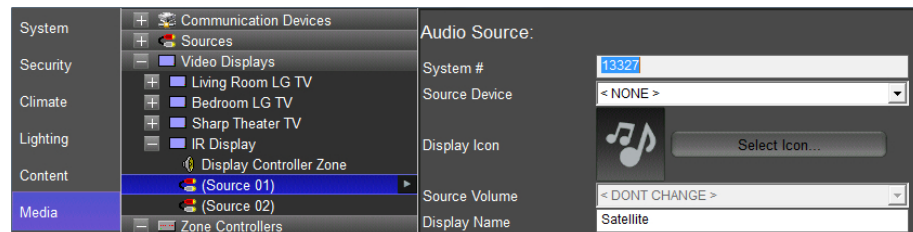

- a. Select the **Interface: Satellite Box** from the Source Device drop-down menu and click **Apply**. *The (Source 1) entry in the System Tree changes to show its association with the Satellite Box.*

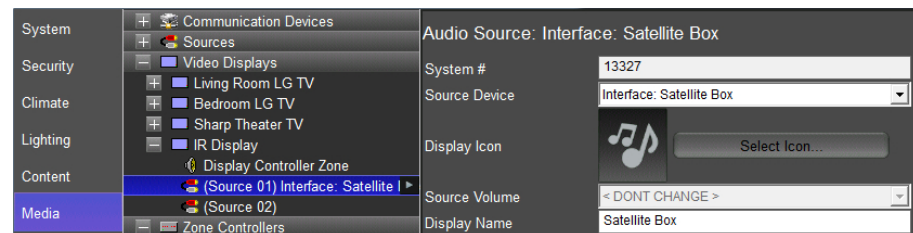

- b. In the properties window, click the **Select Icon** button and choose the icon that should be used for the source and click **OK**.

- c. Change the Display Name to **Satellite Box** and select **Apply**. When finished, your screen should look similar to the screen below.

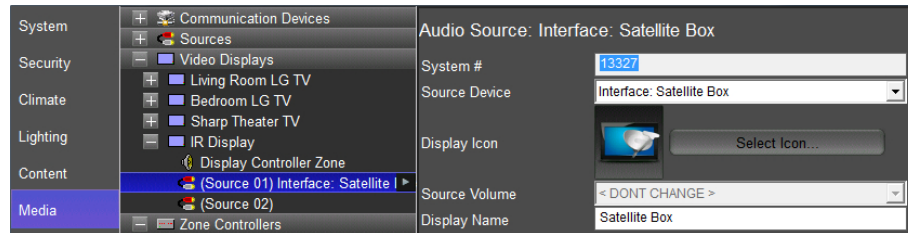

3. Navigate to the Zone Controllers node and click the (+) to expand the Atlona AT-HD-V44M Zones node.
 - a. Select the **AT-HD-V44M Output 4** node. *The Properties Pane to the right displays the properties for the selected Atlona Output.*
 - b. Enter the name **IR Display Zone** and select **Apply**.
4. Return to the IR Display node and select **(Source 2)**. *The Properties Pane to the right displays the properties for the selected IR Display's source.*
 - a. From the Source Device drop-down select **Output From: Atlona AT-HD-V44M: Zone IR Display Zone** and click **Apply**. *The (Source 2) entry in the System Tree changes to show its association with the Atlona Output.*



Note: Do not set the Display Icon and the Display Name. Display Icons and Display Names created in the Zone Controller of origin will be carried over when the Output From is selected as a Source Device.

5. Select **Display Controller Zone**.
 - a. In the Name field enter **Study** and select **Apply**. *The Display Controller Zone entry in the System Tree changes to Study.*

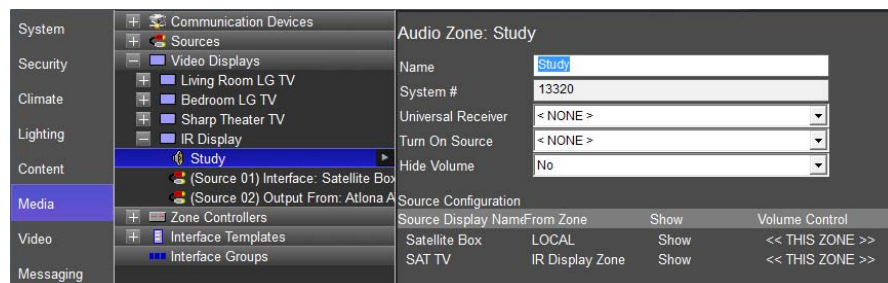

6. Navigate to the **Interface Tab** in the Configurator.
 - a. Select **(+)** to expand the interface(s) being used.
 - b. Select **Tab Config: Media System**.
 - c. Verify that the **Study** is in the Visible Tabs column. *If the Study is not in the Visible Tabs column proceed to step d. If the Study is in the Visible Tabs proceed to step 7.*
 - d. Select **Study** from the Available Tabs column.

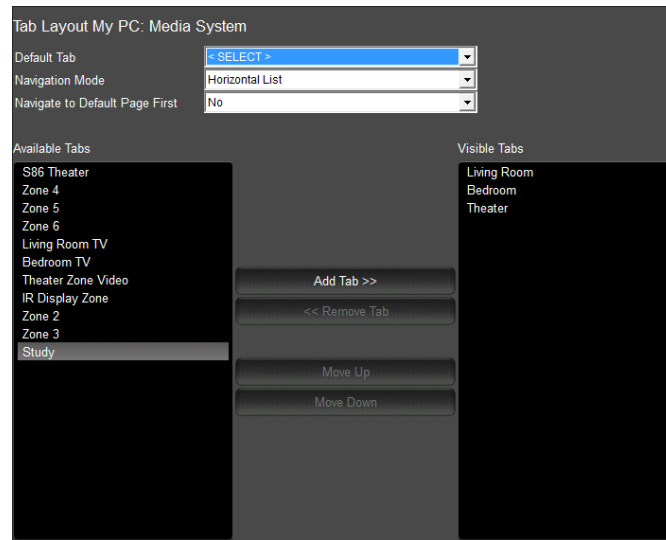

- e. Select **Add Tab >>** button and select **Apply**. This will make the Study visible when using the selected Interface Device.
- f. In the Visible Tabs column move the **Study** to the top and select **Apply** when finished.

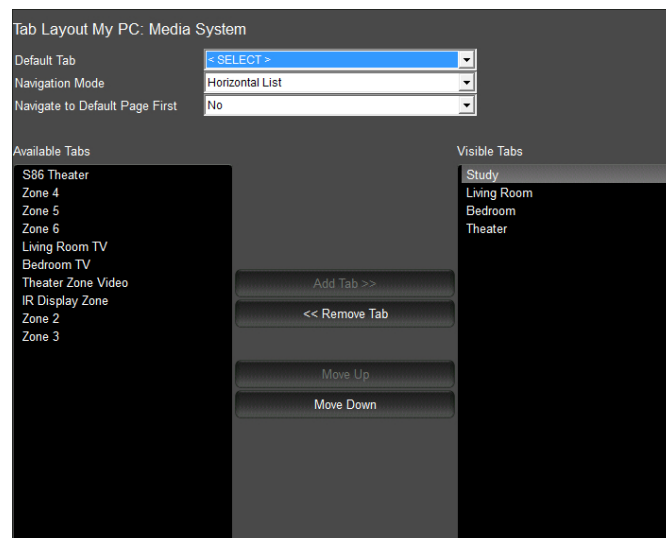

7. Minimize the g!Configurator and **maximize, or open, the g!Viewer**.

8. Select **Media** and verify that the **Study** is to the left of the other zones.

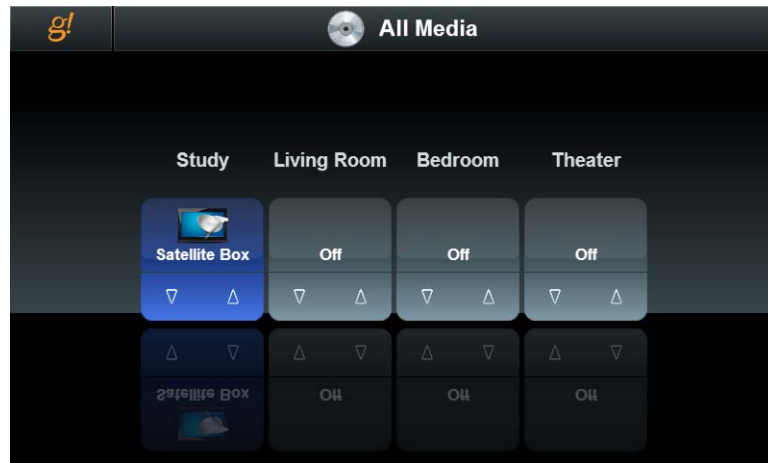

9. Verify both sources appear appropriately on the source page.



10. Verify all functionality of the zone and sources from the viewer.



Note: Since some, or all, of the gear is not present we will assume that functionality is correct. When working with a live gear this procedure should be followed.

Lesson 10

Generic Serial Control (One-way)



Overview

This lesson shows you how to use the Generic Serial Device driver to add support for any RS-232 device that you can control with basic RS-232 commands.

You will:

- Learn how to add serial commands for one-way control of serial devices.
- Understand Universal Functions and how they apply to Generic Serial Devices and Interfaces.
- Learn how to use Generic Serial Device commands to control devices from the g! software.
- Learn how to export and import Generic Serial Devices.

Requirements

- A g! system controller and g!Tools
- RS232 controlled device

Overview

Overview The Generic Serial Device driver is used for sending one-way commands to a serial controllable device that either does not benefit from a full 2-way driver in the g! software, or for which a 2-way driver is not available. The Generic Serial Device driver is not intended to support full two-way communication, and is primarily used for devices that do not provide feedback.

Examples of devices that are well suited as Generic Serial Devices are audio and video sources (such as DVD players) and video displays (televisions or projectors). The Generic Serial Device driver is not intended for devices like tuners and receivers, where the two-way feedback (the current station on a tuner or the active source on the receiver) is important.

The following diagram shows the basic equipment in a system schematically. The diagram includes the components that are important to the g! system controller.

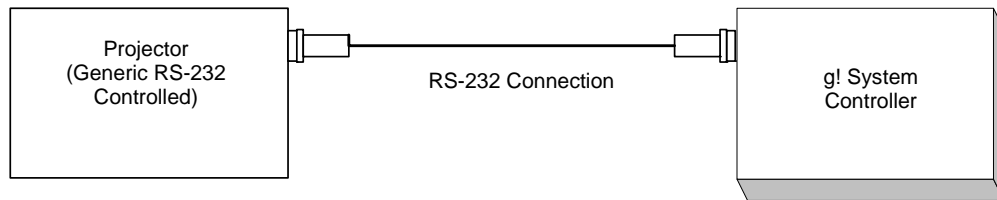

Terms

The following terms are used in the Configurator:

- **Communication Device:** The serial port or other communication method used to communicate with the device.
- **Generic Serial Device:** The device group containing serial commands and other information related to the device on the Input/Output Tab.
- **Universal Function:** A tool used to map controls in the interface to their associated commands in the Generic Serial Device.
- **Hex or Hexadecimal:** Code language commonly used in serial commands. Hex code strings use numbers and certain letters to represent the numbers 0-15. 0-9 equates 0-9, with A-F equating 10-15. Hex codes are often denoted by the presence of a small "h" at the end of a letter sequence. Sample: 02h
- **ASCII:** Code language commonly used in serial commands. ASCII strings are typically human readable text, such as ABCDEFG0123 etc.
- **Binary:** Code type consisting of 1's and 0's, representing ON and OFF respectively. Binary concepts are used frequently in serial codes, with the same command with a 1 or 0 on the end indicating whether to activate or deactivate that function.
- **Generic Display:** A Generic display driver that allows custom mapping of commands such as source and power. This display may be connected to a zone in zone settings for automatic switching based on source selection.
- **Interface:** The customizable button layout that makes up the user interface in the Viewer.

How-to

To integrate a generic serial controlled device:

- Add the Communication Device.
- Add the Generic Serial Device, including adding commands.
- For displays: add a Generic Video Display, map the commands appropriately and configure this display in a zone.
- For sources: add the Interface, map commands and configure the Zone Controller for the source interface.
- For other items: Configure appropriate Event Mapping.

Exercise 1: Add Generic Serial Devices from a Protocol Document

Overview In Exercise 1, you will add a Generic Serial Driver for a projector. A projector is a good candidate for one-way serial control as they typically do not provide feedback, and there are a limited number of commands required to program.

- How-to*
1. In the Configurator, click on the **Input/Output** tab. Right-click **Communication Devices** and click **Add New Communication Device**. *The Add New Communication Device window opens.*
 - a. Enter "**Projector**" as the **Device Name**.
 - b. Set **Communication Type** to **Generic Serial**.
 - c. Set the **Hardware Type** to **Serial Port**.
 - d. Assign the **COM Port** from the drop-down menu.
 - e. Click **OK**.

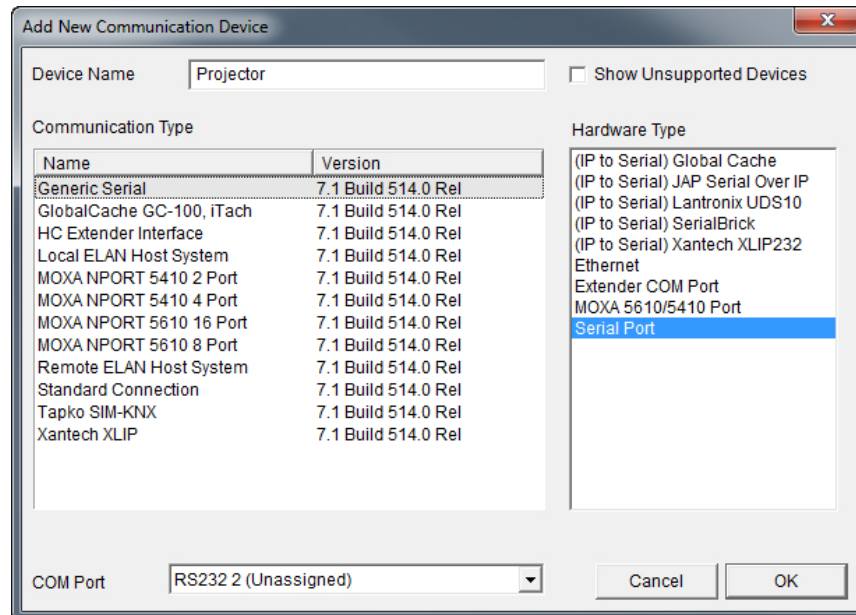

Note: The communication type selection shows as Standard Connection when added, but will automatically change to Generic Serial and allow editing when linked to a Generic Serial device.

2. Right-click on **Generic Serial Devices** and **Add New Generic Serial Device**. *The Add New Generic Serial Device window opens.*

3. Select Generic Serial Device, type "**Projector**" in the **Name** field, and then click **OK**.

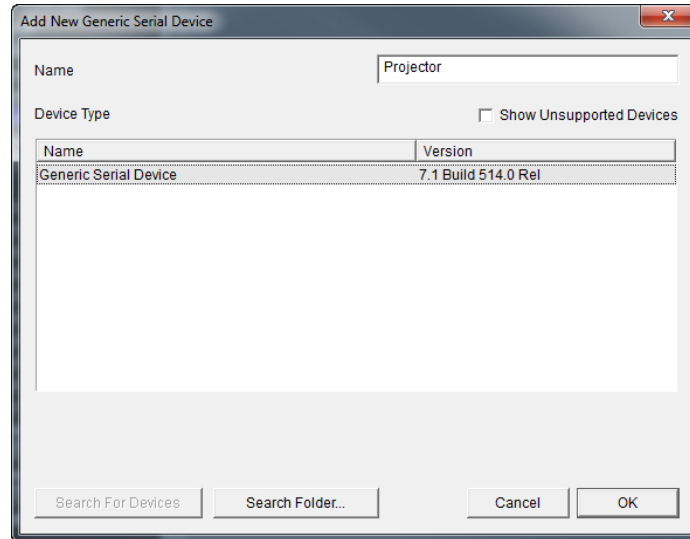

Notice the Generic Serial Device has automatically linked to the Communication Device added in Step 1.

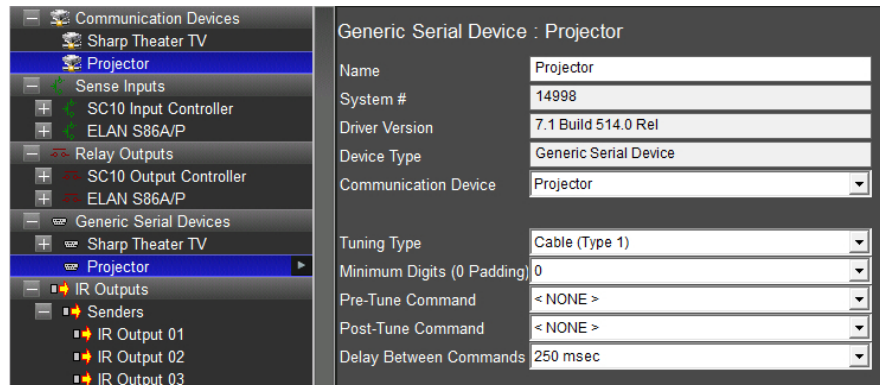

4. Click **Projector** under **Communication Devices** in the System Tree to verify the baud rate and other serial settings are configured correctly for this device.

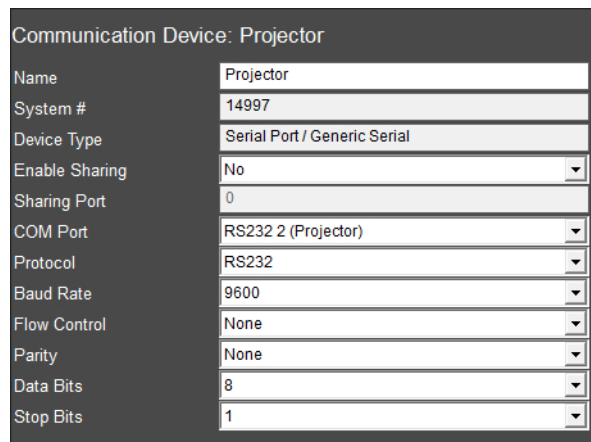

Note: For this exercise we will assume the default settings are correct, but in a real install all the serial settings must **exactly** match those indicated in the serial protocol for the device for communication to be effective.

5. Navigate to the Generic Serial Devices Projector in the System Tree, and right-click **Projector**. Select **Add New Serial Code**. *The Add New Serial Code window opens.*
6. Name the code **Power On** and click **OK**. *The code is added below the Generic Serial Device named Projector and should be automatically highlighted, and the properties display on the right.*

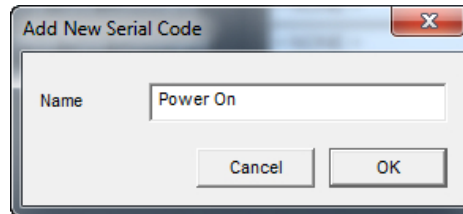

7. In the Power On properties, select **Power On** from the **Universal Function** drop-down list. *Before entering the code, it is important to select the Universal Function so that the g! software can properly associate the command with the control.*

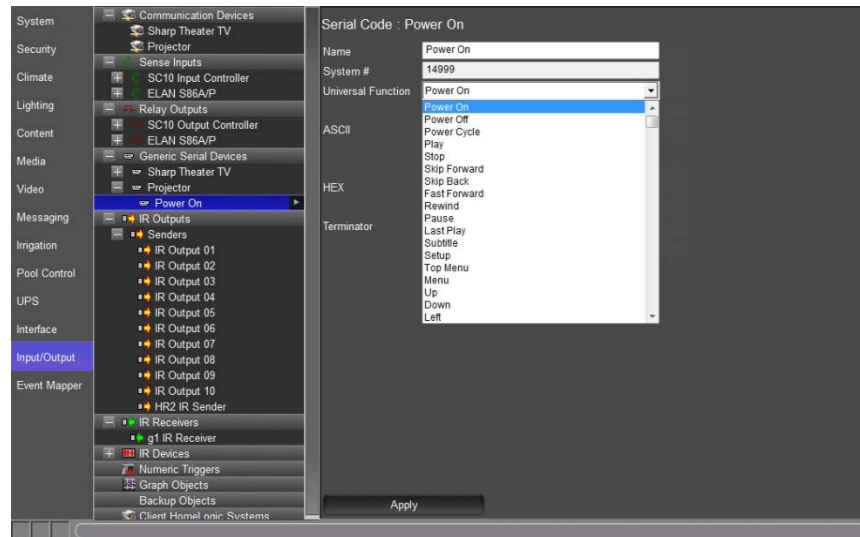

8. Now that the Universal Function is entered, enter the serial code for the projector. For this exercise, assume the power command is the ASCII string "Power1<cr>".

Note: Codes like <cr> are common in serial commands, and refer to "carriage return" or "enter".

9. You will add the code in two steps:

- a. Enter the ASCII string in the box labeled ASCII. The ASCII string is the text portion of the code prior to <cr>; “Power1”. Notice that as you do so the hex equivalent of your ASCII string is displayed in the HEX box.

Note: Some serial commands are case sensitive. Refer to the protocol document for details.

Serial Code : Power On

Name	Power On
System #	27522
Universal Function	Power On
ASCII	Power1
HEX	50 6F 77 65 72 31
Terminator	None

- b. Enter the carriage return, which terminates the command and lets the projector know that this is the end of the command sequence. Since “carriage return” is not a character that can be displayed in ASCII, you will not enter anything into the ASCII field (pressing enter at the end of Power1 will **not** add the carriage return for you). Instead, select **Carriage Return** from the **Terminator** drop-down list.

Serial Code : Power On

Name	Power On
System #	27522
Universal Function	Power On
ASCII	Power1
HEX	50 6F 77 65 72 31
Terminator	Carriage Return

- c. Click **Apply** to save.

Note: The g! software allows you to automatically append common terminators like carriage return and linefeed to the end of serial commands through the drop-down. If your particular serial protocol requires a different terminator, you can enter the terminator's hex code into the hex field.

Typically, a small box will appear at the end of the ASCII string to indicate the presence of a non-display character (Vista users may not see this box). For example, a carriage return's ASCII code is 13. Since entering 13 into the ASCII string will send 1...3, you enter 0D into the hex field to append the correct data.

10. Add the rest of the codes. In total, you will add 3 more codes to this generic serial driver: **Power Off**, **Component Input**, and **HDMI Input**.
 - a. To add the **Power Off** command, right-click on the Power On code and select **Add New Serial Code**. *The Add New Serial Code window opens.*
 - b. Name the code "Power Off", and click **OK**.

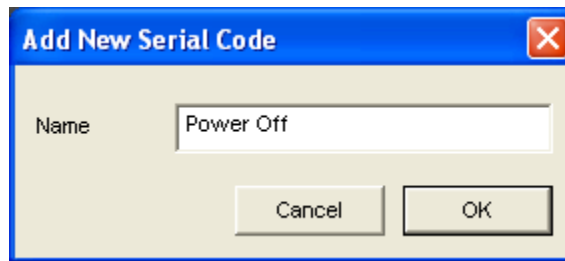

- c. Select the Universal Function pointer for Power Off from the Universal Function drop-down list.

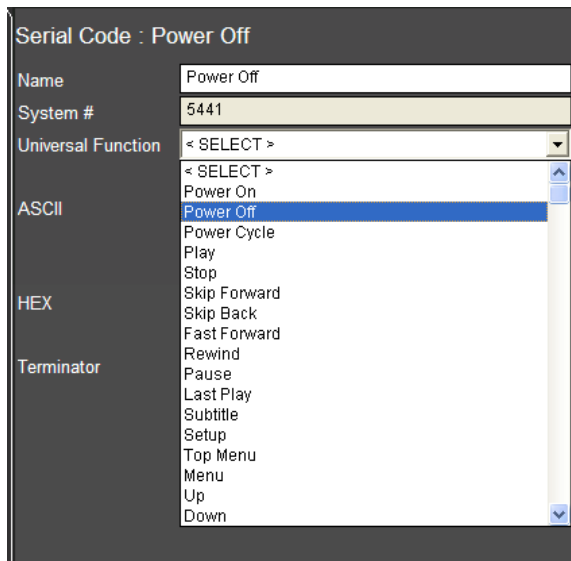

- d. The code string to turn the projector off is **Power0<cr>**. Refer to steps 10a and 10b to enter the command:
 - Enter **Power0** in the **ASCII** box

- Select the **Carriage Return** separately from the **Terminator** drop-down.
- Click **Apply** when finished.

Serial Code : Power Off	
Name	Power Off
System #	5441
Universal Function	Power Off
ASCII	Power0
HEX	50 6F 77 65 72 30
Terminator	Carriage Return

11. Refer to steps 10a and 10b to add the two input commands, being sure to set the Universal Function (inputs are listed as Source Video # etc). The commands for the remaining inputs are:

Input1<cr> for the **Component** input.

Input2<cr> for the **HDMI** input.

12. The completed commands should look like the following:

Component

Serial Code : Component	
Name	Component
System #	5445
Universal Function	Source Video 1
ASCII	Input1
HEX	49 6E 70 75 74 31
Terminator	Carriage Return

HDMI

Serial Code : HDMI	
Name	HDMI
System #	5449
Universal Function	Source Video 2
ASCII	Input2
HEX	49 6E 70 75 74 32
Terminator	Carriage Return

13. Once all the codes are added, it is a good idea to test them. To test codes at any time, navigate to the **Input/Output** tab, right-click on the code and select **Test Code Now**.

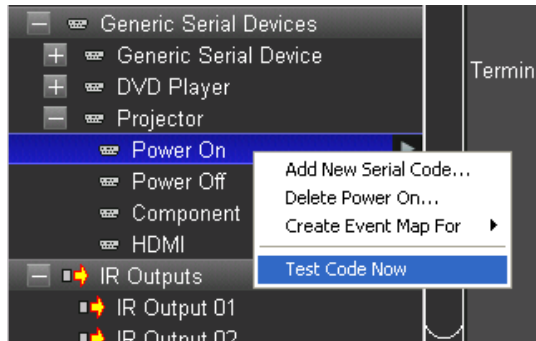

Note: Since actual equipment is not installed for this lesson, we cannot know the effectiveness of the command and will assume it is valid. On a real installation, testing codes can be very helpful when developing Generic Serial Drivers, and is an important part of the driver creation process.

14. Once you have fully tested the serial driver, cleaned up any codes, and added all Universal Functions, it is a good idea to **Export** the verified driver. This allows you to start to build a database of drivers you can control regularly.
- a. To export files, right-click on the name of the Generic Serial Driver and select **Export to File**.

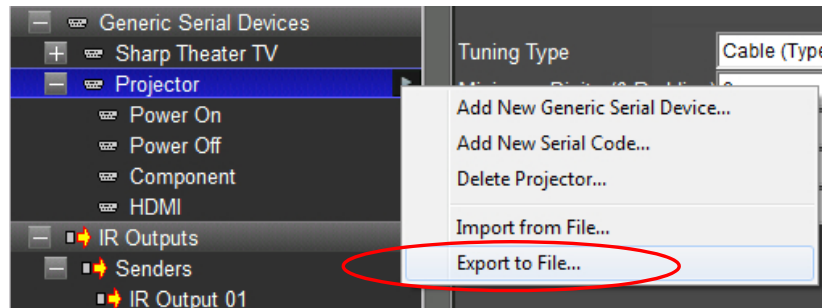

b. The Export Serial file dialog box opens:

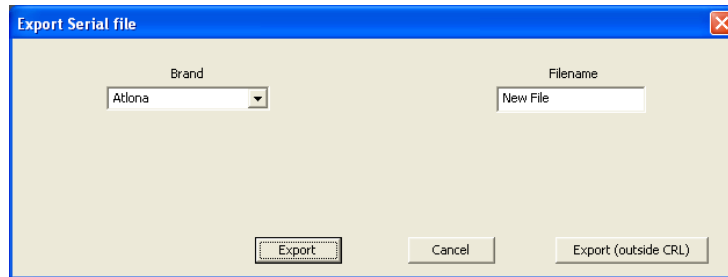

- Select the appropriate category from the drop down list, and then enter a descriptive name in the New File text field.
- Click **Export** to save the file into g!Tools.
–or–
Click **Export (outside CRL)** to open the Windows Save As dialog box to save the file elsewhere on your computer or network.



Note: This file can be imported to any g! system running the same version or a later software version. This is useful if you have multiple units of the same type on one job, or will use this device again on another job. Even if you don't think you will use the device again, it is always a good idea to make a backup file.

Exercise 2: Create a Generic Display

Overview Once you have created a Generic Serial Device, you now have a database of codes you can use in the system. For a projector or other video display, the best way to use this database is to attach the codes to a Custom Video Display. Then you can assign that display to an A/V zone for automatic power and input switching based on source selection. (See the lessons on *Configuring Distributed A/V (Parts 1 and 2)* or *Configuring Home Theater Systems* for more information.)

Adding a display in the Media tab makes the display available for assignment to an audio zone and/or allows the video display to be used as a Zone Controller.

Quick Reference: Custom Video Display	
Name	Editable field used to name the video display.
System #	Unique, read-only number assigned by the g! software for internal use.
Driver Version	Core module rev the driver was last verified in.
On Off Control Type	How the display is turned on. Options are: Cycle (Tracking Enabled) – Uses the same command to turn the video display on and off. Tracking enabled allows g to track the On/Off status of the display. Cycle (Tracking Disabled) - Uses the same command to turn the video display on and off. Tracking disabled means g will not track the On/Off status of the video display. Discrete – The g system will send the power on or power off command when requested. Discrete Verify (Always Send) – The g system will send the power on or power off command every time a source associated to the video display is selected.
Source Control Type	Cycle - Uses a single command to toggle between the available source inputs. Discrete – The g system will send the individual command for the specified source input. Discrete Verify (Always Send) – The g system will send the individual command for the specified source input every time a source is selected that is associated to an input on the video display.
Delay After On/Off	The amount of time that has to expire before the video display can accept another command. Time setting is in milliseconds from 100 to 14900.
Delay After Source	The amount of time that has to expire before the video display can accept another command. Time setting is in milliseconds from 100 to 14900.
Volume Control	Allows the volume to be adjusted for the video display from a g User Interface.
Mute Control Type	Sets how the video display will use the mute command. None – There is no mute command for the video display. Toggle – There is a single command for mute that toggles between mute on and mute off. Discrete – There is a separate mute on and separate mute off command for the video display that is managed by g.

Provide Local Sources	Set to Yes when the area will be split between 2 zone controllers (i.e. an MRA & a Video Display) with independent volume control for both zone controllers.
Provide Audio Return	Set to Yes when connecting the audio output from a video display to an audio input on a zone controller (i.e. AVR, MRA, GSZC) in order to enable the Audio Return Input option in the zone node of a zone controller.
ELAN UltraMatrix ARP	Set to Yes if ARP (Audio Return Program) will be a source option for the ELAN gMV UltraMatrix. This option is greyed out if no gMV is being used in the system.
Show as Zone	Set to Yes to show the video display as an independent zone.
Controller Commands	Shows the available command names that are associated with the video display. Selecting a command name brings up the Command window for adding Serial or IR commands.

*How-to***Add a video display for the Theater Zone**

1. In the Configurator, on the **Media** tab, right-click the Video Displays node and select **Add New Video Display**. *The Add New Video Display window appears.*
 - a. Enter **Projector** in the Name field.
 - b. Select the **Custom Video Display** Device Type.

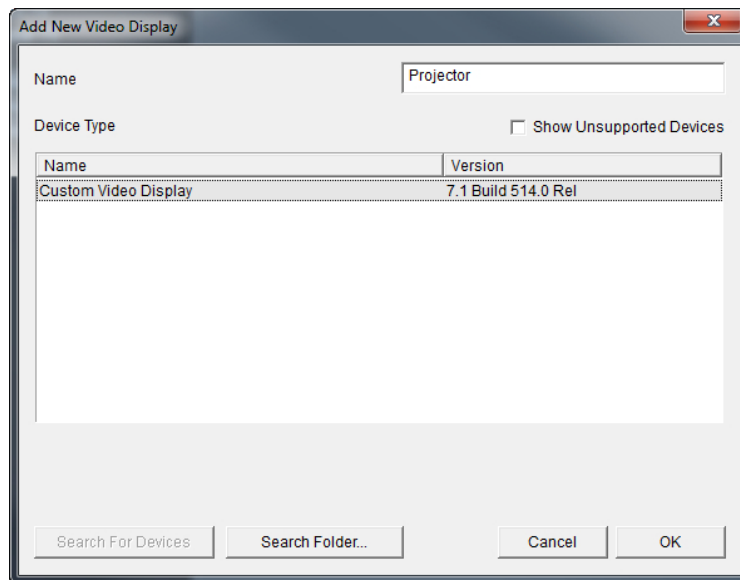

- c. Click **OK**. *The Projector appears in the Video Displays node.*

- Click the **On Off Control Type** drop down and select **Discrete**. *The Controller Commands section in the Properties Pane now shows Power On and Power Off command names.*

Video Display : Projector

Name	Projector
System #	15015
Driver Version	7.1 Build 514.0 Rel
Device Type	Custom Video Display
On Off Control Type	Discrete
Source Control Type	Cycling
Delay After On/Off	100 msec
Delay After Source	100 msec
Volume Control	Yes
Mute Control Type	Toggle
Provide Local Sources	No
Provide Audio Return	No
Elan UltraMatrix ARP	No
Show as Zone	No

Controller Commands

- Begin Volume Up
- End Volume Up
- Begin Volume Down
- End Volume Down
- Power On
- Power Off
- Mute Toggle
- Next Source

- Click the **Source Control Type** drop down and select **Discrete**. *The Controller Commands section in the Properties Pane now shows (Source 01) command name.*

Video Display : Projector

Name	Projector
System #	15015
Driver Version	7.1 Build 514.0 Rel
Device Type	Custom Video Display
On Off Control Type	Discrete
Source Control Type	Discrete
Delay After On/Off	100 msec
Delay After Source	100 msec
Volume Control	Yes
Mute Control Type	Toggle
Provide Local Sources	No
Provide Audio Return	No
Elan UltraMatrix ARP	No
Show as Zone	No

Controller Commands

- Begin Volume Up
- End Volume Up
- Begin Volume Down
- End Volume Down
- Power On
- Power Off
- Mute Toggle
- (Source 01)

- a. If more than 1 input on the TV is being used add additional sources to the video display in the system node tree. **Right click** on the (Source 1) node and select **Add New Source**.

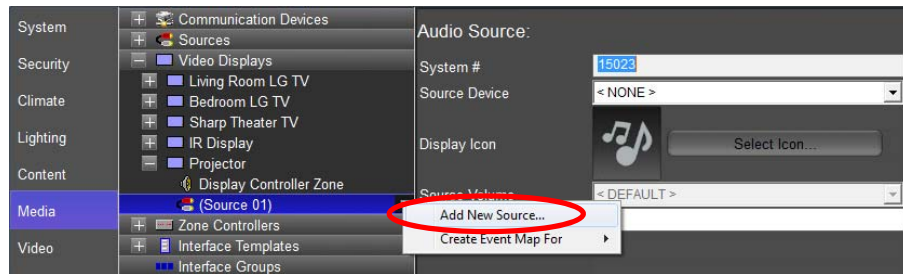

- b. In the Add New Source window **name the input** being used on the TV and select **OK**.

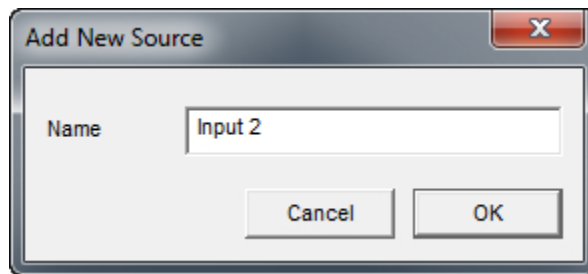

- c. (Source 2) appears below (Source 1). Verify that the Display Name is labelled correctly.

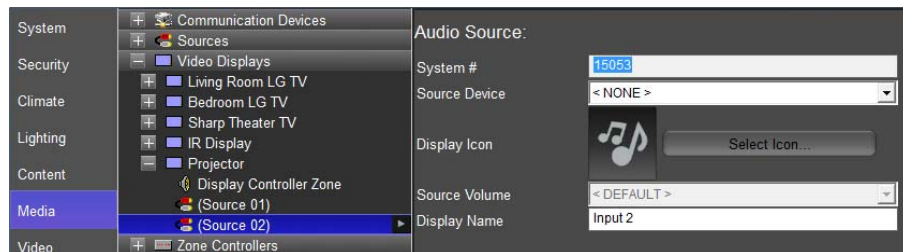

Note: The Display Name will only be shown in the gViewer if using the video display as a Generic Zone Controller.

- d. When finished adding sources, return to the **Video Display Properties** by selecting the **Projector** node.

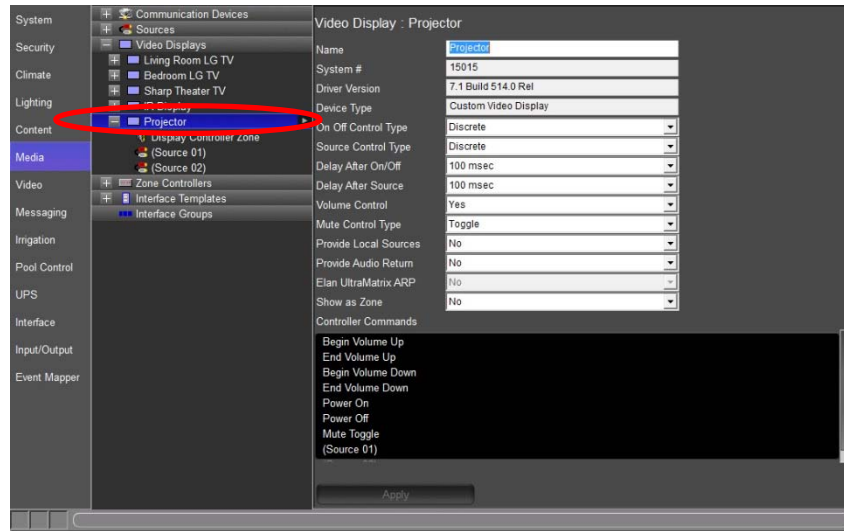

4. Make any adjustments from 100 msec to 14900 msec for the **Delay After On/Off** and **Delay After Source** delay times using the drop down arrow. *These adjustments can be made later if desired.*

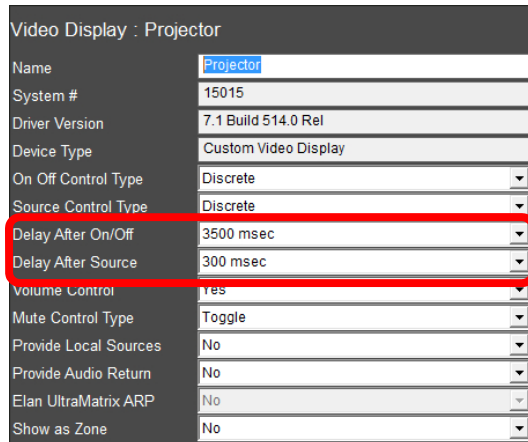

5. The **Volume Control** drop down may be set to **No** for this exercise. *The Mute Control Type field is greyed out and no longer able to be adjusted.*

Video Display : Projector	
Name	Projector
System #	15015
Driver Version	7.1 Build 514.0 Rel
Device Type	Custom Video Display
On Off Control Type	Discrete
Source Control Type	Discrete
Delay After On/Off	3500 msec
Delay After Source	300 msec
Volume Control	No
Mute Control Type	None
Provide Local Sources	No
Provide Audio Return	No
Elan UltraMatrix ARP	No
Show as Zone	No

6. **Mute Control Type** sets how the video display will use the mute command:
- Set to **Toggle** if there is a single command for mute that toggles between mute on and mute off.
 - Set to **Discrete** if there is a separate mute on and separate mute off command for the video display that is managed by g.
 - Set to **None** if there is no mute command for the video display.
7. The **Show as Zone** drop down should be set to **No** for this exercise.

Video Display : Projector	
Name	Projector
System #	15015
Driver Version	7.1 Build 514.0 Rel
Device Type	Custom Video Display
On Off Control Type	Discrete
Source Control Type	Discrete
Delay After On/Off	3500 msec
Delay After Source	300 msec
Volume Control	No
Mute Control Type	None
Provide Local Sources	No
Provide Audio Return	No
Elan UltraMatrix ARP	No
Show as Zone	No

8. Verify the Controller Commands section looks similar to the below image:



a. Select **Power On** from the Controller Commands section. *The Commands window appears.*

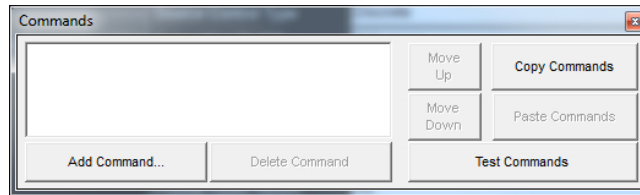

b. Click **Add Command**. *The Add Command window appears.*

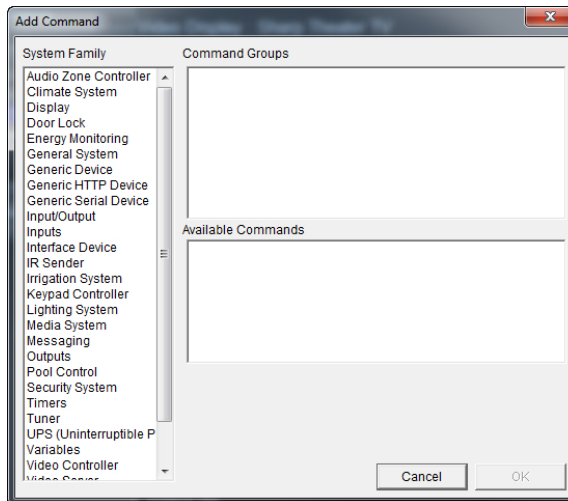

- c. In the System Family section of the Add Command window, locate and select the **Generic Serial Device**. *System Family* is where device commands are grouped for easy access in the Add Command window.

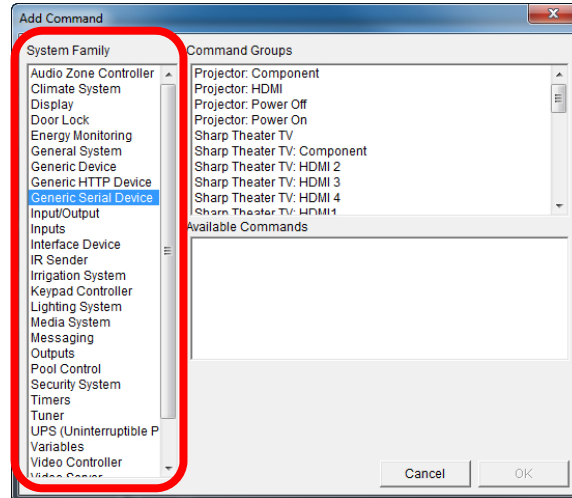

- d. In the Command Groups section, locate and select the power on command for the display. In this exercise use the **Projector: Power On** command. *Command Groups* displays the available commands for the selected System Family.

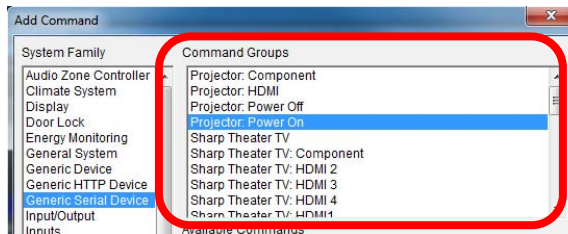

- e. In the Available Commands section, locate and select the **Send via Default Device** command. *The Available Commands shows what commands are available for the selected command group:*
- Send via Default Device:** Sends the command out of the previously assigned Serial Port.
 - Send via Device:** Sends the command out of a Serial Port that is different then what was previously assigned.

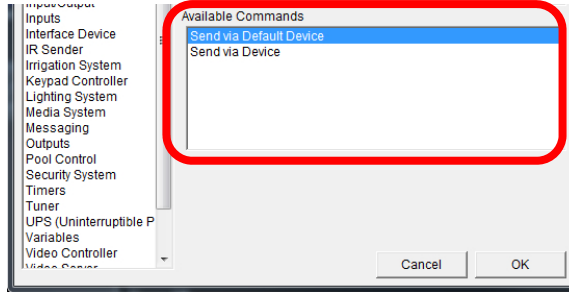

- f. Select OK to save the command and return to the Commands window. Your Commands window should look similar to below:

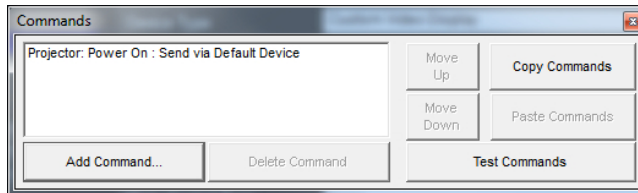

Repeat steps a thru f to add the Power Off, (Source 1), and (Source 2) commands. For more information on how to add a Video Display to a Media Zone review **Lesson 8: Home Theater, Exercise 8.**

Exercise 3: Import a Serial File from g!Tools for a Generic Serial Source

Overview In Exercise 3, you will import a serial code file from the Serial library in g!Tools to provide one-way serial control from the g! software. The steps outlined here will work much the same for importing Generic Serial Drivers created and exported from the g! software, except that g! files will include full Universal Function data.

In the following steps, you will add a Generic Serial Driver for a DVD Player. A DVD Player is a good candidate for one-way serial control as there is typically no feedback required.

How-to

1. In Configurator, navigate to the Media tab.
2. Right-click **Communication Devices** in the System Node Tree and select **"Add New Communication Device"**. *The Add New Communication Device window opens.* In the dialog box:
 - a. Enter **"Generic DVD"** as the Device Name.
 - b. **Communication Type** select **Standard Connection**.
 - c. **Hardware Type** select **Serial Port**.
 - d. Select an **Unassigned COM Port** in the **COM Port** drop-down box.

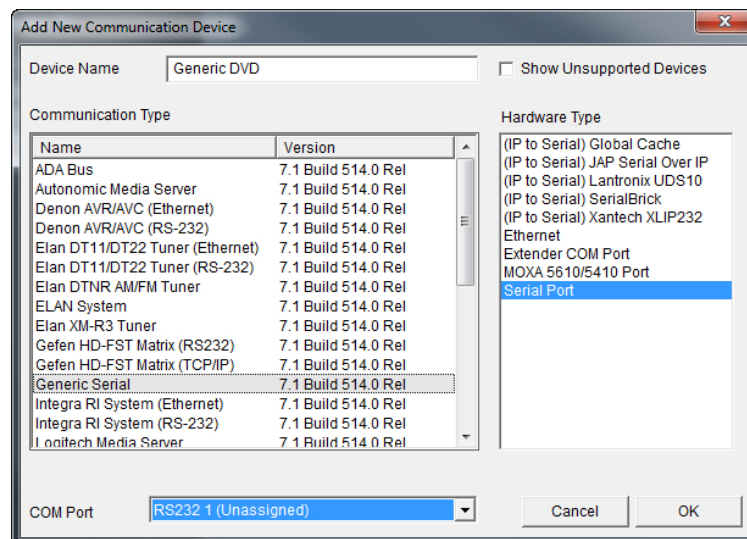

Note: Choose the COM Port the device is physically connected to on the g controller. Choosing the incorrect COM Port will result in the device not responding to commands for the g controller.

- e. Click **OK** when finished.

3. Right-click **Sources**, and select **Add New Custom Source....** *The Add New Interface window opens.*
4. Enter "Generic **DVD** " as the Interface **Name**, select **DVD Single Disc** from the Copy Layout from Template list, and select **Create New Serial Device**.

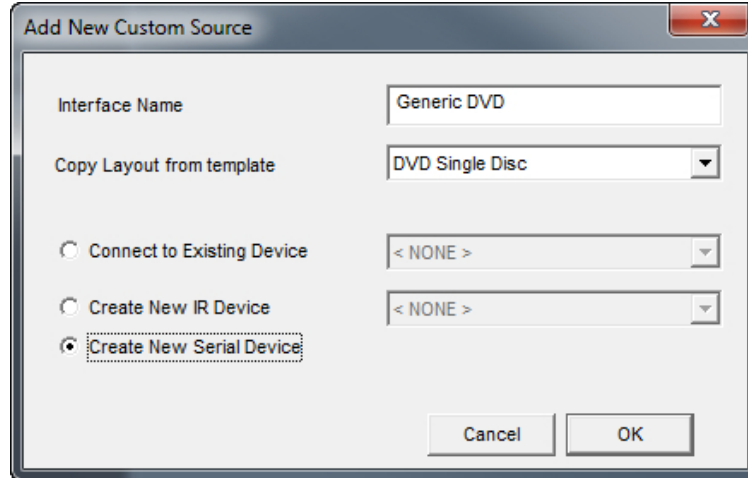

Interface Name: Generic DVD

Copy Layout from template: DVD Single Disc

Connect to Existing Device < NONE >

Create New IR Device < NONE >

Create New Serial Device

Cancel OK

5. Click **OK** when finished.
6. Click the (+) sign next to Generic DVD in the Sources node to expand it, then click the **Generic DVD** serial device to view its properties. Verify that the Generic DVD communication device added in Step 1 is linked to this serial device.

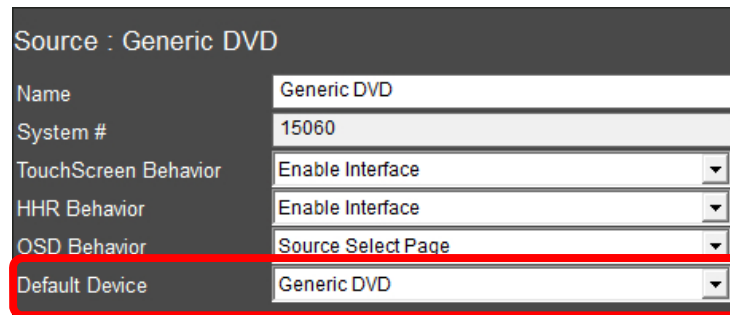

Source : Generic DVD

Name	Generic DVD
System #	15060
TouchScreen Behavior	Enable Interface
HHR Behavior	Enable Interface
OSD Behavior	Source Select Page
Default Device	Generic DVD

7. Click the **Generic DVD** under **Communication Devices** to verify the baud rate and other serial settings are configured correctly.

Name	Generic DVD
System #	5776
Device Type	Serial Port / Generic Serial
Location	< SELECT >
Enable Sharing	No
Sharing Port	0
COM Port	NONE
Protocol	RS232
Baud Rate	9600
Flow Control	None
Parity	None
Data Bits	8
Stop Bits	1

For this exercise we will assume the default settings are correct, but in a real install all the serial settings must **exactly** match those indicated in the serial protocol for the device for communication to be effective.

8. Import the serial codes. **Note:** The serial codes must be in **ELAN SC4_SER, HomeLogic HSR** or **ELAN .ESR** file format.
- To import a file, right-click on Generic **DVD Player** in the System Node Tree and select **Import Codes From File....** to open the Windows File Open Folder. *This folder opens directly into the g!Tools Serial Library directory.*
 - Browse to Pioneer\DVD and select the Pioneer BDP-LX55.HSR file as shown below to import the Pioneer DVD Player file.

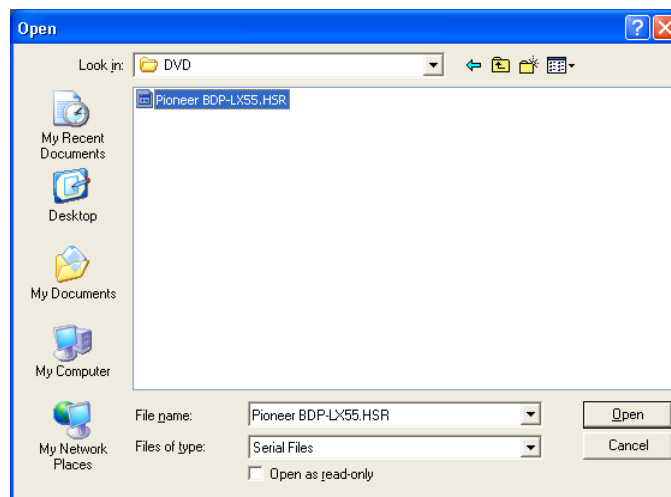

- c. For a few moments the g! software will read and interpret the settings saved in the file. Once finished, click the (+) symbol. You will see a list of codes displayed inside the Generic Serial Device: DVD Player in the System Tree.

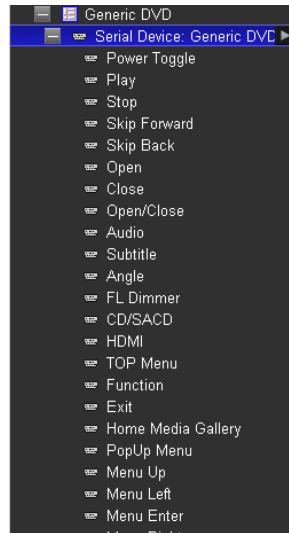

9. Once all the codes have been added, test them using the Test Code Now option. Right-click the code, and select **Test Code Now**.

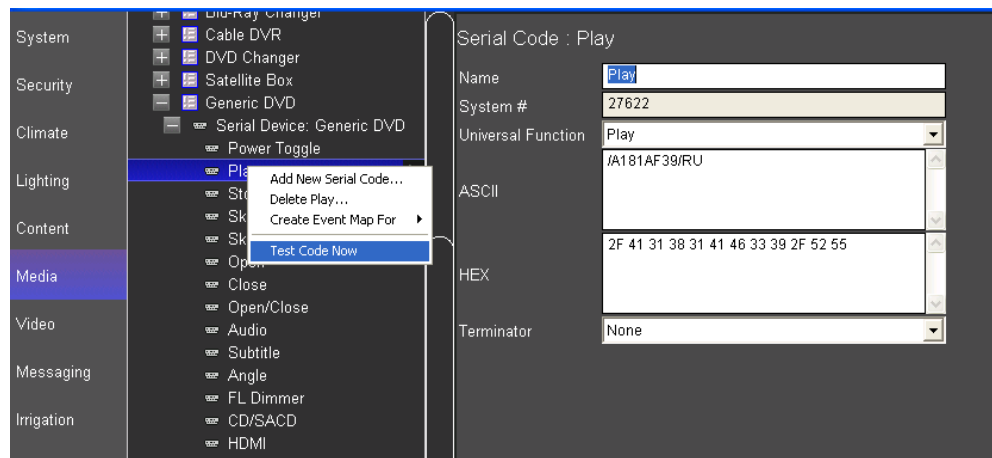

Note: Since actual equipment is not installed for this lesson, we cannot verify that the command is effective, but will assume it is valid. On a real install, testing codes can be very helpful when developing Generic Serial Drivers, and is an important part of the driver creation process.

10. Once you have verified that the imported codes work, it is a good idea to prepare them for use in an interface by checking Universal Functions.

Since these files were imported from the ELAN database, they do not natively save Universal Function information. The g! software attempts to match up Universal Functions for you automatically, but if the names of the codes in the imported serial files do not match a Universal Function, they will not auto-map.

Therefore, it is important to verify that all imported codes have Universal Functions set correctly after performing an import from ELAN.

- a. Scroll through the list and locate CD/SACD, this code does not align with any Universal Functions.
- b. Set the correct Universal Function now by clicking on the **Universal Function** drop down, scrolling down and selecting **Source CD**.

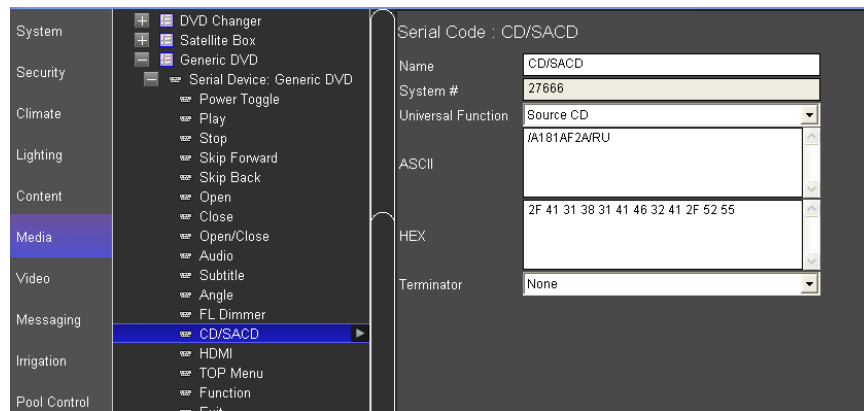

- c. Go through all the codes repeating steps **a** and **b** as necessary.

Notes about codes that do not match a Universal Function:

- Some codes, like **I_P Selector**, will not have a Universal Function in the g! software. You may leave these unmapped.
- Any commands you do not map Universal Functions to will **not** auto-map to an Interface.
- There are 20 "User" Universal Functions available for you to map any functions you wish to auto-map that are not in the g! software's default listing.

11. Now that the Serial Device has had all codes tested and optimized, and all proper mapping completed, it is a good idea to export a copy. The exported file can be imported again to this system, if you were controlling multiple identical devices, or imported to another system at a later date if you will reuse this device in a future job.
12. Right-click the **Serial Device: Generic DVD** and select **Export to File** from the menu to open the Export Serial dialog box.

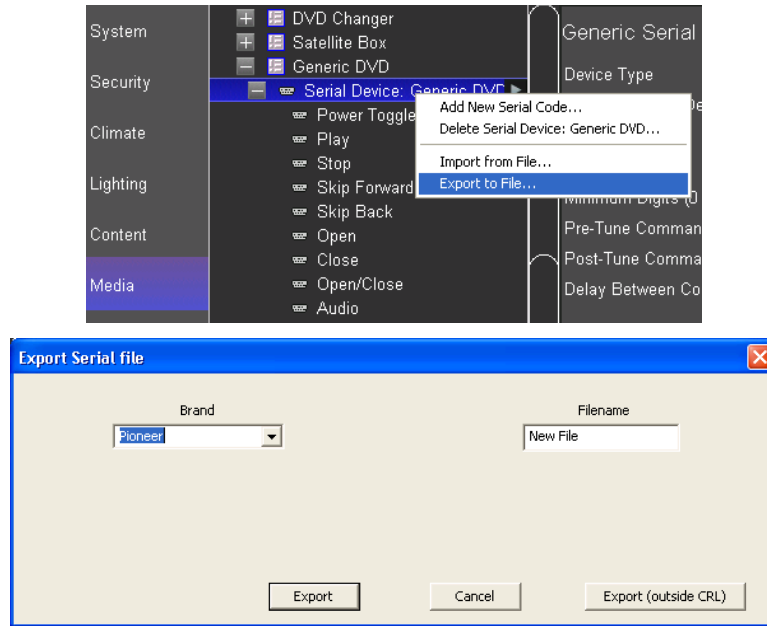

13. Select the brand from the list, and name the file. Then, click Export to save the file in g!Tools. Otherwise, click the Export (outside CRL) button to navigate to a folder on your PC where you would like to save the file. For this exercise, select the Pioneer folder in g!Tools as shown above.

Note: g!Tools installs the data files into a hidden directory. You may need to select “show hidden files and folders” from your explorer folder options dialog box to be able to browse directly to it. Alternatively you can create a shortcut on your desktop to the directory to access the folders.

14. In the **File Name** field, type “**DVD Player**”, then click **Save**.

Note: Saved file names should be as descriptive as possible and include manufacturer, model number and device type so that they will be easy to find the next time you need them.

Exercise 4: Add the Interface for Generic Serial-controlled Source

Overview When you add the new Generic Serial Device on the Media tab, the system adds both the codes and the interface under the Sources node. Verify that the graphical layout of buttons and other elements for the control of the device from a touch screen.

How-to

1. Verify that mapping was effective for the default device. Click on the Generic **DVD Player** in the One-Way Devices list and verify the default device is set to Generic DVD.

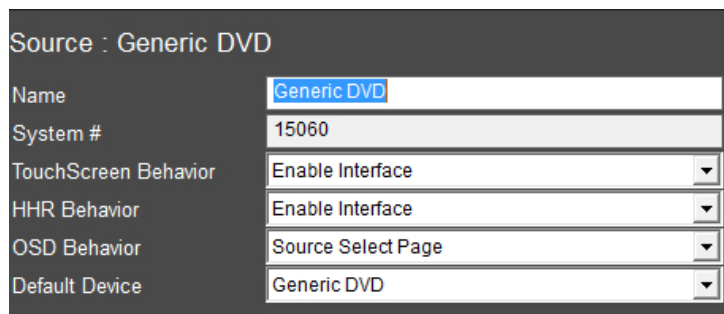

2. Click the + next to Generic **DVD Player** in the System Node Tree and select **Large Format, Large Landscape Standard** layout to preview the Generic DVD interface.

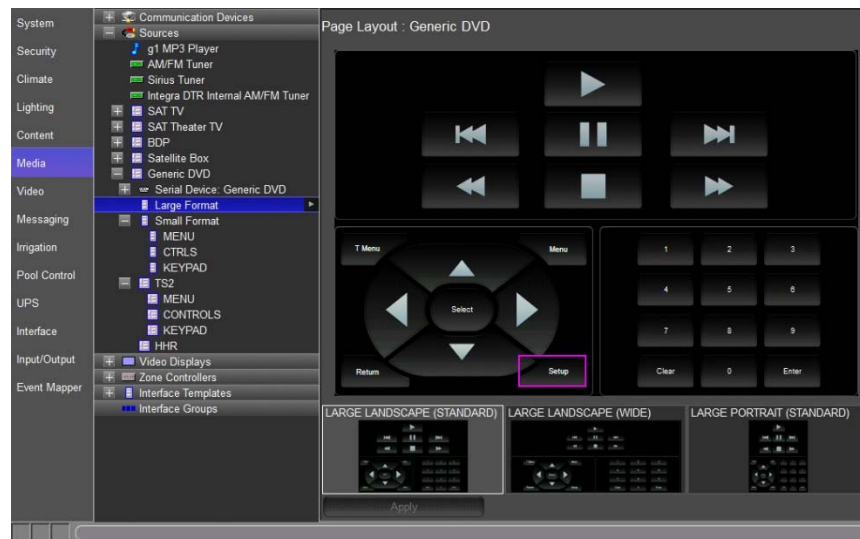

Note: A Purple box around a button indicates there is no command code assigned to the button. This is caused by mismatched Universal Function assignment or from missing command codes.

- Click the **Menu** button in the interface to display the buttons properties. Verify the **Universal Function** selection is set to **Menu**. *When this button is pressed in the Viewer the Menu command for this interfaces default device will be issued*

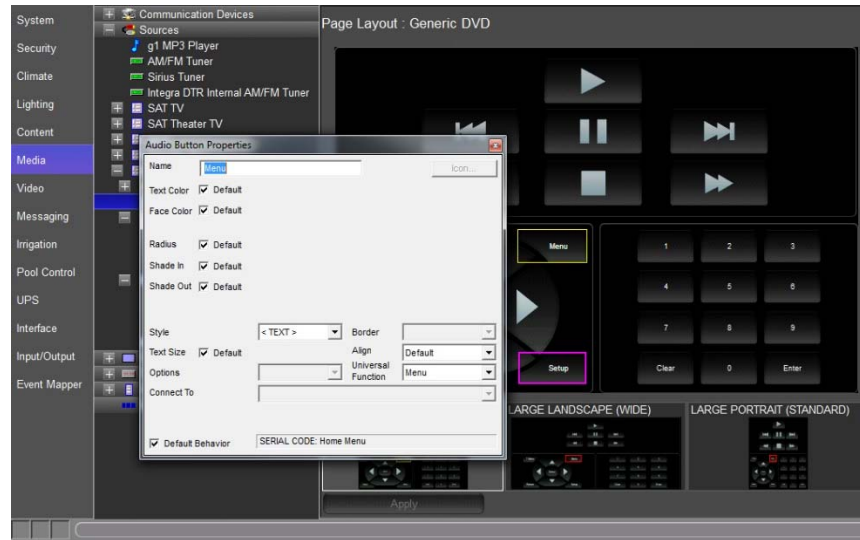

- Repeat to verify additional commands.

Lesson 11

Configuring Video



Overview

This lesson shows you how to configure IP video cameras and servers to provide live video to any connected Viewer.

You will:

- Learn how video cameras are organized in the Configurator.
- Use the Configurator to set up video cameras.
- Check the Viewer interface to confirm proper configuration.

Sample House

Our sample house will be configured with two video cameras:

- Backyard: Pan/Tilt IP camera
- Front Door: Analog camera connected to the g! software with an IP Video Server

Requirements

- A g! system controller and g!Tools.
- ELAN IP Camera(s)
- Panasonic IP Camera(s)

Video Overview

Overview The following diagram shows two video sources in a basic system schematically. The diagram includes the components that are important to the ELAN controller.

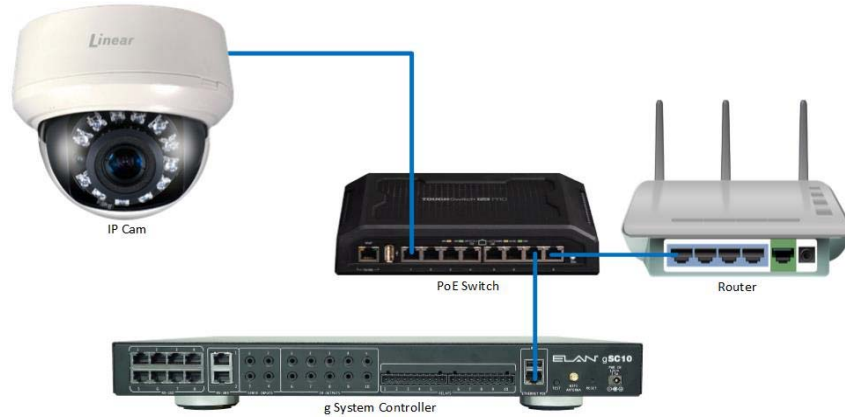

Terms The following terms are used in the **Configurator**:

- **Communication Device:** Most video devices do not require a communication device, but in a few cases they will. Refer to the video devices integration note for details:
 - IP cameras do not require a communication device, the communication information is contained within the Video Camera setup in the Configurator.
 - Some video servers do require a communication device. In this case the network communication information is configured in the communication device. Check the video server Integration Note for details.
- **ONVIF™** - Specification aimed at standardizing the network communication framework for network video products, including IP cameras.
- **Video Camera/Source:** This is the camera/source itself. It can be an IP-based network camera or an input port on a video server.

How-to To integrate video cameras:

- Add the **Communication Device** (if applicable)
- Add the **Video Cameras**

Exercise 1: Add a Single IP-Based Network Camera

Overview In the following steps you will add a Panasonic IP-based network camera. IP cameras do not require a communication device, you will only need to add the camera and enter the required information for communication over the network.

How-to

Note: All IP cameras must be configured properly prior to integrating with the g! software. Refer to the *Integration Note* for the specific camera used for required camera setup steps.

1. In the **Configurator**, click the **Video** tab, then right-click **Video Cameras/Sources** in the System Tree, as shown below.

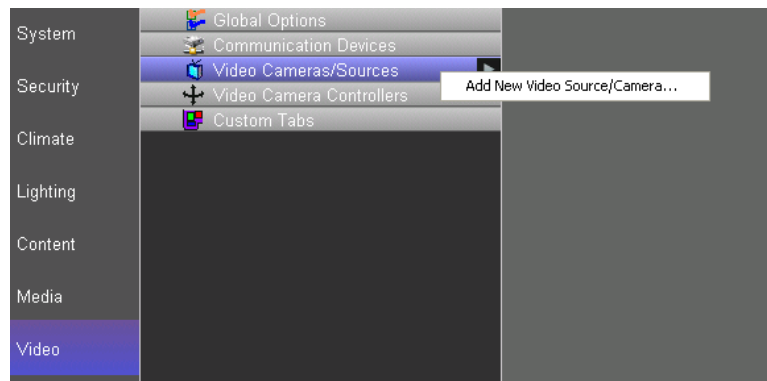

2. Click **Add New Video Source/Camera....** The *Add New Video Source/Camera* window opens.
3. Select **Panasonic Standard Series** from the Device Type list. Name the camera "Back Yard", and then click **OK**.

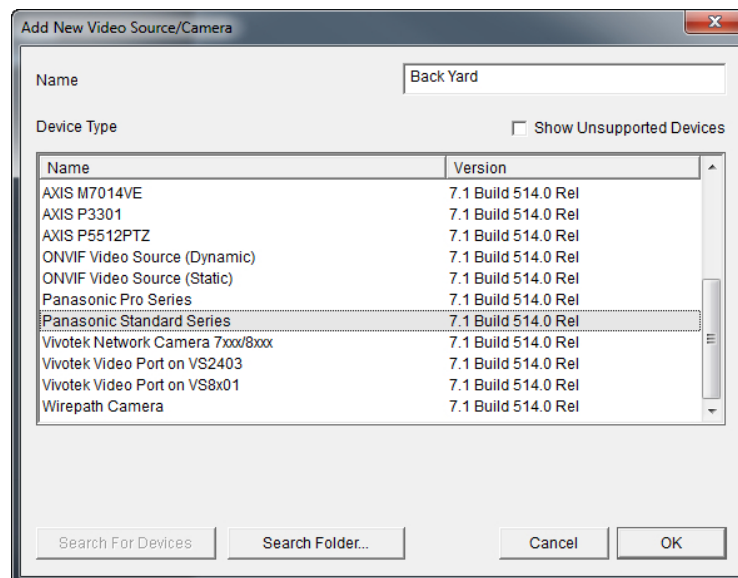

4. Select the Back Yard camera in the System Tree and enter the following required information for communication in the properties window:
 - a. Enter the camera's **IP address**.
 - b. Enter the camera **login username** and **password**. (if required)
 - c. Select **Yes** for each option that your IP camera supports and you wish to enable in the g! software.
 - d. Click **Apply**.

Video Source/Camera : Back Yard	
Name	Back Yard
System #	14978
Driver Version	7.1 Build 514.0 Rel
Device Type	Panasonic Standard Series
IP Address	192 . 168 . 0 . 0
Port	80
UserName	Administrator
Password	password
Has Pan/Tilt	Yes
Has Zoom	Yes
Has Presets	Yes
Has Audio	No
Has Motion Detect	No
Flip Image 180	No
Hide Full Screen Control	No
Hide Resolution Control	No
Default Resolution	Auto
Goto Preset when Idle	< NONE >
Enable DVR	No
Record Resolution	< SELECT >
Record Mode	Auto (Medium Sensitivity)
Record Threshold	0%
Minimum Rate	1/60sec
Apply	

Exercise 2: Add an ONVIF™ IP Camera

Overview In this exercise, you will configure an ELAN IP camera using the ONVIF™ driver. The driver supports all ONVIF IP cameras.

Before configuring the ONVIF IP camera ensure that the unit is properly configured and operating correctly on the network.

How-to Add an ELAN IP Camera using the ONVIF™ driver.

1. On the **Video** tab, select **Video Camera/Sources**. Right-click and select **Add New Video Source/Camera**. *The Add New Video Source/Camera window opens.*
 - a. Name the device **“Front Door”**
 - b. Select **Device Type** as **ONVIF Video Source (Static)**
 - c. Click **OK**.

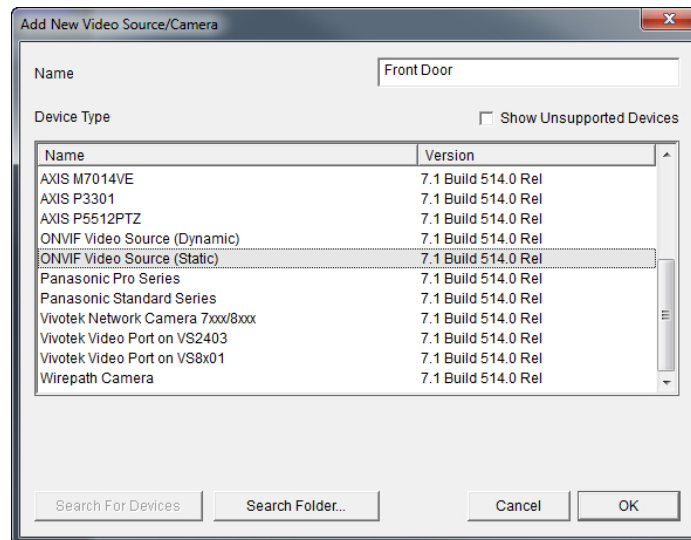

2. Navigate to the newly added node, Front Door for this exercise, and enter the following information:
 - a. Enter the **IP address** of the ONVIF IP camera in the URL field.

Video Source/Camera : Front Door

Name	Front Door
System #	14987
Driver Version	7.1 Build 514.0 Rel
Device Type	
URL	http://192.168.0.80/onvif/device_service
UserName	
Password	
Flip Image 180	No
Hide Full Screen Control	No
Goto Preset when Idle	< NONE >
Enable DVR	No
Record Resolution	< SELECT >
Record Mode	Auto (Medium Sensitivity)
Record Threshold	0%
Minimum Rate	1/60sec

ONVIF Settings

- b. Enter the camera **Username** and **Password**. (if required)

Video Source/Camera : Front Door

Name	Front Door
System #	14987
Driver Version	7.1 Build 514.0 Rel
Device Type	
URL	http://192.168.0.80/onvif/device_service
UserName	admin
Password	admin
Flip Image 180	No
Hide Full Screen Control	No
Goto Preset when Idle	< NONE >
Enable DVR	No
Record Resolution	< SELECT >
Record Mode	Auto (Medium Sensitivity)
Record Threshold	0%
Minimum Rate	1/60sec

ONVIF Settings

- c. Set any additional settings if desired for the ONVIF cameras.
 - d. Select **Apply** when finished.

3. Set the ONVIF Settings for use with a TS7/TS10/VL10:

- a. Click the ONVIF Settings button below the Minimum Rate drop down. *The ONVIF Settings window opens.*

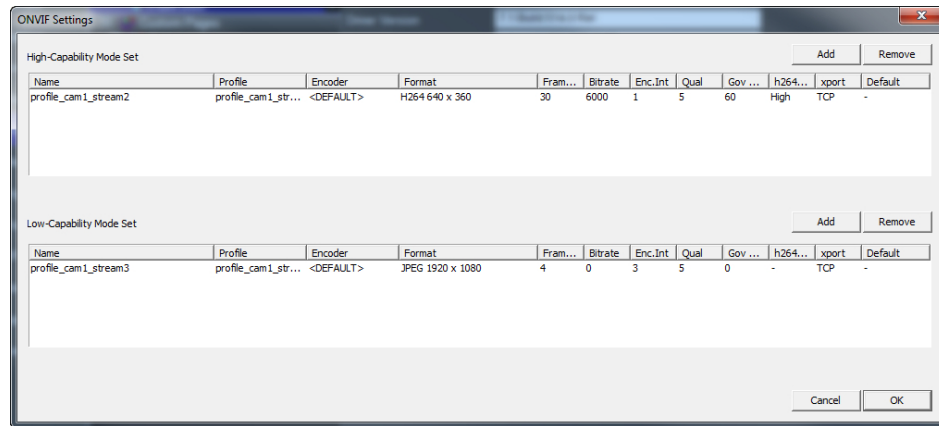

Note: The gTP7 touch panel supports the H264 video codec for IP Cameras. The motion JPEG settings apply to TS7/TS10/VL10 touch panels and when using the g!DVR feature. Refer to the *Integration Note* for the ELAN g!DVR for additional information.

- b. Ensure the Low-Capability Mode Set column **Encoder** is set to **Stream 3**.
- c. Set the **Format** column to **JPEG 640 x 360**.

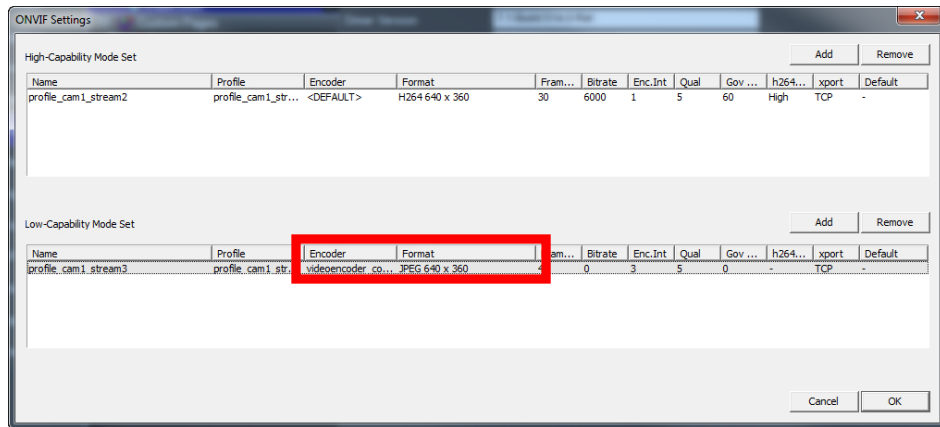

- d. Click **OK** when finished.

Note: The ONVIF Settings differ between manufactures. Examples shown are from ELAN's ONVIF IP Cameras. Video streams for the ELAN IP Cameras may also be setup using the included software. All IP video servers must be configured properly prior to integrating with the g! software. Refer to the *Integration Note* for the ELAN IP cameras for additional information.

Exercise 3: Add an Analog Video Camera

Overview In this exercise, you will configure an AvioSys IP Video Server. This video server has four analog video inputs to convert video from up to four analog video sources to be viewed on the Viewer interface. You will first add a communication device and then add one port (video input) on the video server that the g! software uses to display the video.

How-to

Note: All IP video servers must be configured properly prior to integrating with the g! software. Refer to the *Integration Note* for the specific video server used for required server setup steps.

4. Add the video server communication device. On the **Video** tab, select **Communication Devices**. Right-click and select **Add New Communication Device**. *The Add New Communication Device window opens*
 - a. Name the device "Video Server" then click **OK**
 - b. Select **Ethernet** as the **Type**.
 - c. Select **AvioSys IP Video 9100B** as the **Communication Type**.
 - d. Click **OK**.

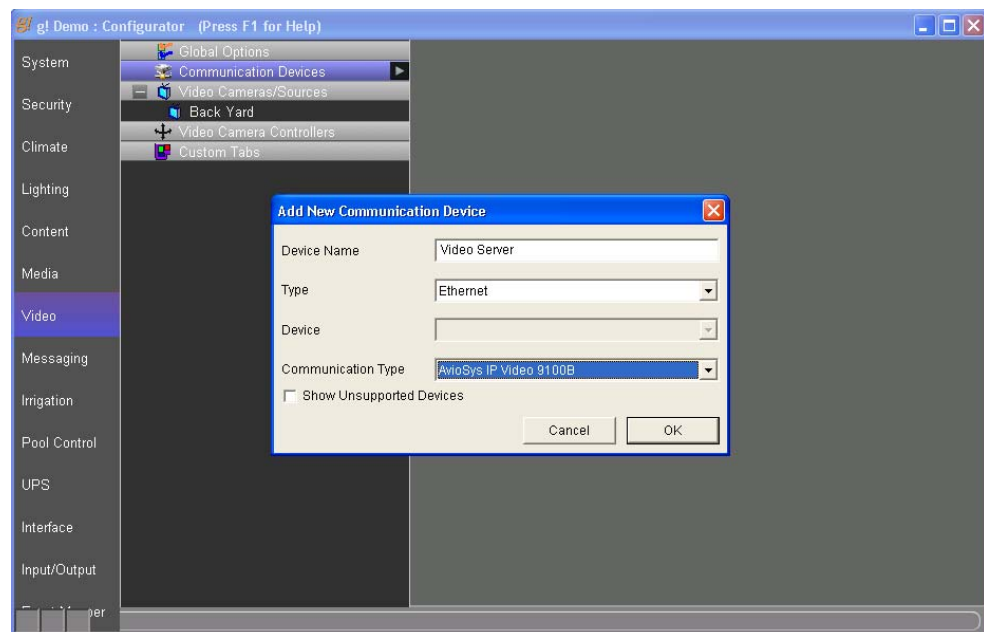

5. Enter the required information for communication. Click on the **Video Server** communication device in the system tree and enter the following information:
 - a. Enter the video server's IP address.
 - b. Enter the camera **login username** and **password**. (if required)

Note: When following this exercise in a training this information may be left blank. In an actual system using IP Cameras the Login Username and Password **MUST** be entered.

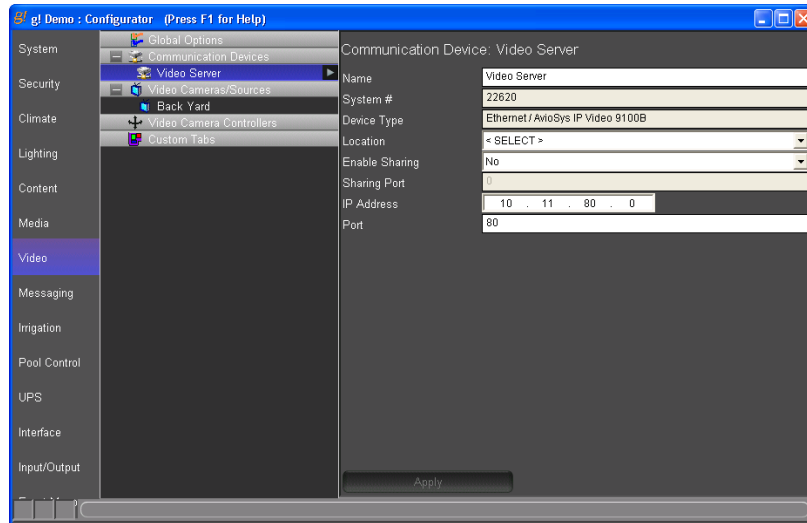

6. Add the video server port:
 - a. On the **Video** tab, select **Video Cameras/Sources** on the system tree. Right-click and select **Add New Video Source/Camera**. *The Add New Video Source/Camera window opens.*
 - b. Select **AvioSys Video Port** from the list
 - c. Set the name to "Front Door" and click **OK**.

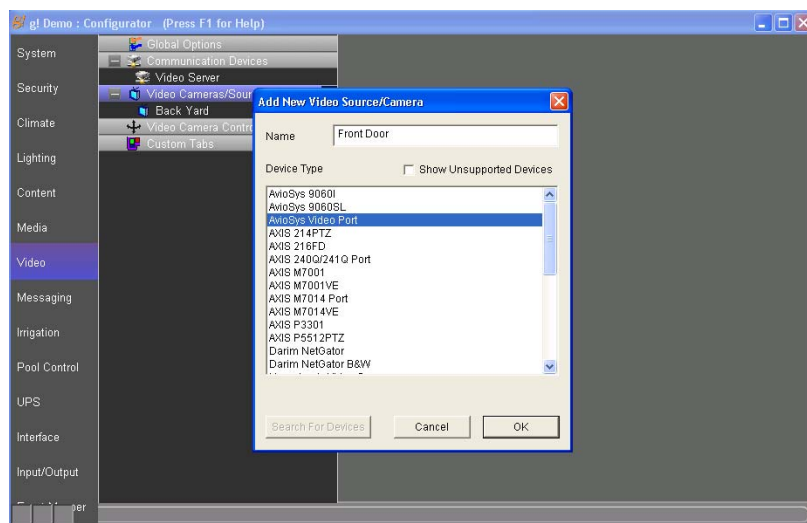

7. Edit the properties for the video source:
 - a. Click the Front Door camera in the system tree to view the camera properties window.
 - b. Confirm the **Communication Device** is set to **Video Server**,
 - c. Set the **Video Source** to **1**. *This defines the input port on the server to which the video is connected.*
 - d. Click **Apply** at the bottom of the screen.

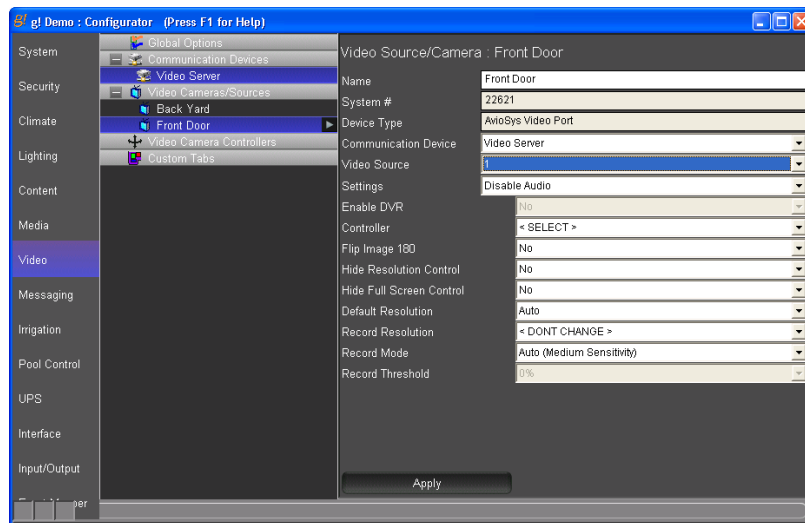

Exercise 4: Check the Viewer Interface

How-To Once you have configured the two video cameras, check the Viewer to confirm your work.

1. From the g!Tools My Systems screen, click the **Viewer** button.
2. Click **g!** in the upper left to access the main system icons, then click the **Video** icon to access the available video streams. You will see two icons; one for each camera. Select each one and notice the differences.

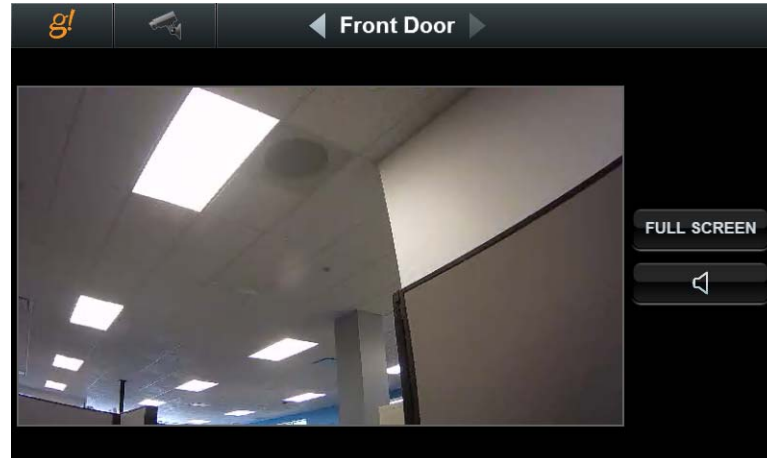
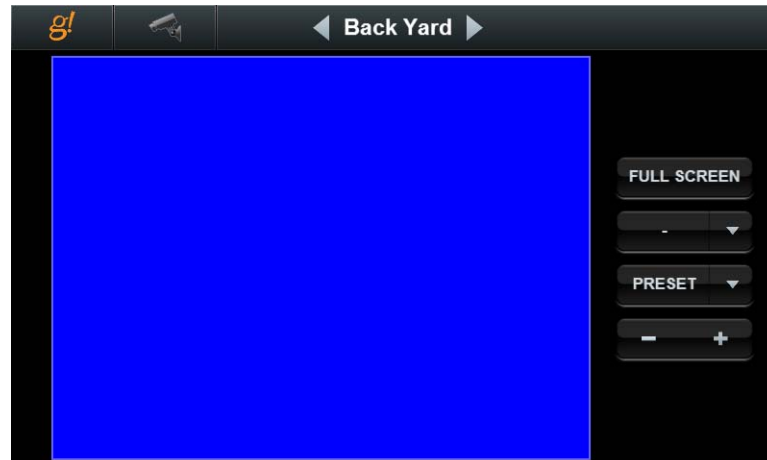

- For cameras with Pan / Tilt capability, you can click anywhere in the video image to re-center the camera view on that spot.
- For cameras with zoom, +/- buttons display to allow you to zoom in or out.
- For cameras with audio, icons display at the bottom right for control of the audio volume level.
- For cameras that allow Presets, a series of numbered Preset buttons are displayed. To save a new preset move the camera to the desired new location, press and hold the preset # to save the new view.

Sample screenshot from an IP camera that supports Pan, Tilt, Zoom, Presets and Audio:



Lesson 12

Messaging



Overview

The g! software Messaging feature is used to provide phone answering service, including voice mail boxes where users can receive voice messages from incoming phone calls, or leave messages to each other from touch screens within the home.

The phone answering service also allows remote access of messages over a standard phone line. In addition, Messaging features are used for transmitting alerts via e-mail or text message based on system events.

You will:

- Learn how to setup your compatible g! system controller for phone features.
- Learn how to use and configure voice mail features.
- Learn how to send alerts based on system events.

Requirements

- g! system controller and g!Tools.
- gMOD – USB to Phone Modem
- Active phone line

Messaging Overview

Overview The Messaging tab can be used to provide a Voice Messaging features to the Home Owner by using a modem to integrate with the phone line. Voice mail messages and call logs can be accessed through the g! Viewer. The messaging tab also can be used to send alerts via e-mail or text messages to multiple contacts based on system events.

Terms

- **Telephone Controller** – The software component to use the modem for interfacing with the phone line
- **Voice Mail Boxes** – The individual mail boxes where voice mail can be recorded either from the phone or at a touch screen.
- **E-Mail Messages (Outbound)** – Customizable e-mail messages that can be sent to system contacts based on system events.
- **Greeting** – Message played to incoming callers prior to voice mail recording.

How-to To integrate messaging features:

- Add the **Telephone Controller** so the g! software will interact with the phone line
- Configure **Telephone Controller** options such as login pin for remote access via telephone
- Configure a **Voice Mail box** for each anticipated user
- Setup **Greeting** options in the Viewer

Exercise 1: Configure Messaging

Overview In this exercise we will set up phone and voice mail features. This exercise will involve creating a framework in the Configurator so that features may be used and customized in the Viewer.

How-to

1. Open **Configurator** and click on the **Messaging** tab.
2. Right-Click **Telephone Systems** and choose **Add New Device...**, then add a **Telephone Controller**.
3. Configure Internal Telephone Controller options as desired:

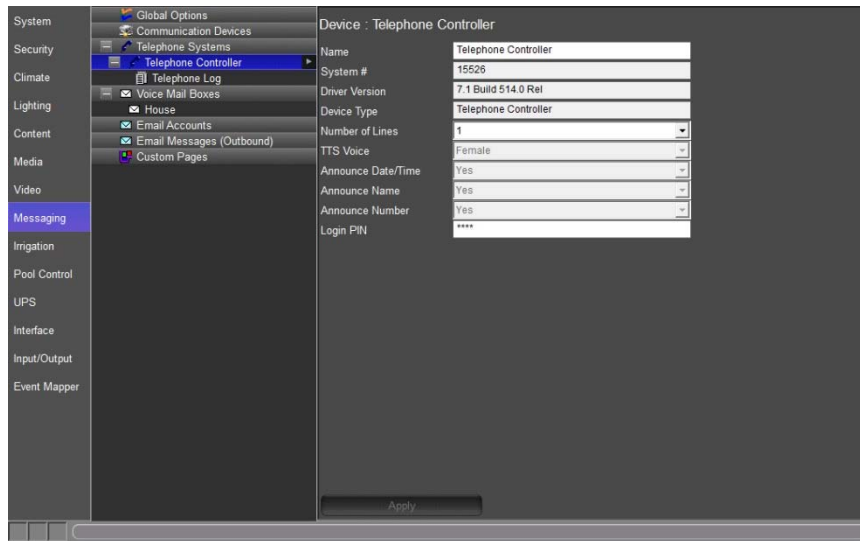

Quick Reference	
Name	Desired name of telephone controller
Number of Lines	Number of active phone lines. GMOD support up to 2 phone lines.
Login PIN	Set a numerical pin which can be used to login to the system and access messages over the telephone.

4. There is an existing 'House' Voice Mail Box, and this will be used as the default "catch-all" for the system. Add another Voice Mail Box:
 - a. Right-click **Voice Mailboxes** in the System Tree, and select **Add New Mailbox...**
 - b. Type a name for the new mailbox. (Example: Kids)

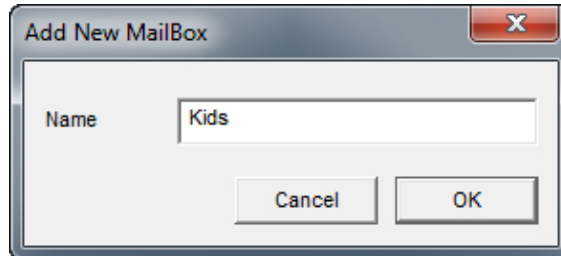

5. The new Voice Mail Box will be setup in the g User Interface in **Exercise 3.**

Exercise 2: Configure Messaging Alerts (Email)

Overview Alerts can be sent out by the system to specific contacts based on certain system events, such as a security alarm, a temperature reading, or even a certain A/V zone being activated after a certain time. These alerts can be sent as text via e-mail messaging. The alert messages themselves can be customized and support the use of “tokens” to include specific system details. In the following exercise, email alerts will be used to contact the home owner in the event of a burglar alarm sounding.

Note: Email Alerts do not require the use of the gMOD, USB to phone modem.

How-to

1. **Set up Users with email addresses on the User Settings page in the Viewer.** If you already entered an email address for a contact as part of Lesson 2: Configurator Overview, you may skip this step.

Add or edit an existing user and enter the email address. For example:

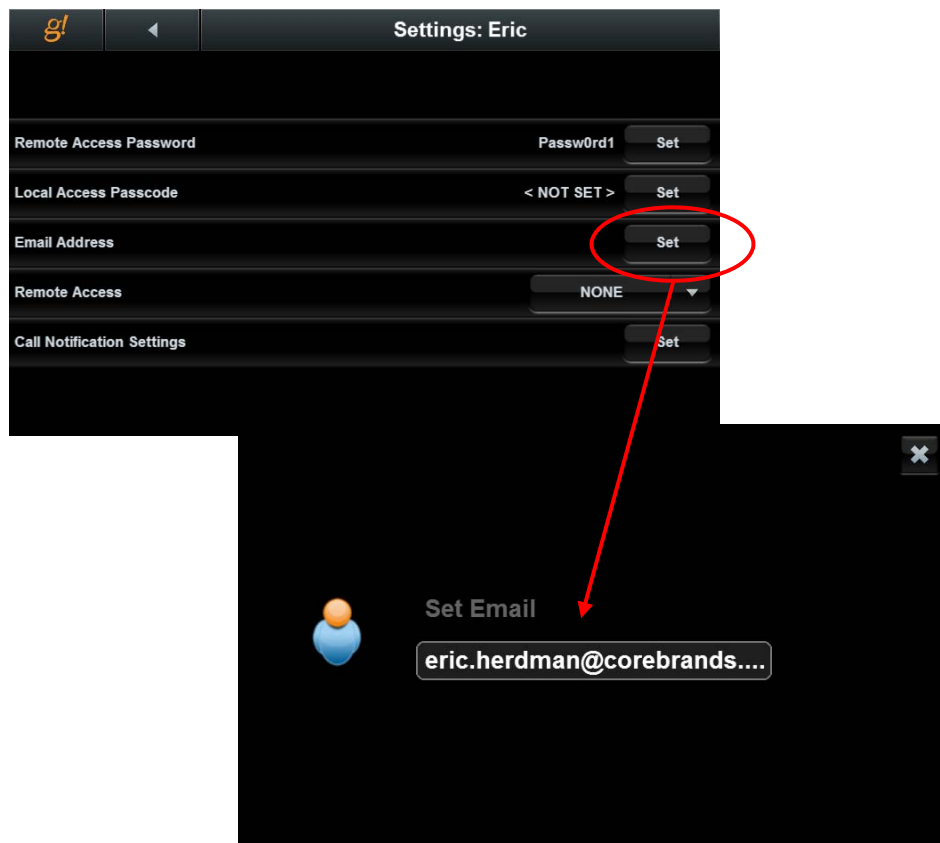

2. **Configure an outgoing SMTP server on the Messaging tab in Configurator.**

- a. Select **Global Options** in the Messaging Tab.

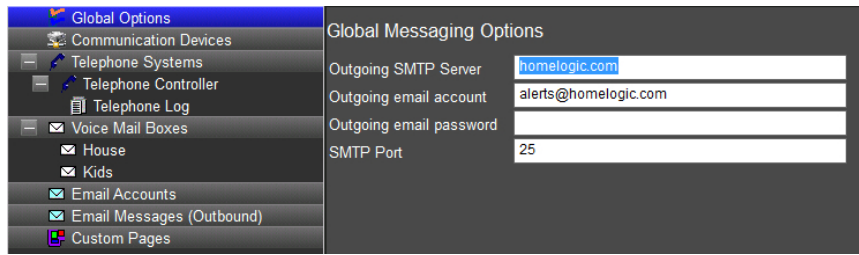

Quick Reference: Global Options	
Outgoing SMTP Server	The address of the sever for sending email.
Outgoing email account	The username of the email account being used to send email messages. Typically the email address of the account.
Outgoing email password	The password used to access the email account.
SMTP Port	The port number used to communicate with the SMTP server for sending emails.

- b. Enter the **address of the SMTP Server** in the **Outgoing SMTP Server** field. This information is generally provided by the email provider.
- c. Enter the **email account** in the **Outgoing email account** field. This is typically the email address.
- d. Enter the **email password** in the **Outgoing email password** field.
- e. Enter the **port number** in the **SMTP Port** field. This is information may be obtained by the email provider.

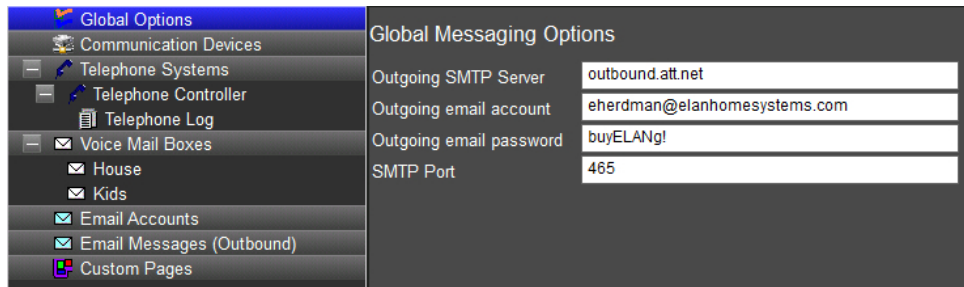

- f. Select **Apply** when finished.

3. Create an **Email Message (Outbound)**:

- a. **Right-Click** Email Messages (Outbound) and select **Add New Email Message**.
- b. Enter the name **Security Disarmed** in the Add New Email Message window.

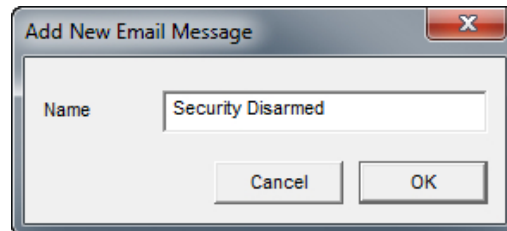

- c. Select **OK** when finished.

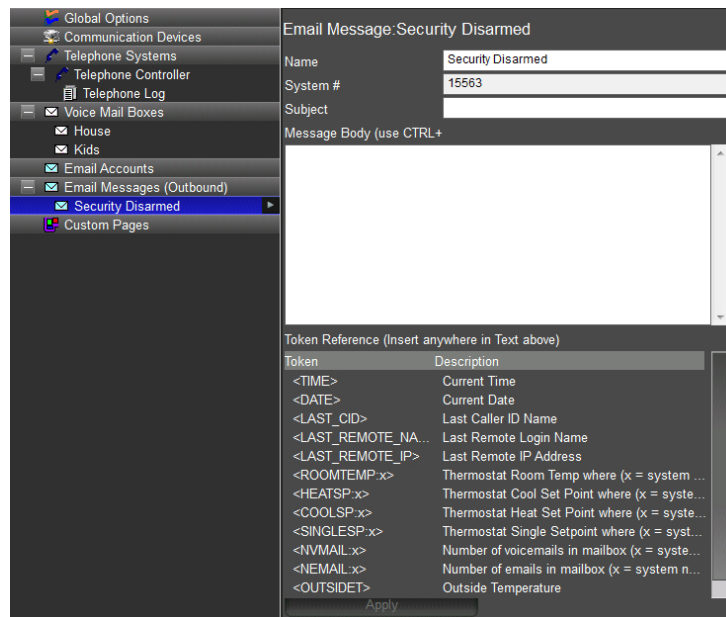

- d. In the **Subject** field enter **Alarm Disarmed**. adsfasfas
- e. Enter **"The security system has been disarmed."** In the **Message Body**.

- f. Enter the **Time** and **Date** Token References. This will put the time and date the message was sent in the message body.

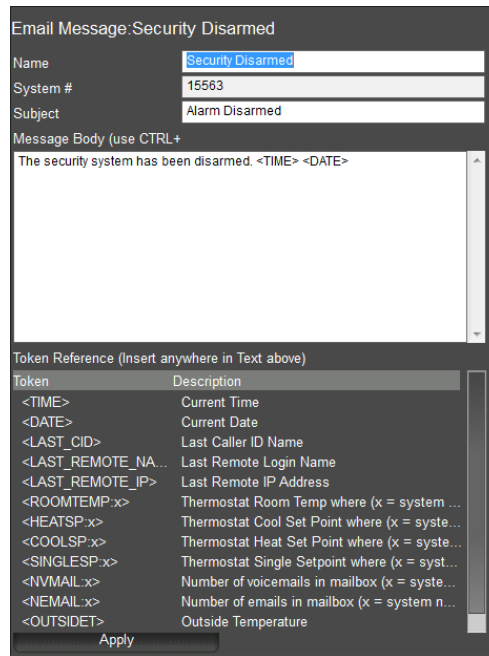

- g. Select **Apply** when finished.
4. Create an Event Map to set the controller to send the message when a specified system event occurs.
 - a. Navigate to the **Event Mapper** tab, **right-click** Event Maps and select **Add New Event Map**.

Note: ELAN recommends naming all your messaging alert event maps with the prefix *Alert:* to keep them organized.

- b. Name the new event map **Alert:Security** and select **OK**.

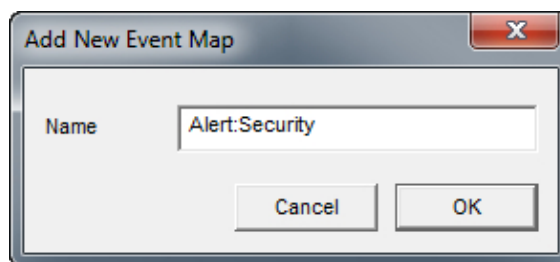

- c. In the **Events Row**, add an Event to trigger sending the email.
 - i. System Family: **Security System**
 - ii. Event Groups: **House**
 - iii. Available Events: **Disarm**

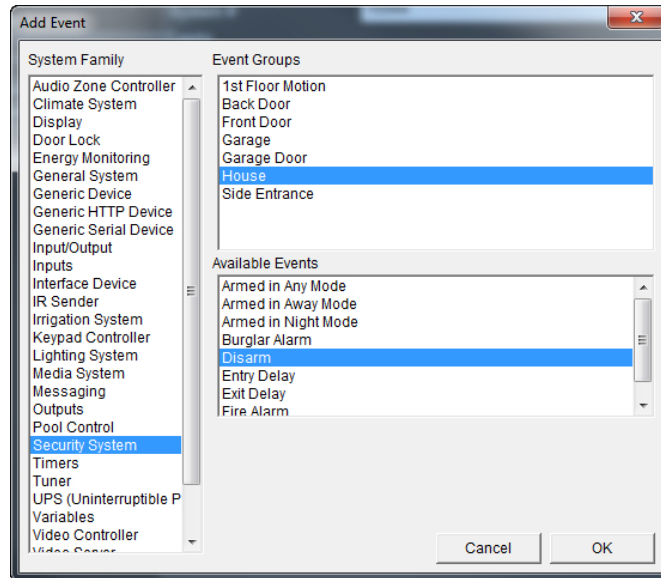

- d. In the **Commands Row**, add a command to send the email to a specific contact.
 - i. System Family: **Messaging**
 - ii. Event Groups: **Contact: Eric**
 - iii. Available Events: **Send Email**
 - iv. Options: **Security Disarm**

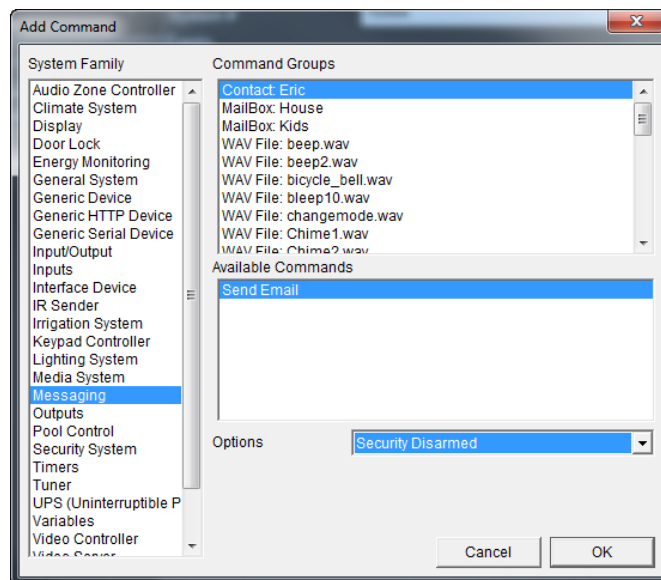

In this example, we are sending our Security Disarmed email message to our contact Eric when the Security system is disarmed. **Repeat step d** to add additional contacts to this event.

Exercise 3: Setup Email Account

Overview It is possible with the ELAN g system to view text based emails. In this exercise, we will explore how to setup an email account in the Messaging tab for viewing in the g!Viewer.

Note: ELAN g! only supports viewing of text based emails. HTML emails and images in emails will not be displayed in the g!Viewer.

How-to

1. Set up an **Email Account** in the Messaging tab.
 - a. Right-click on the **Email Accounts** node and select **Add New Email Account**.
 - b. In the **Add New Email Account** pop up window **enter the name associated with the Email Account**. For this exercise enter **Home**.

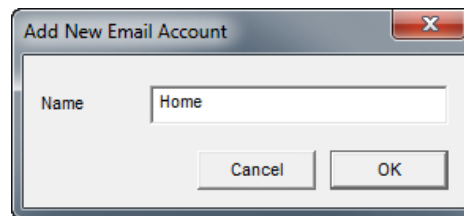

- c. Select **OK** when finished.

Email Account: Home	
Name	Home
System #	15565
POP3 Server	
POP3 Port	110
POP3 SSL	No
POP3 User Name	
POP3 Password	
Check Every	5 Minutes
Save Emails for	7 Days
Delete messages from server	No

Quick Reference: Email Account	
Name	Sets the name for the Email Account.
System #	Unique, read-only number assigned by the g! software for internal use.
POP3 Server	POP3 email providers server address
POP3 Port	Port used by email provider
POP3 SSL	Secure Sockets Layer protocol used for managing the security of a message transmission on the Internet.
POP3 User Name	User name of the email account. Typically the email address.
POP3 Password	The password used to access the email account.
Check Every	How often g will check the POP3 server. The g system can check the POP3 server every Minute, 5 Minutes, 15 Minutes, 30 Minutes, or 1 Hour.
Save Emails for	The length of time an email is saved on the g!Viewer. This setting can be from 1 day to 29 days.
Delete messages from server	Sets whether deleting an email message from the g!Viewer will also delete the email message from the POP3 server.

- d. Set the **POP3 Server** to match the information **provided by the ISP** being used in the project. For this exercise enter **inbound.att.net**.
- e. Set the **POP3 Port** to match the information **provided by the ISP** being used in the project. For this exercise enter **995**.
- f. Set the **POP3 SSL** to Yes or No depending on the information **provided by the ISP** being used in the project. For this exercise enter **Yes**.
- g. Set the **POP3 User Name** to match the **email address** being used in the project. For this exercise enter **sellIELANg@att.net**.
- h. Set the **POP3 Password** to match the **email account** password. For this exercise enter **sellinghappy**.

- i. Set **Check Every** to the desired amount of time that the g! system checks the POP3 email server for new email messages. For this exercise enter **Hour**.
- j. Set **Save Emails for** the desired amount of days that the client wishes the emails to remain on the g!Viewer. For this exercise enter **5 Days**.
- k. Set **Delete messages from server** to the desired setting for when an email message is deleted from the g!Viewer. For this exercise enter **Yes**.
- l. When finished click **Apply**.

Email Account: Home	
Name	Home
System #	15565
POP3 Server	inbound.att.net
POP3 Port	995
POP3 SSL	Yes
POP3 User Name	sellELANg@att.net
POP3 Password	sellinghappy
Check Every	Hour
Save Emails for	5 Days
Delete messages from server	Yes

Exercise 4: Check the Viewer

Overview In Exercise 1 we set up the framework for voice messaging in Configurator. In this exercise, we will explore voice messaging features.

How-to

1. Start the Viewer, click the **g!** icon to access the main menu, then click messaging icon to access the various messaging options.

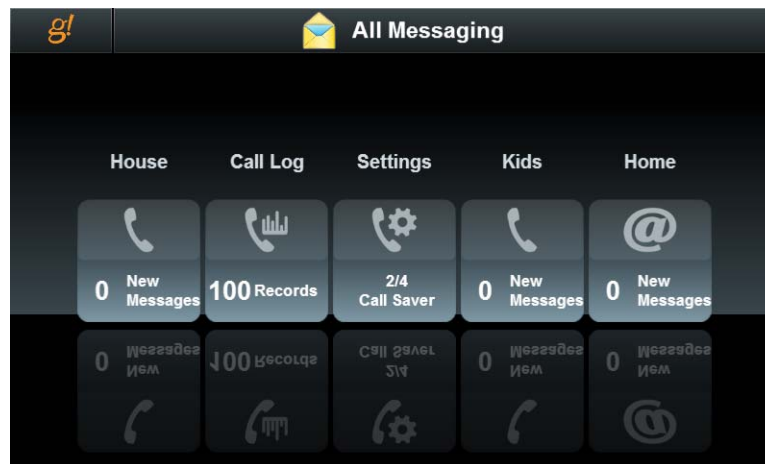

The screen displays available messaging options:

- The House Voicemail box
 - The Kids Voicemail box
 - A page to access the messaging settings (this is added via the Interface tab in the Configurator. Touch Screen Options, Tab Config: Messaging.)
 - A page to view the recent call log (this is added via the Interface tab in the Configurator. Touch Screen Options, Tab Config: Messaging.)
2. Click the House icon to access the House voicemail box.

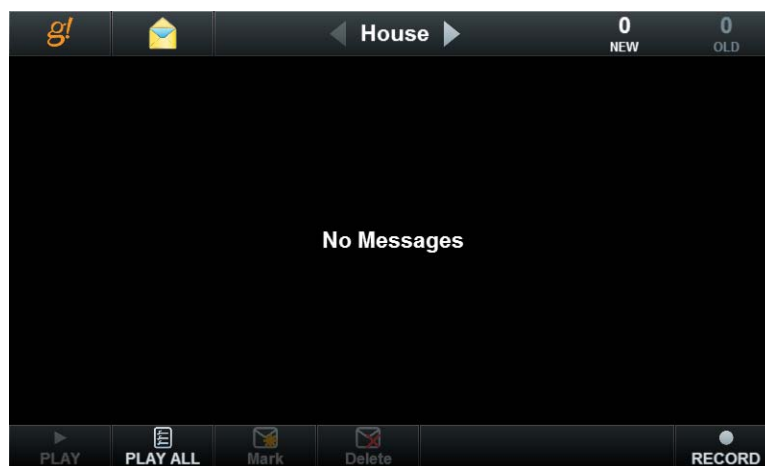

Notice on this page:

- There are no messages in the g!Demo; an actual system would show messages here.
 - Options to playback and delete messages
 - Options to adjust playback volume.
3. Click the Messaging icon next to the **g!** at the top to access the other messaging screens, then click **Settings**.

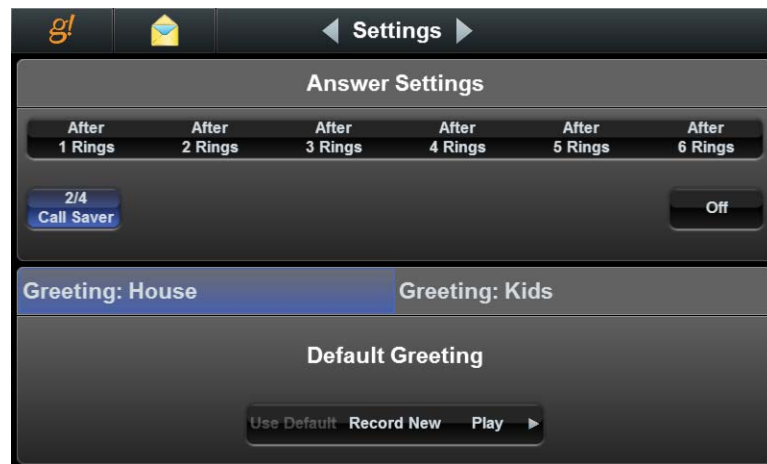

Note: On this screen there are options to configure the greeting and answering system pickup time. A Greeting will need to be recorded for each voice mailbox.

4. Click the Messaging icon next to the **g!** at the top, then click **Call Log**.
*The **Call Log** displays a list of recent calls.*

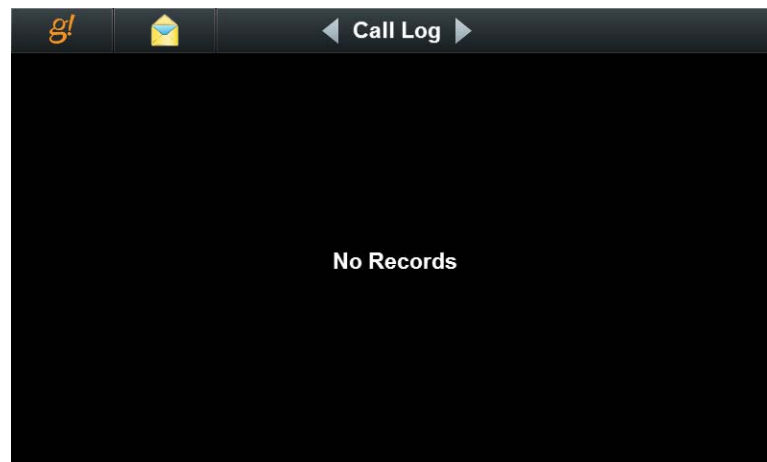

- Click the Messaging icon next to the **g!** at the top, then click **Home**. **Home** displays the emails received for this account in the **g!Viewer**.

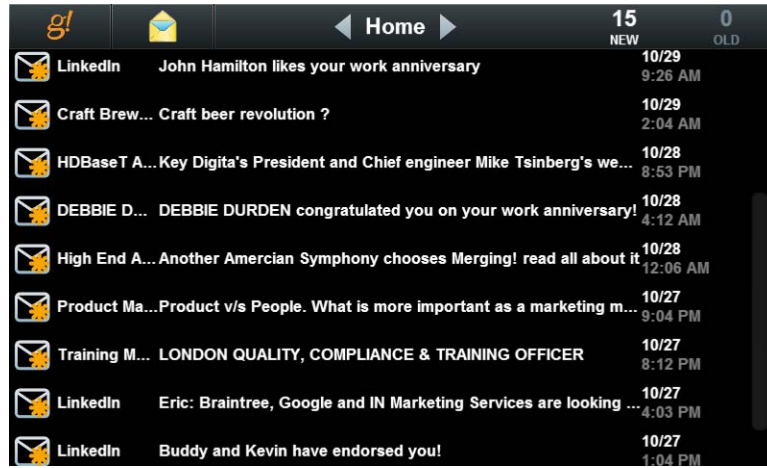

Lesson 13

Configuring Irrigation Systems



Overview

This lesson shows you how to configure an irrigation system.

You will:

- Learn how irrigation systems are organized in the Configurator.
- Use the Configurator to set up communication for the irrigation controller and add the controller
- Configure irrigation groups.
- Add irrigation zones and assign them to irrigation groups.
- Learn how to configure watering schedules
- Check the Viewer to confirm proper configuration.
- Understand the various features available in the Viewer.

Sample House

Our sample house will be configured as follows:

- Two irrigation groups: Lawns and Flower Beds.
- Four zones: One rotor zone and one spray zone for the lawns and two drip zone valves

Requirements

- g! system controller and g!Tools.

Irrigation Integration Overview

Overview The following diagram shows the sample house irrigation system schematically, illustrating the components that are important to the g! system controller.

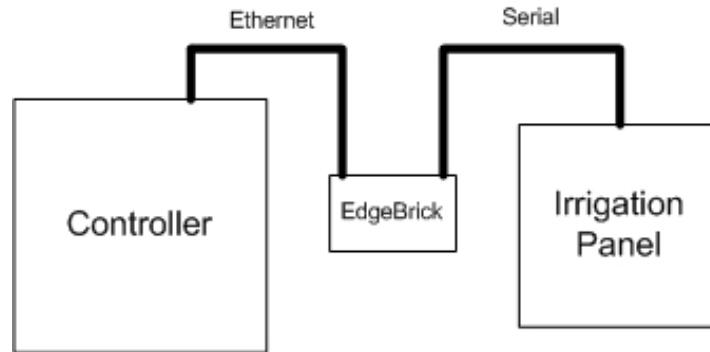

Integrating the irrigation panel with the g! software will provide the homeowner access to their irrigation system through the Viewer. For the irrigation system in their home, they will be able to:

- View system status
- Manually activate individual zones
- Manage watering schedules and seasonal adjustments
- Review watering history.

Terms The following terms are used in the Configurator:

- **Communication Device:** The method the g! software uses to communicate with an external device, including information about the connection type and protocol.
- **Irrigation Controller:** The actual irrigation controller (manufacturer/model) that is integrated.
- **Irrigation Group:** A group of similar plant-type irrigation zones. Typical irrigation groups include **Lawns** and **Flower Beds**. Irrigation zones are grouped to provide appropriate watering schedules for the zone types. For example, the flower beds may need to be watered on a daily basis but the lawns only watered every few days. Each Irrigation Group will display in the Viewer as a separate tab to allow individual group scheduling.

- **Irrigation Zone:** An individual water valve in the system, such as **Lawn Rotors** or **Flower Drips**. These are the valves that the controller will activate to start watering. Note that there is often more than one spraying head per zone but only one zone can be active at a time.
- **Global Irrigation Periods:** A time of the day for which you will schedule a watering.

How-to

To integrate an irrigation system

- Add the **Communication Device**
- Add the **Irrigation Controller**
- Add the **Irrigation Groups**
- Add the **Zones** and assign them to an **Irrigation Group**
- Check the **Viewer** interface

Note: Refer to the irrigation controller integration notes for details.

Exercise 1: Add the Communication Device

Overview In Exercise 1, you will add a **Communication Device**. The Communication Device is the bridge between the g! software and the irrigation controller, and is where you will specify how the systems are physically connected and what communication protocol should be used.

Note: Actual system setup may be different depending upon which irrigation controller is installed on site. Refer to the *Integration Notes* for the particular controller for details.

- How-to*
1. In the Configurator, click on the **Irrigation** tab. Right-click **Communication Devices** and click **Add New Communication Device**. *The Add New Communication Device window opens.*
 - a. Enter "**Irrigation**" as the **Device Name**.
 - b. Set **Communication Type** to **Standard Connection**.
 - c. Set the **Hardware Type** to **(IP to Serial) SerialBrick**.
 - d. Select the **Irrigation Brick** in the **Edge Brick** drop-down menu.
 - e. Click **OK**.

Note: When using the Virtual Irrigation controller the communication device is not needed.

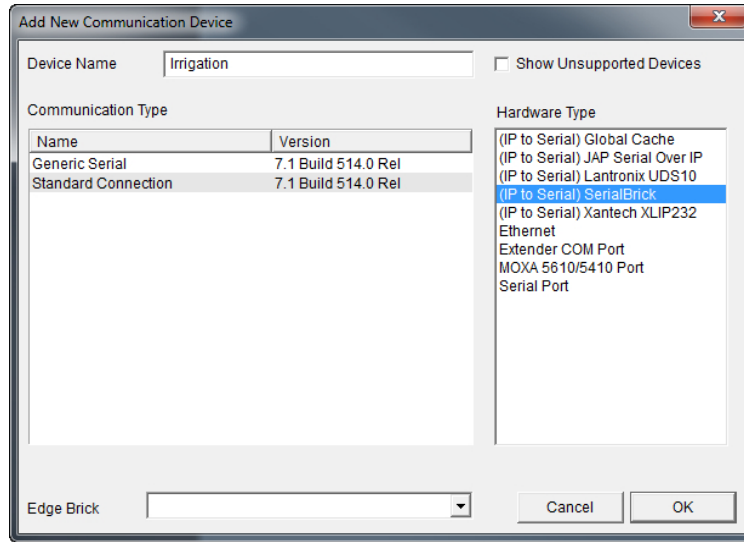

Quick Reference: Add New Communication Device	
Device Name	Enter a name for the external device. This can be any name, but should be descriptive so that you can identify this specific device in the Configurator. DO NOT leave this field set to "New Device".
Type	The type of connection you are using, such as serial port or Ethernet.
Device	This field will populate only if needed, depending on the selected Type.
Communication Type	This is the protocol of the communication. See the <i>Integration Note</i> for the specific irrigation controller for more information.
Show Unsupported Devices	Select this checkbox to display legacy devices on the Device dropdown list. Legacy devices have not been tested with the current version of g! and are no longer supported by ELAN. If you choose to install an unsupported device, a message will display to warn that the device is not supported by ELAN technical support.

Exercise 2: Add the Irrigation Controller

Overview At this point the Communication Device is configured, so now you will add the irrigation controller.

Note: Actual system setup may be different depending upon which irrigation controller is installed on site. Refer to the *Integration Notes* for the particular controller for details.

How-to

1. In the Configurator, right-click **Irrigation Controllers**, then click **Add New Device**.
2. In the **Add New Device** dialog box, select **Virtual Irrigation Controller**, and then click **OK**. *This adds a new irrigation controller.*

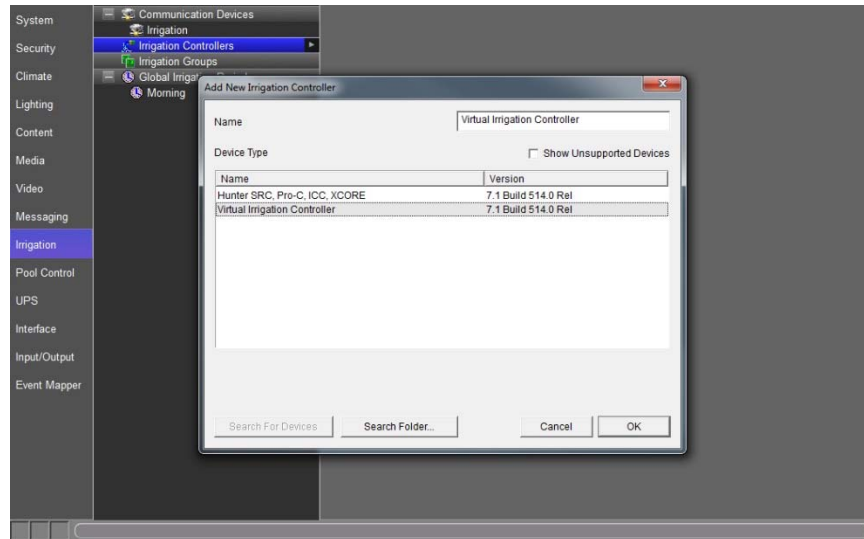

3. Select the new irrigation controller in the Configurator tree. *The properties for that controller display on the right.*

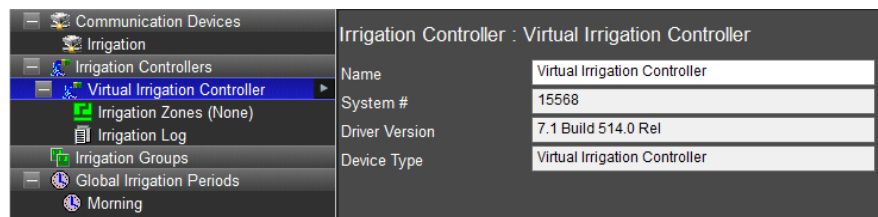

Exercise 3: Add Irrigation Groups and Irrigation Zones

Overview At this point the irrigation controller has been added and set to communicate with the g! system controller. You will now add Irrigation Groups and Irrigation Zones, and then associate the zones with Irrigation Groups. Each Irrigation Group will populate in the Viewer as a separate tab in the scheduler view. Assigning zones to the Irrigation Groups will allow you to schedule watering for the zones separately in the Viewer.

How-to

1. Add two Irrigation Groups.
 - a. Right-click on Irrigation Group and click **Add New Irrigation Group**.
The add Irrigation Group box opens.
 - b. Enter the name of the group as **Lawns** and click **OK**.

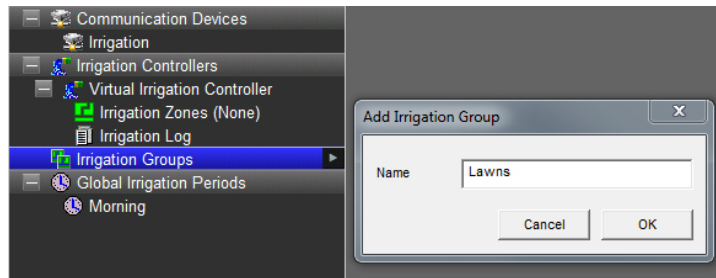

- c. Repeat the two steps above to add another irrigation group named **Flower Beds**.
 - d. Your configuration should now look similar to the screen below.

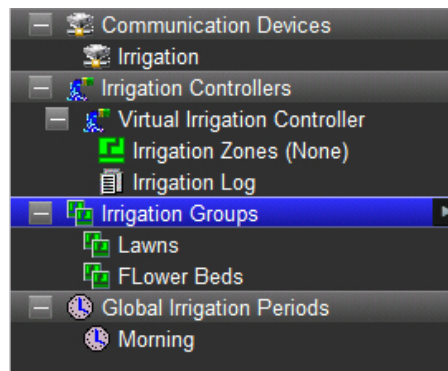

2. Add four irrigation zones and assign them to zone groups.
 - a. Right-click **Irrigation Zones** in the System Tree and select **Add New Irrigation Zone**. *The Add Irrigation Zone box opens.*
 - b. Set the **Zone Name** of the first zone to **Lawn Rotors**. *This is the zone name as it will be displayed in the Viewer.*
 - c. Set the **Irrigation Group** to **Lawns**. *This step assigns the zone to an Irrigation Group*

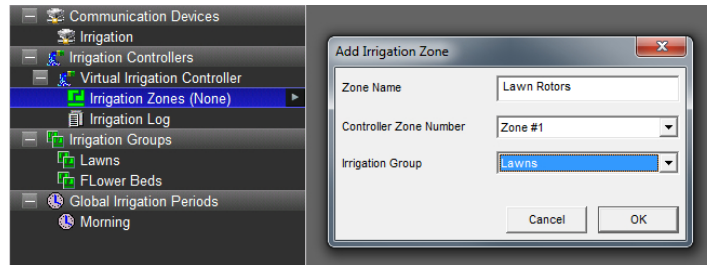

- d. Click **OK** to add the new zone

Note: The Controller Zone Number is the zone output on the actual irrigation controller. By default this will start at Zone #1 and increase incrementally.

3. If you are adding zones out of order, select the proper Controller Zone Number following these steps:
 - a. Repeat step 2a-d to add a second zone named **Lawn Sprays** and assign to the **Lawn** irrigation group.
 - b. Add a third zone named **Front Flower Drips** and assign it to the **Flower Beds** Irrigation Group

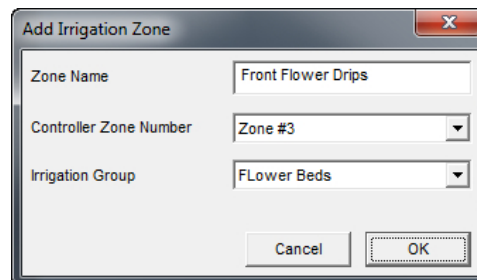

- c. Add a fourth zone named **Side Flower Drips** and assign it to the **Flower Bed** Irrigation Group.

4. Your configuration should look similar to the example below.

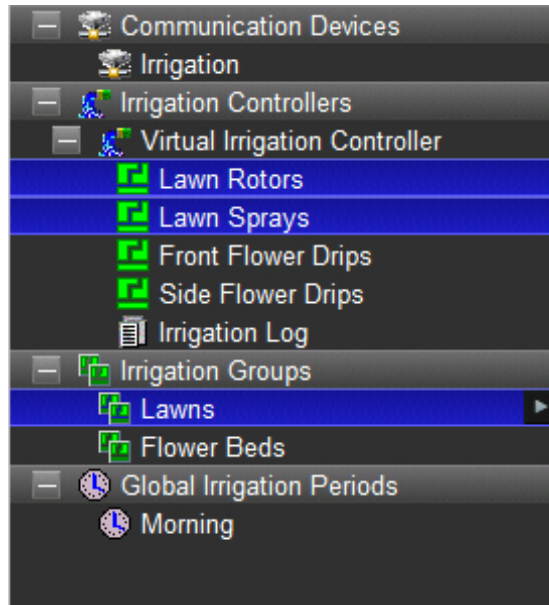

Note: Clicking on Irrigation Groups in the tree will highlight all zones assigned to that group.

Exercise 4: Add Global Irrigation Periods

Overview At this point the irrigation system has been configured and you now need to set up the irrigation scheduling framework in the Configurator. You will add one Global Irrigation Period for each time of day that you will be watering.

By default, the irrigation scheduler includes one Global Irrigation Period named Morning. In this exercise you will add a second period for afternoon. Each Global Irrigation Period will add a place holder in the Viewer for setting the actual time of day to begin the watering.

How-to

1. Right-click **Global Irrigation Periods** in the System Tree and select **Add New Irrigation Period**.

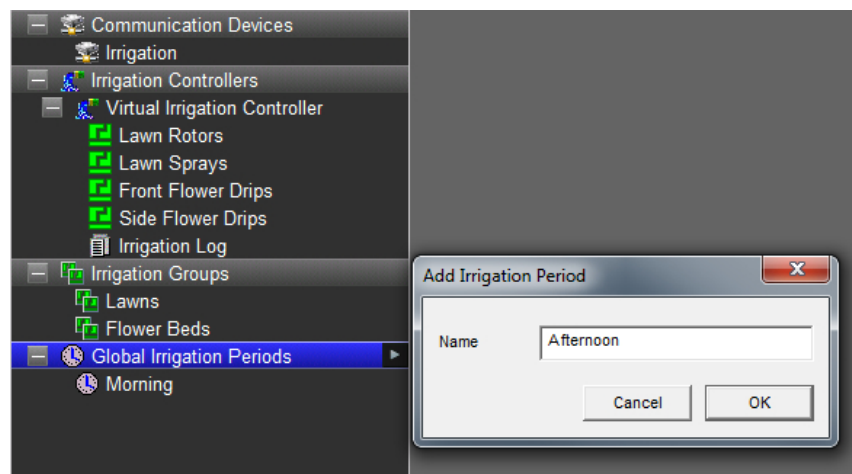

2. Enter **Afternoon** as the name, and then click **OK**. *Your configuration should now look similar to the example below.*

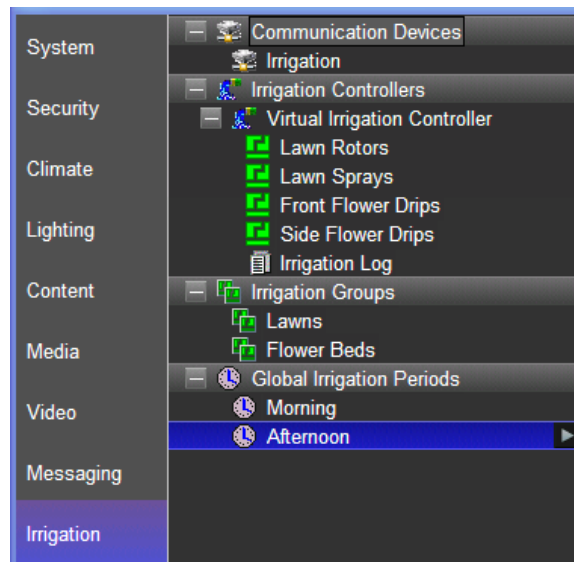

Exercise 5: Check the Viewer

Overview In this exercise you will use the Viewer to check the irrigation system configuration and learn about the features and controls related to the irrigation system. Note that the Irrigation icon does not appear in the Viewer by default. Use the Interface tab, Touch Screen Options, Tab Config: Irrigation System in the Configurator to set up the display.

How-to

1. Open the Viewer to access the g! Home page. Click the **g!** icon to access the main system icons then click the irrigation icon navigate to the **Irrigation** screen.



In the example above you can see:

- a. There are icons at the top of the screen to view system status, schedule, and history.
- b. The current system status is **All Zones Off**. This means that there are no zones currently watering. When the system is running a scheduled watering, the current active zone will display in the status window.
- c. The system is currently in **Run Program** mode. This means that it will run any scheduled watering events.

2. Configure the schedule for the Lawn Irrigation Group as follows.
 - a. On the Status tab, change the status from Run Program to **Off**.
 - b. Set the schedule for the Lawn Rotors to run for 10 minutes and the Lawn sprays to run 8 minutes every Monday, Wednesday, and Friday starting 20 minutes after sunrise.
 - c. Confirm that the Lawn zones will not water during the afternoon schedule.

To do this:

- a. Click the **Schedule** icon at the top of the page.
- b. Click on the **Lawn Rotors** zone then click the **More Time** button until the **Base Time** is set to 10 minutes.
- c. Click on **Lawn Sprays** and adjust the Base Time to 8 minutes.
- d. Click the **Days of the Week** button to highlight it then click **Mon**, **Wed**, and **Fri** to highlight them and set them as the days to water.
- e. Verify that watering times for the Lawn zones are set to zero minutes for the **Afternoon** schedule. *This will keep the lawn from watering at the afternoon period.*



- Click the **Start Times** tab to set the times for both the Morning and Afternoon periods. Click **Sunrise** for Morning then use the arrow buttons to increment to + 20 minutes. Set **Clock** for afternoon, then use the arrows to set the desired start time.

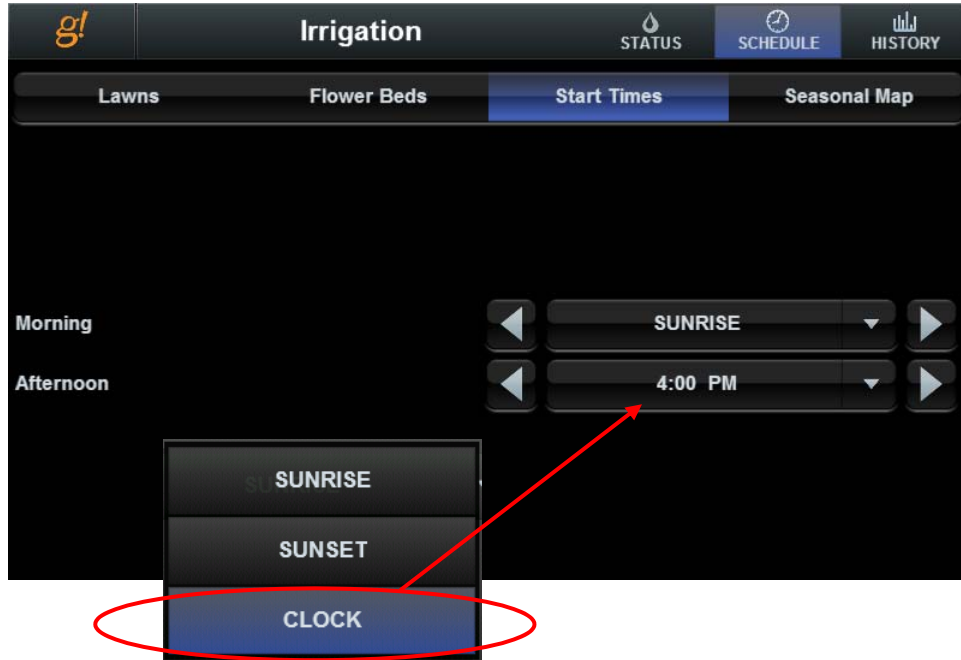

Note: Any time a schedule adjustment is made, the System Mode will change to **Off**. Once you have finished making schedule changes, click **Run Program** to start the system running the new schedule.

- Repeat the steps above to configure the schedule for the Flower Beds Irrigation Group so that each Flower Bed Drip zone waters for 10 minutes in the morning and again at 4pm in the afternoon every day of the week. Your Flower Bed schedules should look like the examples below.

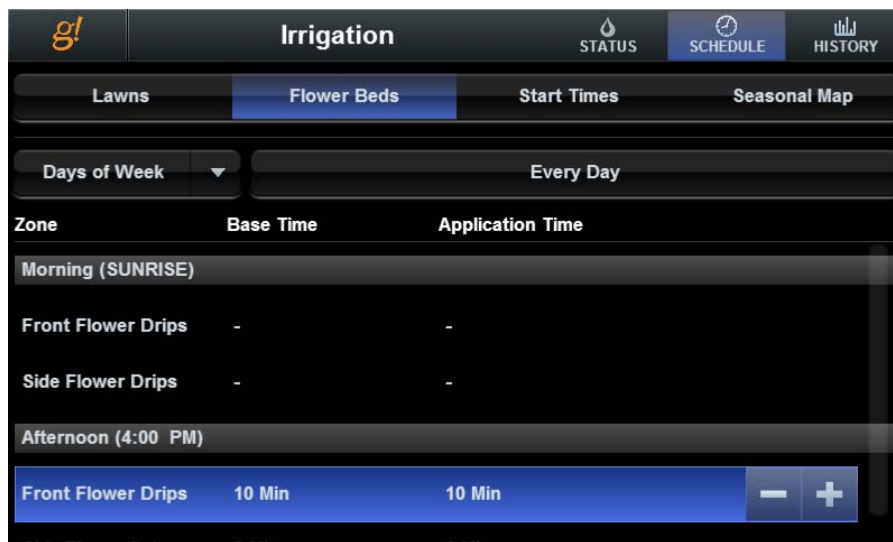

With this schedule set up, the system will water the Lawn zones followed by the Flower Bed zones in the morning starting at 20 minutes after sunrise. Since irrigation controllers will only water one zone at a time, the system will begin watering with the first zone in the list, in this case the Lawn Rotors.

Once that zone has run for its scheduled time, it will shut off and the Lawn Sprays will start. Next, the Front Flower Drips will run, followed by the Side Flower Drips. Then, at 4pm only the Flower Bed zones will water in order from top to bottom.

5. Click on the **Seasonal Map** tab. This tab allows you to adjust the percentage of application time on a month by month basis. This is useful as an adjustment during spring and fall when the temperatures are not as high and watering requirements are less. A typical system may be adjusted as shown in the screen below.

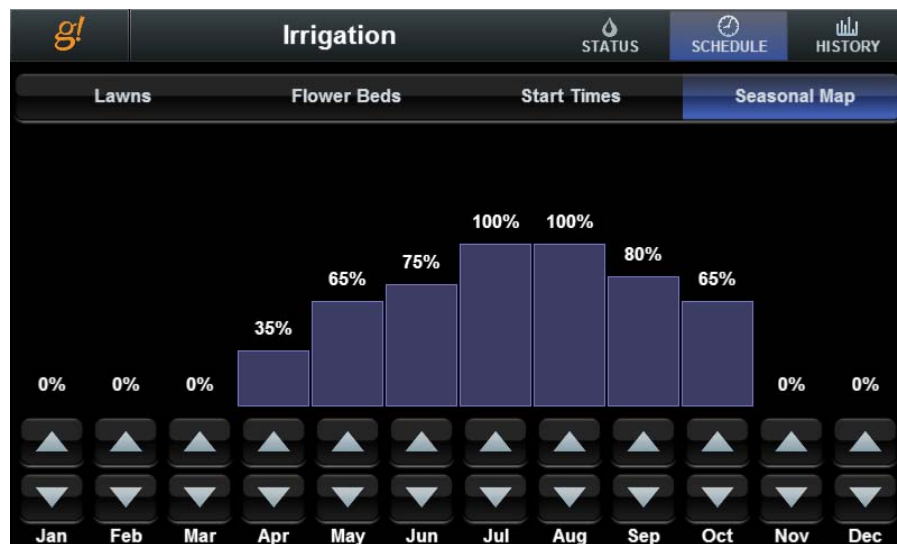

To adjust the percentage for each month, click and hold the arrow (up arrow to increase percentage, down arrow to decrease percentage) until the desired percentage is displayed. The longer the arrow is pressed, the faster the percentages will scroll.

Lesson 14

Configuring Pool Systems



Overview

This lesson will show you how to configure a pool controller in the g! software.

You will:

- Learn how to add a pool controller.
- Learn how to control and schedule pool functions in the Viewer.

Requirements

- g! system controller and g!Tools.

Overview

Overview Integrating a Pool System with the g! software provides the home owner with access to control pool features in the present, schedule pool functions for the future, and check the history of pool pumps and circuits. Pool Integration can control, schedule, and report history for many pool devices, including: Filter Pumps, Water Features, Heaters, Chlorinators, Pool Lights, Spa Jets and more.

Note: Specific features available in the g! software will vary depending on the Pool System installed. Please review the Integration Notes for the specific system for more information.

Typically, the pool controller is installed by a pool system professional, and is a fully functional independent system prior to integration with the g! software. In most instances, the Pool & Spa are controlled by a single control board, and an interface adapter is used to connect the ELAN controller electrically with this controller.

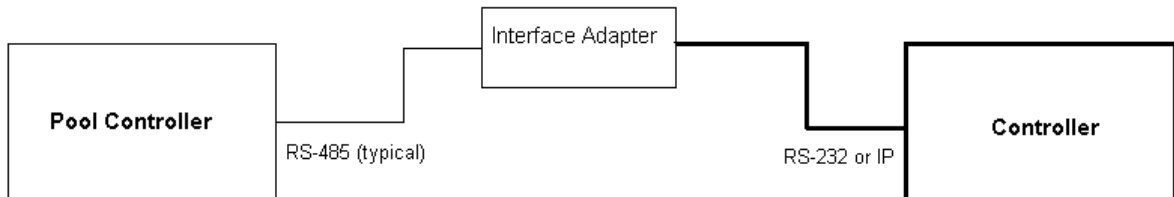

Terms The following terms are used in the **Configurator** to describe the equipment in a pool system:

- **Communication Device:** The method the g! software uses to communicate with an external device and includes information about the connection type and protocol.
- **Pool Controller:** The Pool Controller interfaces with and controls pool devices like filter pumps, heaters, and pool circuits such as fountains or lights.

How-to To integrate Pool & Spa:

- Add the Communication Device
- Add the Pool Controller
- Configure Circuits
- Check the Viewer

Exercise 1: Add the Pool Controller

Overview The Virtual Pool Controller which you will add in Exercise 1 simulates the control, feedback, and temperatures of a real pool system. It closely resembles a fully featured Pool Controller such as a Pentair IntelliTouch.

Note: Actual system setup may be different depending upon which pool controller is installed on site. Refer to the *Integration Notes* for the particular pool controller for details.

How-to

1. In the Configurator, click on the **Pool Control** tab. Right-click **Communication Devices** and click **Add New Communication Device**. *The Add New Communication Device window opens.*
 - a. Enter "**Pool & Spa**" as the **Device Name**.
 - b. Set **Communication Type** to **Standard Connection**.
 - c. Set the **Hardware Type** to **Serial Port**.
 - d. Assign the **COM Port** from the drop-down menu.
 - e. Click **OK**.

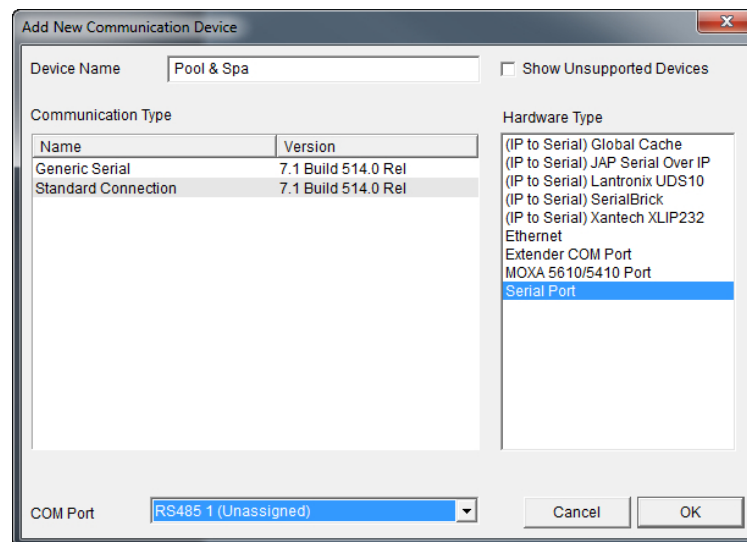

Note: When configuring a virtual Pool System note that a communication device is not necessary. Please review the *Integration Notes* for the specific system for proper serial port settings and additional installation information.

2. Add a Pool Controller.
 - a. Right-click **Pool Controllers**, and select **Add New Pool Controller**. *The Add New Pool Controller window opens.*

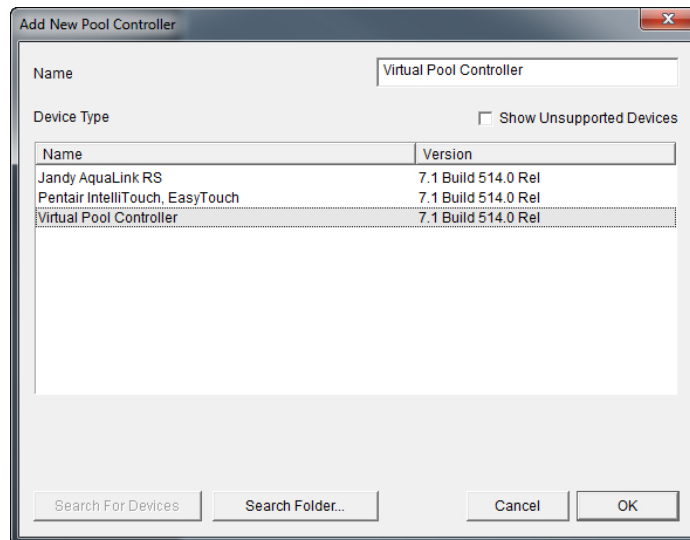

- b. Select **Virtual Pool Controller**, and click **OK**.

Note: In a live system, the next step would typically involve configuring circuits to ensure controls are named correctly and appear in the correct area of the Viewer. However, the Virtual Pool Controller used for this training is hard-coded, and the circuits are not editable.

Exercise 2: Check the Viewer

Overview After adding the pool controller, we will open the Viewer to verify the pool temperature, control pool features, set up a schedule and explore the available options.

How-to

1. Open the **Viewer** and navigate to the default **Pool** screen.
2. The screen typically contains the controls for the filter pump, cleaners, spa jets, and heat settings.



The Main screen is divided into two sections:

- **Pool:** 2-Way toggle buttons for the Pool Filter Pump, Cleaner, and Heating Options. Up and Down arrows alter the heater set point.
- **Spa:** 2-Way toggle buttons for the Spa Filter Pump, Spa Jets, and Heating Options. Up and Down arrows alter the heater set point.
- Click the icon in the upper right corner of the page to access settings for light and water features, schedules, timers, alerts and history.



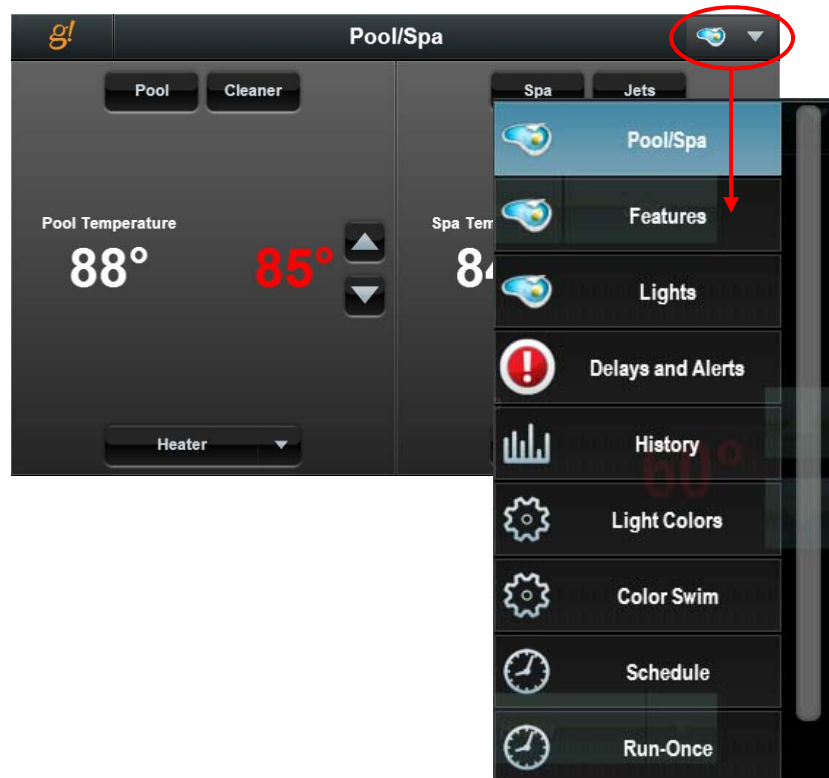

3. Click on the **Features** tab to access the **Water Features** controls. Use this page to control other pool circuits with 2-way toggle buttons.
 - Typically used for major water features such as fountains and waterfalls.
 - Click the **Fountain** button to turn the fountain on.

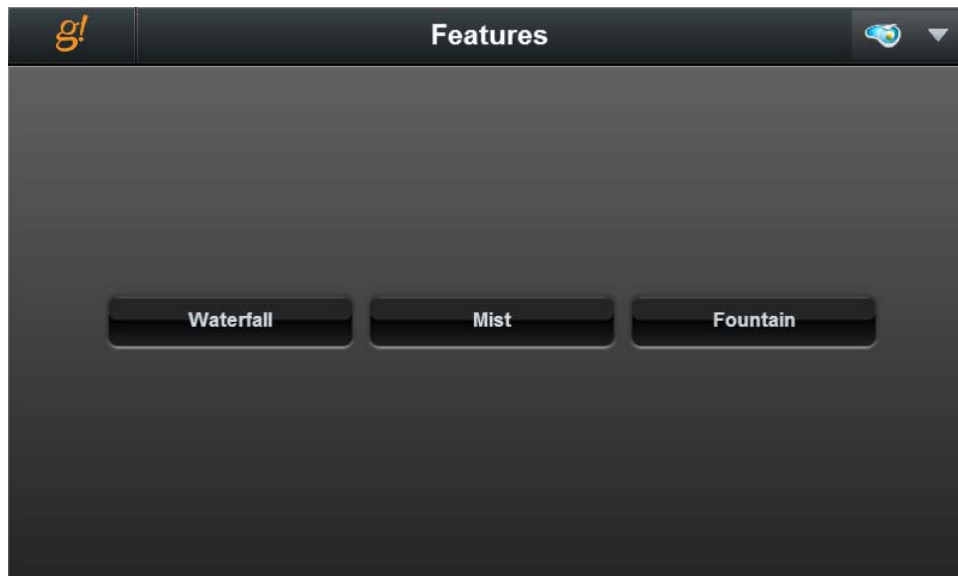

- 4. Click the **Lights** tab to access the lighting control screen. This screen gives you basic on/off and level control (if applicable) of lights controlled by the Pool Controller.

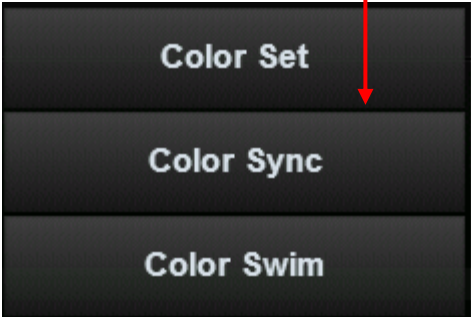
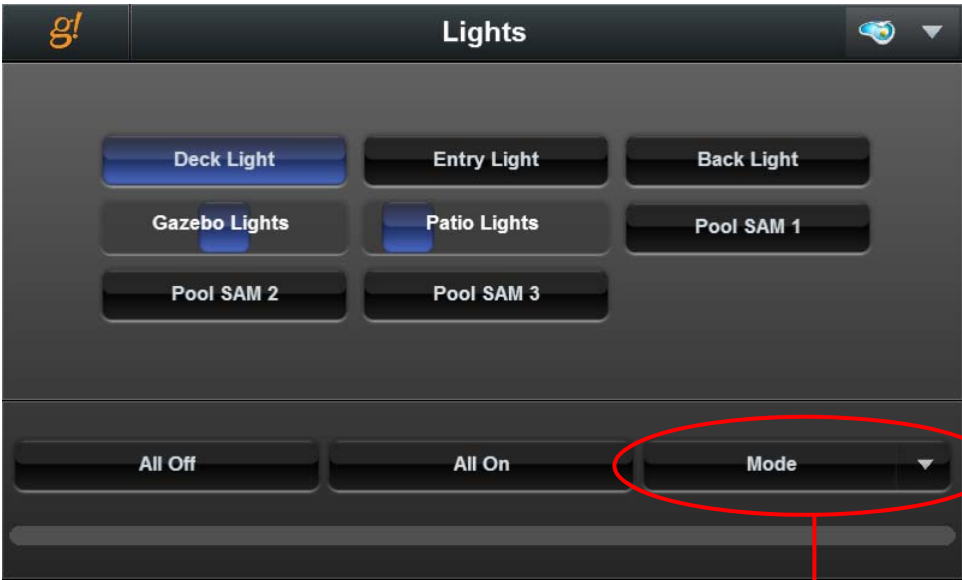

5. Click the **Light Colors** tab. This tab provides access to various settings in the pool system.
 - a. The lighting tabs allow you to adjust the lighting colors on pool systems that have this feature.

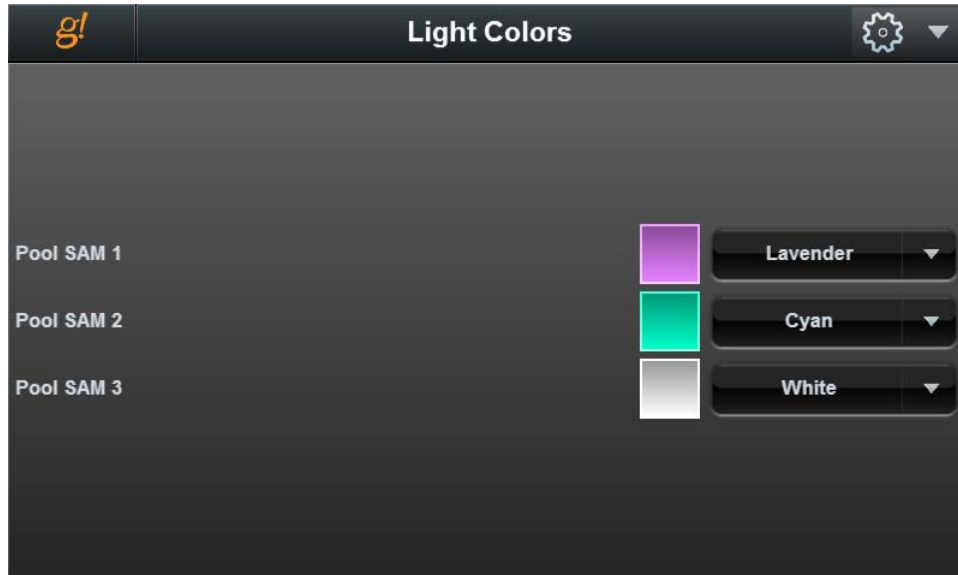

- b. The **Schedule** tab allows you to add scheduled “programs” for pool pumps, water feature circuits, and lighting. These programs will activate the desired filter or circuit for the time period entered, and may be customized to run only certain days and times.



- c. The **Run-Once** tab allows similar features as the Schedule tab, but items set on this page will only run once, rather than repeat the cycle every week. This is useful in instances when there may be some special event, like a party, and you would like to schedule the filter to run on what is usually an off day to ensure the pool is clean for your guests.
- d. **The Circuit Timers tab sets the default interval for pool feature** activations. Typically, when items are activated manually or scheduled on the **Run-Once** tab, they will use the circuit timers to control how long the circuit will stay active. This prevents features like Waterfalls or Lights from running all day and wasting energy, and relieves the home owner of the need to remember to shut them off.



g! Circuit Timers		
Spa	12h 00m	- +
Jets	12h 00m	
Waterfall	12h 00m	
Mist	12h 00m	
Fountain	12h 00m	
Deck Light	12h 00m	
Entry Light	12h 00m	
Back Light	12h 00m	
Cazaba Lights	12h 00m	

6. The **History** tab displays the temperature readings for the Pool, Spa, and outside temperature in a line graph, with colored blocks along the bottom indicating when certain circuits are active. This enables the home owner to track the usage and run times of circuits like filters and heaters alongside temperature readings, and may also be useful as a diagnostic tool.

Lesson 15

Interfaces: GUI, gKP7, TS2, gTP7, TS7/10, OSD, and HR2/gHR200



Overview

This lesson discusses the main options available in the Configurator to customize colors and tab arrangements for in-wall touch screens, wireless tablets and other user interfaces in the system.

You will:

- Learn how to identify Interfaces in a system.
- Change basic settings for each interface and set which Tabs and Zones to show on which interfaces.
- Use built-in Display Settings.
- Use built-in Home Pages.
- Customize Home Pages.
- Add a Web Picture (such as weather radar).
- Configure a gKP7 Keypad
- Configure a TS2 Keypad
- Configure a gTP7 or TS10 Touchscreen
- Configure the On-Screen Display (OSD)
- Configure the HR2/gHR200 Remote

Requirements

- g! system controller and g!Tools.
- User Interface(s)

Overview

Overview This lesson explores many features available to customize the appearance of the Viewer on various interfaces.

In an ELAN system, interfaces include:

- In-Wall Touch Screens
- In-Wall Keypads
- Wireless Tablets
- Computers in the home (on the local network)
- Computers connecting remotely (over the Internet)
- iOS Devices
- Android Devices
- The OSD (On-Screen Display)
- HR2/gHR200 Remote

Terms **The following terms are used in the Configurator Interface tab when setting up the interfaces for a system:**

Interface Devices: Interface Devices are configured per-subsystem and include options for each interface that is connected to the g! system controller locally. Interface Devices include TouchScreen, OSD, TS2, HHR (Hand Held Remote), KP7, and Remote Users. Options for Interface Devices include settings such as: what systems are visible on the interface; which tabs, keypads and zones are visible, and power settings.

Home Page: Home Pages are the first page the user sees when logging into an interface. The Home Page is similar to a Custom Tab, and provides the ability to add a variety of controls such as system mode buttons and display information such as the time, a calendar, and weather.

Display Settings: Display Settings are the options for the colors, textures, and sizes of items in a touchscreen layout. These are also referred to as “themes” or “skins”. The g! default display setting is BLACK with an optional BLACK HIVIS (High Visibility) for dimmer screens.

Exercise 1: Identify and Name Individual Interfaces

Overview Each touch screen, computer, or other interface that logs on to a g! system controller will automatically populate an Interface Device (*device type*) entry on the Interface tab. Each Interface Device options entry contains settings for that specific Interface such as power settings and display options.

The first step to managing the settings for a touch screen interface is to know that you are working with the *correct* touchscreen. In this lesson you will learn how to **identify** a touch screen and then **name** it so that it can be edited quickly and easily later on.

Interface Device entries are added automatically for interfaces when those devices (touchscreens, tablets, etc.) connect to the system for the first time. In other words, you don't have to add interfaces manually in the Configurator. Instead, connect the device to the system and power it up. Once it has connected to the ELAN Controller, a new heading will automatically appear in the Interface Devices list in the System Node Tree.

The g! software provides a default interface with the system. When a new device (touchscreen, tablet, etc.) connects for the first time, the new Interface is created with settings *copied* from the **Default** interface. For this reason, Default cannot be deleted and the name cannot be changed.

How-to In the following steps you will identify and name an interface.

1. Start the **Configurator**, and the **Viewer**. Arrange the windows on your monitor so you can see at least a part of the Viewer behind Configurator.
2. In the Configurator, go to the **Interface** tab. In the System Node Tree, under **Interface Devices (TouchScreen)**, select the **Default** interface.

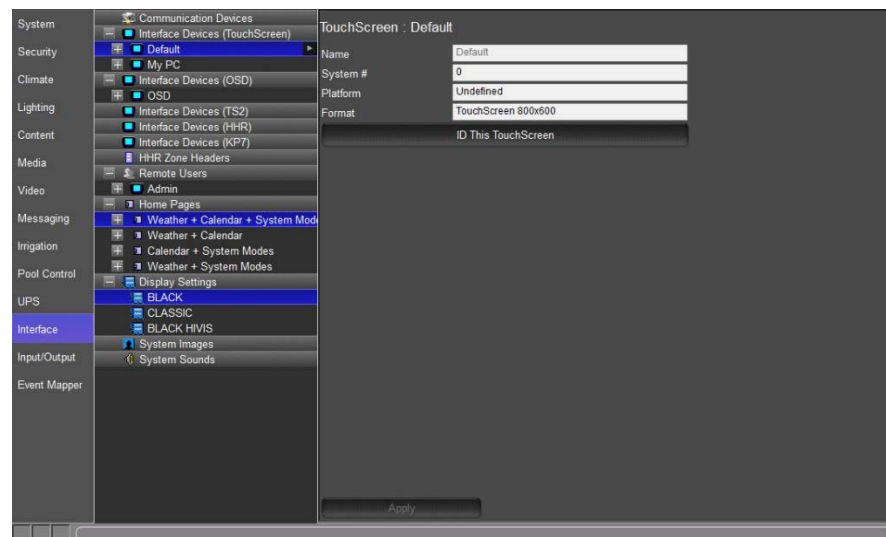

- Note the large **ID This TouchScreen** button in the properties window. Click this button to force the associated client Viewer to black out and display the text in the Name field as shown in the screen below.

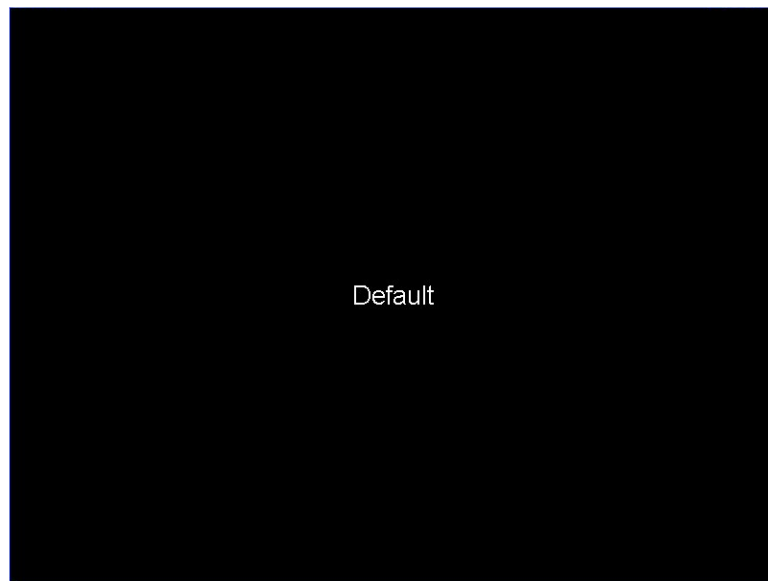

- Click the **ID This TouchScreen** button for each entry under Touch Screen Options until your open Viewer blacks out and displays the name. Once you have found the entry that is your PC, rename it to **MY PC**.

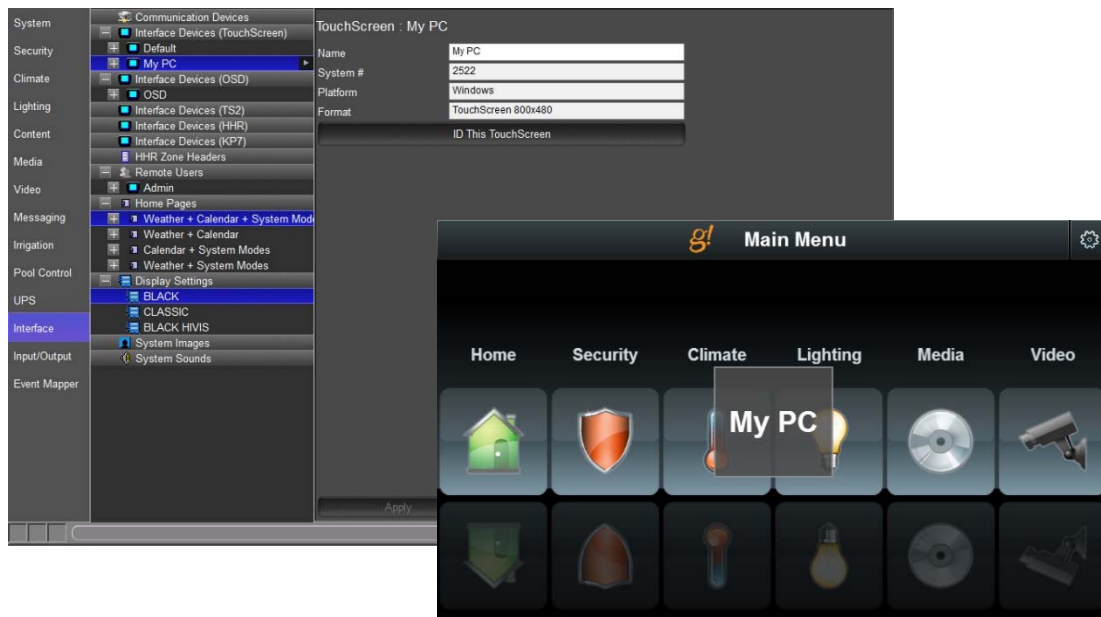

Exercise 2: Explore Interface Settings

Overview Each set of Interface Device options contains multiple headings that allow you to customize everything from what zones and interfaces appear on that particular touchscreen, to changing screen saver, power management, and display settings.

Inside each set of Interface Device options:

- **Power Scheme-** Battery/AC Settings such as display off and screen saver timing.
- **User Interface-** Choose current Home Page, Display Settings, and whether schedules for climate are available on this interface.
- **Advanced Settings-** Toggle Browser tab, enroll in security announcements (if enabled in Security settings) and set volume. Also includes settings related to hardware graphics (typically should be left to defaults).
- **Tab Layouts-** Configure the zones and interfaces (such as keypads) per subsystem for the selected touchscreen.

How-to

1. Navigate to the **Interface** tab and expand the **Default** interface.
2. Click on **Power Scheme**.

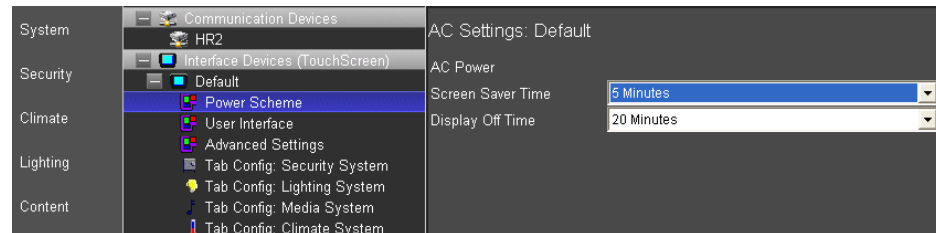

Quick Reference: Power Scheme Fields

Screen Saver Time	Time before the display starts showing pictures.
Display Off Time	Time before the backlight is turned off when on AC Power (tap screen to wake).

3. Click **User Interface**.

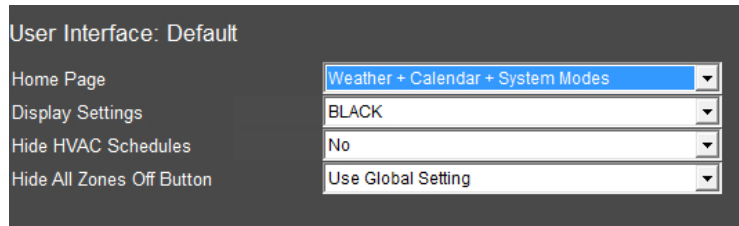

Quick Reference: User Interface fields	
Home Page	Select which home page to show.
Display Settings	Select the color settings to use.
Hide HVAC Schedules	Don't show the climate scheduling page on this interface.
Hide All Zones Off Button	Selects whether display or hide the All Zones Off button on this interface. Factory default is to display the All Zones Off button.

4. Use the **Tab Layouts:Tab Config** to configure which tabs are shown on each interface. For example, click on **Tab Config: Lighting System**. Notice that **Master** and **Theater** are set to be displayed on the **Default** interface, and the Custom Tab is not shown.

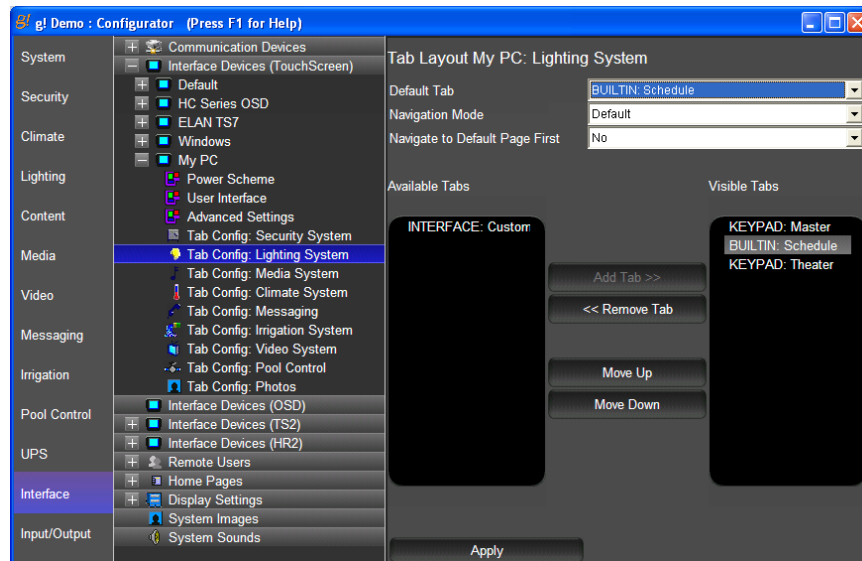

Exercise 3: Home Page Setting

Overview The system comes pre-configured with several built-in Home Page layouts. In the following steps, you will select from among the different built-in Home Pages to see the differences.

- How-to**
1. Navigate to the **Interface** tab, expand the **My PC** interface, and select **User Interface**.
 2. In the properties window at right, select **Weather + Calendar + System Modes** from the **Home Page** drop-down list, and then click **Apply** at the bottom of the screen.

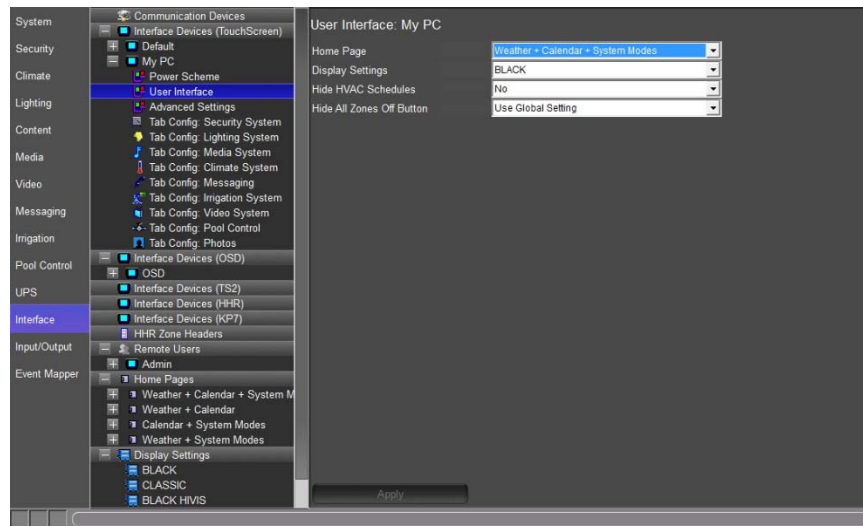

3. Go to the **Viewer**, to observe how the new **Home Page** appears.



4. Change **Home Page** to **Weather + System Modes** and view the change.

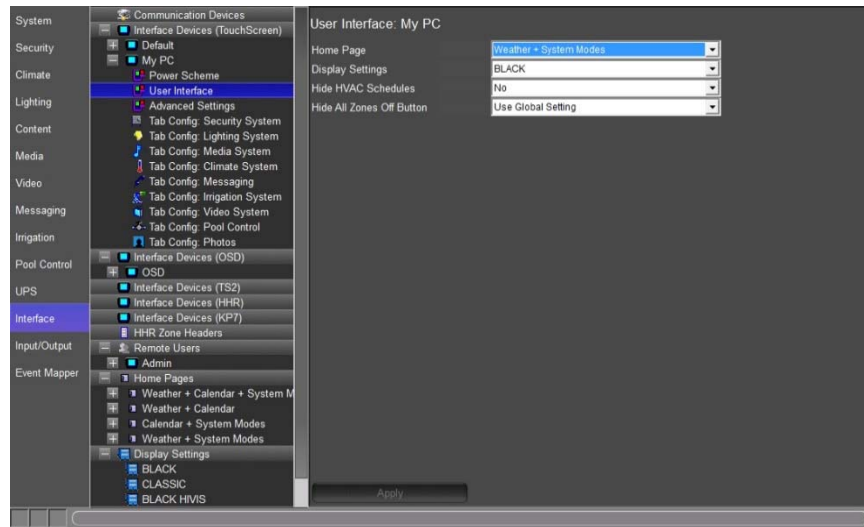

5. Go to the **Viewer**, to observe how the new **Home Page** appears.

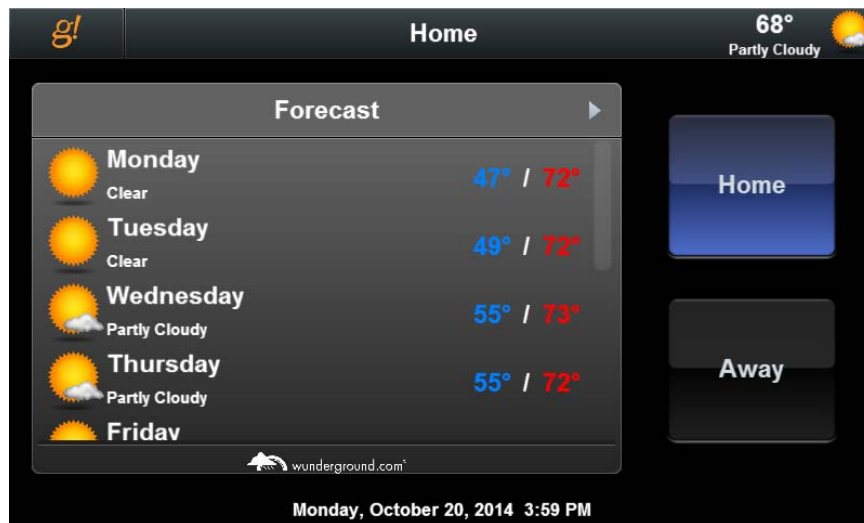

Exercise 4: Creating a Custom Home Page

Overview In Exercise 4, you will create a customized Home Page. As with color settings, the built-in Home Pages are not meant to be modified. Instead, we will create a new Home Page using Default 2 as the starting point and add a web image to it.

- How-to**
1. First, add a static, refreshing jpg image to populate on the Home Page. This image originates from the Internet, and requires a link on the Web to the desired image. *If you don't have Internet access, skip the following steps.*
 - a. Open a web browser and navigate to a weather site such as www.weather.com.
 - b. Browse for local weather, and then find an image map that shows current weather conditions for your area.

For example, go to www.weather.com and type in your zip code. Locate, and select, Map on the left of the screen. Select the desired map in the More Classic Maps area on the right.

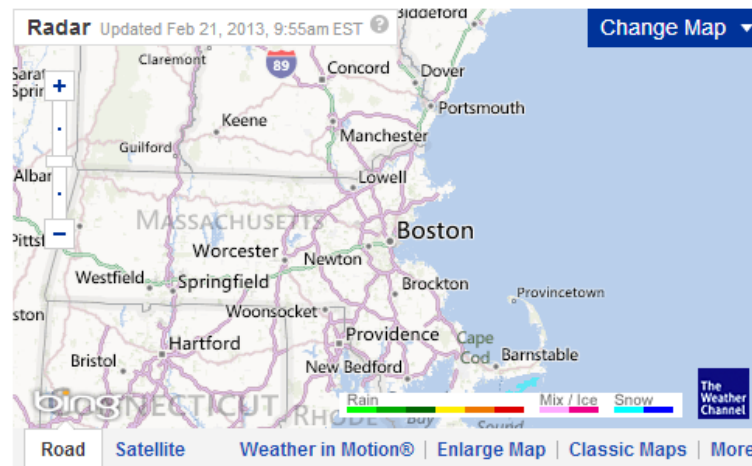

Click on the **Classic Maps** link to get a standard JPG file instead of the interactive map.



Note: You must use a static image file: html pages, Flash, and javacript will not load.

- c. For Windows IE, right-click inside the image, and select **Properties**. In the **Properties** dialog box, use your mouse to highlight the **URL**, and then press **CTRL+C** to copy the text.

In Internet Explorer:

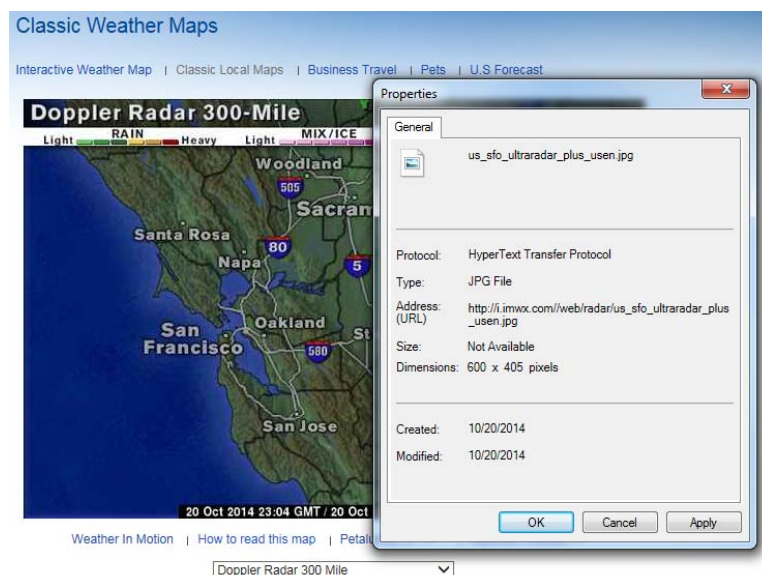

In **Google Chrome**, right-click inside the image and select **Copy Image URL** from the popup menu.

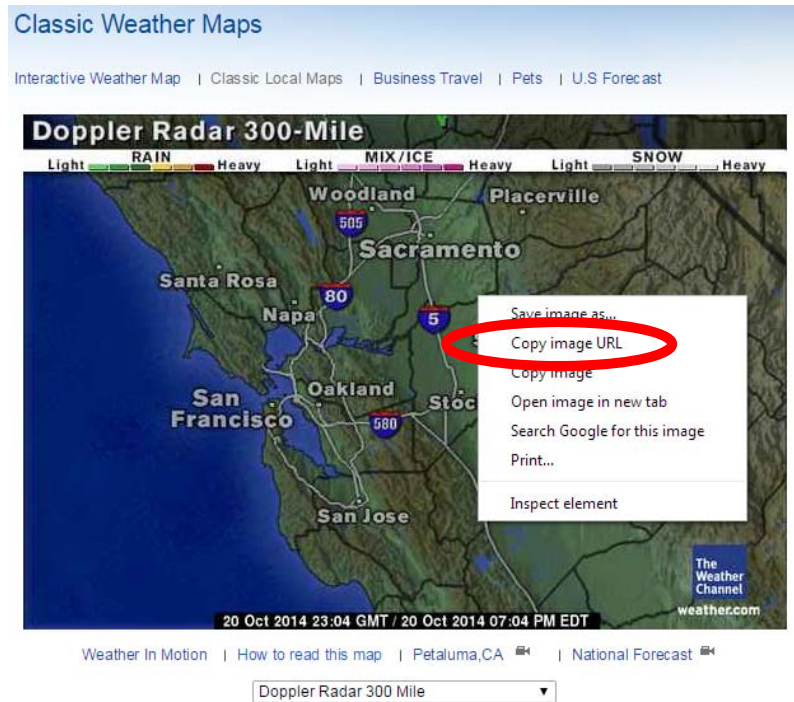

d. In **Configurator** click on to the **Content** tab. Right-click **Web Pictures**, then **Add New Web Picture**.

e. Set the **Name** to “**Local Weather**” and click **OK**.

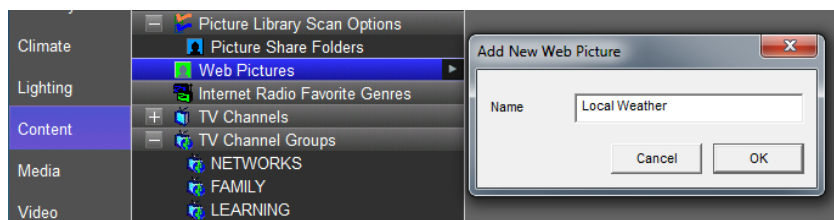

f. In the properties window for the new **Web Picture**, place the cursor in the URL edit box, and then press **CTRL+V** to paste the URL text for the weather image that you copied earlier.

g. Click **Apply** at the bottom of the screen.

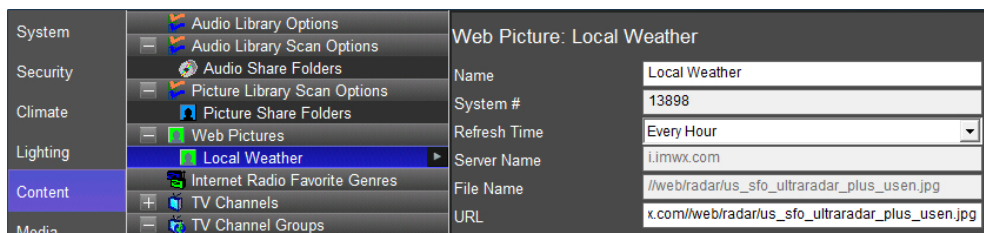

2. Add a new Home Page on the **Interface** tab. Right-click **Home Pages**, and then click **Add New Touch Screen Home Page**.
 - a. Set the **Name** to “My Home Page”,
 - b. Select **Weather + Calendar** from the **Copy From** list.
 - c. Click **OK**. *This creates a new Home Page and starts it off with the same layout as the built-in g! Weather + Calendar.*

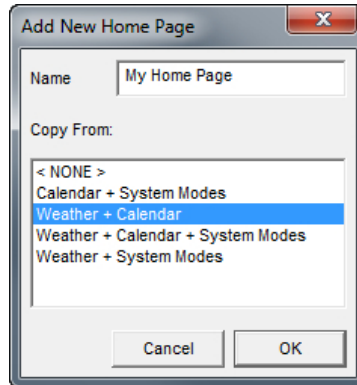

3. Delete the Calendar Control.
 - a. Expand **My Home Page**.
 - b. Select Large Format from the list of Viewer resolutions, then Large Landscape (Wide) from the properties pane on the right.

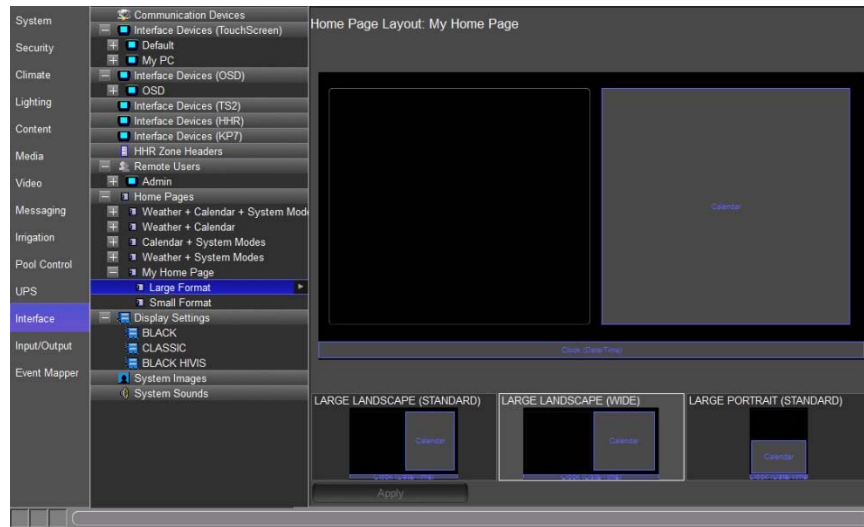

Quick Reference: Screen Resolutions	
Large Format	<p>Large Landscape (Standard). Viewer running on g!Tools Traditional Viewer, ELAN 8.4” in-wall, and 8.4” wireless tablets.</p> <p>Large Landscape (Wide). Viewer running on g!Tools Wide Viewer, gTP7, TS7, TS10 or Valet 10 tablets.</p>

	Large Portrait- Viewer running on an iPad or Android tablet devices.
Small Format	Portrait or Landscape resolutions for iPhone, iPod Touch, or Android smart phones.

- c. Select the smaller block on the right– this is a **Calendar Control**. Right-click the control, then select **Delete Control** to remove the calendar.

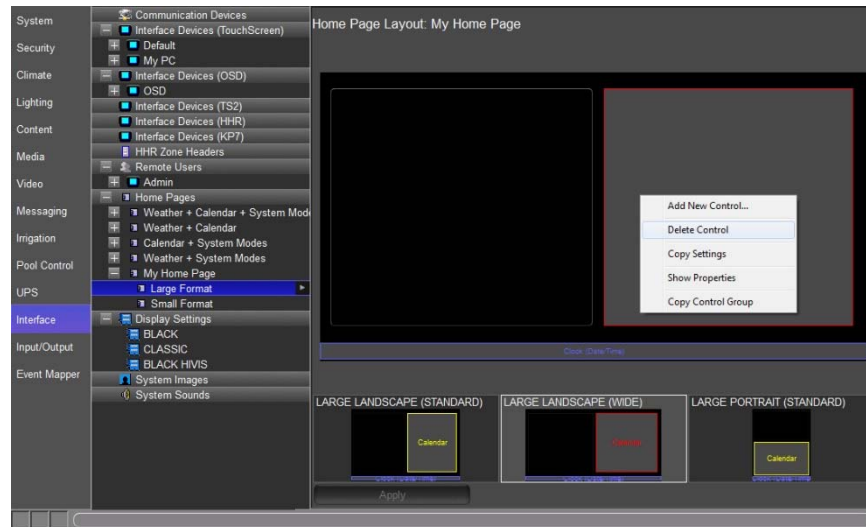

4. Add a new control to display a web image in its place:
- Right-click in the open area, then click **Add New Control**.
 - Select the **Picture From Internet** control, set the name to “Local Weather” and click **OK**.

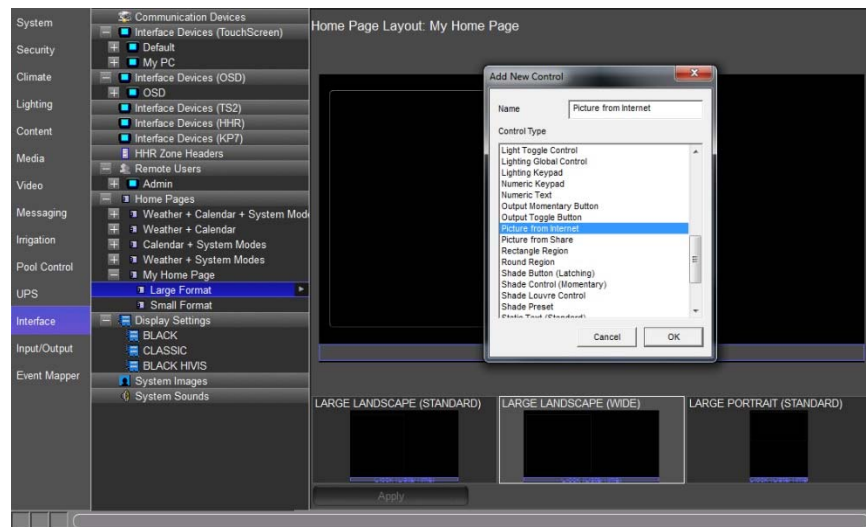

- c. Select the newly added control type and use the drop-down in the **Picture from Internet Properties** window to link it to the Web Picture added previously.

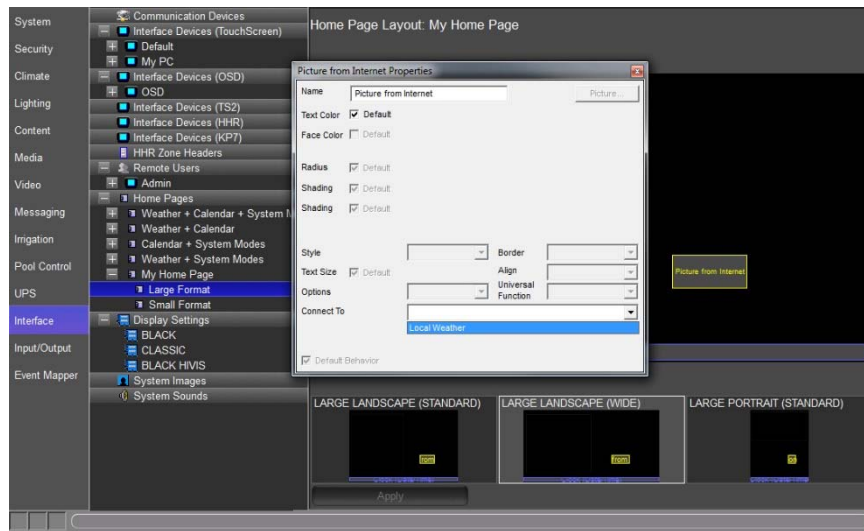

- d. Resize the control to make it roughly the size of the calendar deleted in step 3c. Click **Apply**. Notice the box automatically snaps to the correct aspect ratio for your web image. (This will only happen if you have an internet connection and you pasted a valid picture link).

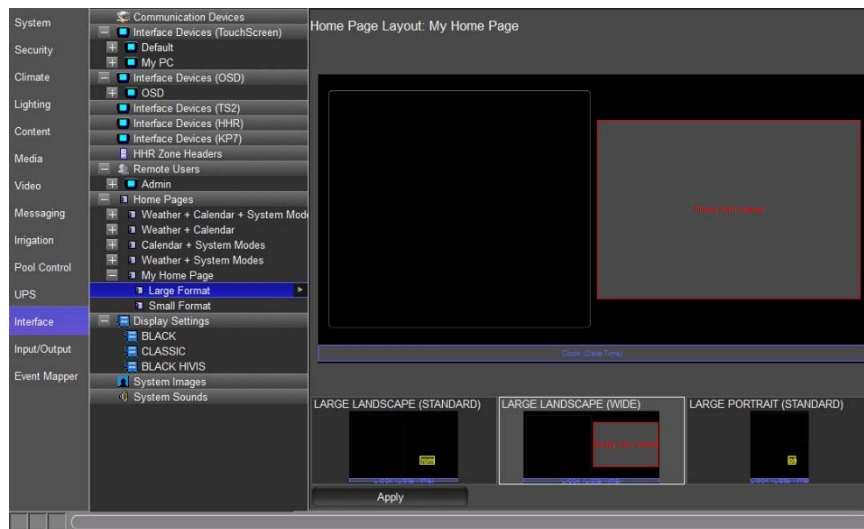

5. Set the interface to use the new Home Page.
 - a. On the **Interface** tab, expand the **My PC** interface, and select **User Interface**.
 - b. In the properties window at right, set the **Home Page** field to **My Home Page**. Click **Apply**. *The My PC interface will now use the custom Home Page instead of the built-in.*

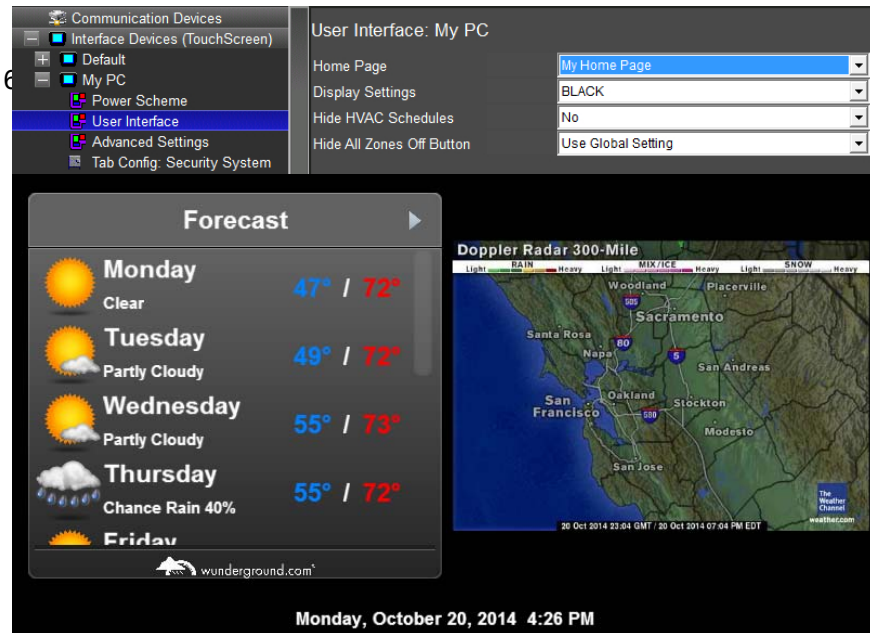

The screenshot shows a configuration window for 'My PC' under the 'Communication Devices' tab. The 'User Interface' is selected, and the 'Home Page' is set to 'My Home Page'. Other settings include 'Display Settings' (BLACK), 'Hide HVAC Schedules' (No), and 'Hide All Zones Off Button' (Use Global Setting). Below the settings is a weather forecast and a Doppler Radar map.

Forecast

Day	Weather	High	Low
Monday	Clear	47°	72°
Tuesday	Partly Cloudy	49°	72°
Wednesday	Partly Cloudy	55°	73°
Thursday	Chance Rain 40%	55°	72°
Friday			

Doppler Radar 300-Mile

Light RAIN Heavy Light MIX/ICE Heavy Light SNOW Heavy

Woodland Placerville
Sacramento
Santa Rosa Napa San Andreas
San Francisco Oakland Stockton Modesto
San Jose

20 Oct 2014 23:04 GMT / 20 Oct 2014 07:04 PM EDT
The Weather Channel
weather.com

wunderground.com

Monday, October 20, 2014 4:26 PM

Exercise 5: Configuring the gKP7

Overview The gKP7 is a 7 button keypad with 5 fully configurable function buttons and two raise/lower buttons with flexible functionality as well. The gKP7 fits in a single gang box and is powered with PoE, Power over Ethernet. The gKP7 is IEEE 802.3at compliant and may be used with PoE injectors or PoE switches.

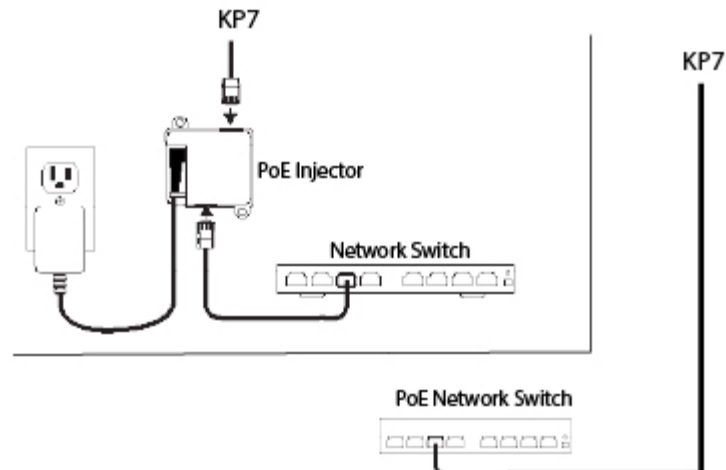

When used as a media interface, the gKP7 controls one zone and allows the end-user to conveniently store and recall stations from any g! supported two-way tuner, playlists from an ELAN g! MP3 player, channels and playlists from compatible streaming content devices (Autonomic, LMS, & Sonos), as well as accessing and initiating playback from legacy devices like CD players and satellite boxes.

Before installing the gKP7 note the MAC ID on the front upper left corner of the keypad. ELAN recommends writing down the MAC ID number and the location name where the gKP7 will be installed.

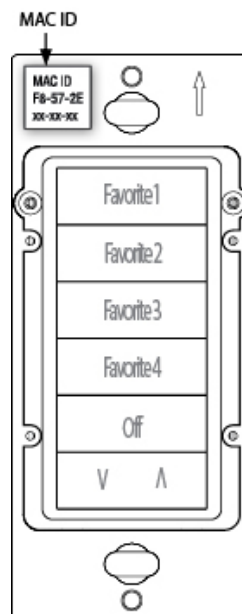

Once the gKP7 is installed ensure the unit is powered on and then access the g! Configurator.

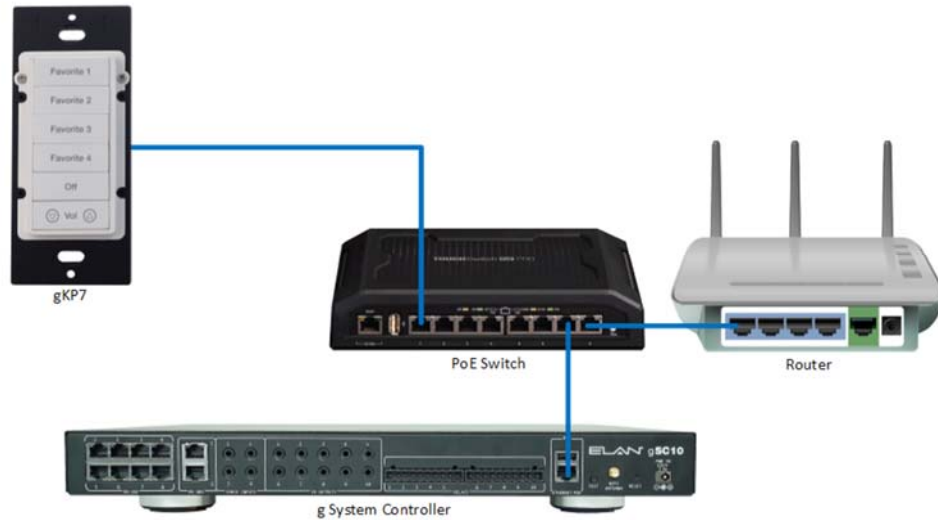

Note: The gKP7 is only powered over PoE. Once the PoE device connected to the gKP7 receives power the gKP7 will power on.

How-to

Add and configure the gKP7

1. Start the **Configurator**, click the **Interface** tab at left, then click **Communication Devices**.
2. Right-click **Communication Device** and select **Add New Communication Device**. In the dialog box:
 - a. Enter “ELAN KP7” as the **Device Name**
 - b. **Communication Type** select **ELAN KP7 Controller**
 - c. **Hardware Type** select **Ethernet**
 - d. Select **OK**

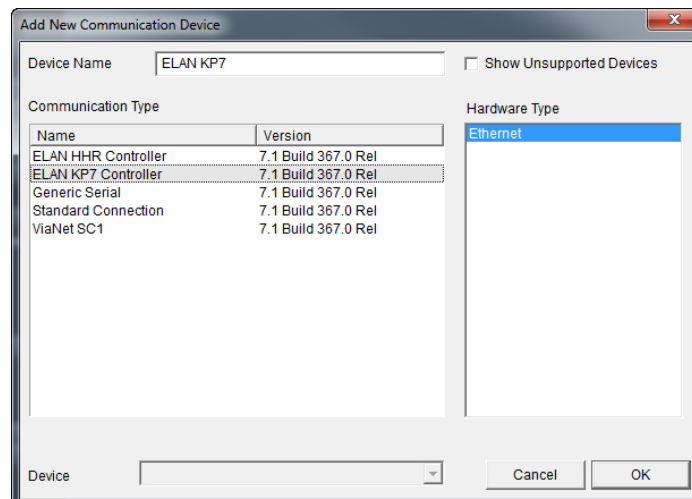

- The MAC ID of each gKP7 will auto-populate in the Interface Devices (KP7) node when powered on and connected to the network.

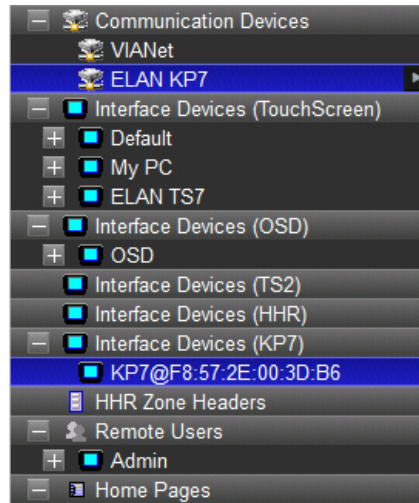

Note: When adding one, or multiple, gKP7s to a project only 1 Communication Device needs to be added to the Interface tab.

- Select the KP7@XX:XX:XX:XX:XX:XX node. The Properties Pane to the right displays the properties for the selected gKP7. **Enter the desired name** for the gKP7 in the **Name** field.

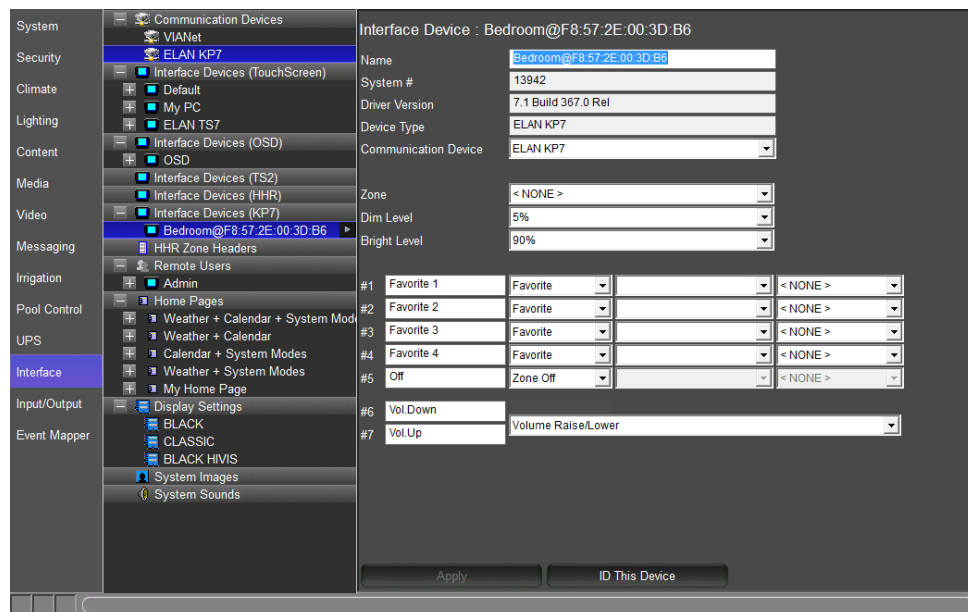

Note: ELAN recommends naming the gKP7 something that easily indicates its location. ELAN also recommends including the MAC ID in the name of the gKP7. Use the **ID This Device** button to begin toggling the lights on and off on the gKP7. The lights will flash for 5 minutes to allow for easy identification of the selected gKP7.

Quick Reference: gKP7 Properties	
Name	Editable field used to name the video display.
System #	Unique, read-only number assigned by the g! software for internal use.
Driver Version	Core module rev the driver was last verified in.
Device Type	Type of Communication Device added
Communication Device	The communication bridge between the g! Software and the ELAN gKP7
Zone	Drop down menu of available media zones in the g! system
Dim Level	Sets the minimum percentage of light intensity when activated from 0% to 25% in increments of 5. Factory default is 5%.
Bright Level	Sets the maximum percentage of light intensity when activated from 75% to 100% in increments of 5. Factory default is 90%.
#1 - 5	5 fully configurable buttons on the gKP7. Factory default Favorite 1-4 & Off.
# 1-5 Drop Downs	<p>Favorite – Sets source and command when button is pressed. Use this setting when using the Press & Hold feature of the gKP7.</p> <p>Favorite (Locked) – Set the source and command when the button is pressed permanently. Use this setting with custom engraved buttons are used or when the Press & Hold feature is not needed.</p> <p>Zone Off – Turns the media zone off. Press and Hold for 3 seconds to turn all media zones off.</p> <p>Light Scene/Link – Assigns a lighting scene/link to a button</p> <p>Light Switch – Assigns a light switch to a button</p> <p>Event Map Only – The buttons are only able to be configured in the Event Mapper tab</p>
#6 & 7	Vol.Down and Vol.Up configurable buttons. Factory Default is Zone volume raise/lower.
#6 & 7 Drop Downs	<p>Volume Raise/Lower – Ramps Zone volume up and down</p> <p>Light Scene/Link Raise/Lower – Adjusts light level for selected scene/link up and down</p> <p>Event Map Only – The buttons are only able to be configured in the Event Mapper tab</p>
ID This Device	Toggles the lights on the gKP7 On and Off for 5 minutes for easy identification of the gKP7.

5. In the **Zone** drop down select the media zone the gKP7 will be linked to. For this exercise select **Bedroom**.
6. Set the **Dim Level** and **Bright Level** as desired.

Zone	Bedroom
Dim Level	5%
Bright Level	90%

Note: The Dim and Bright Level settings are activated in the g! Configurator software and may be used to indicate if a button is activated or de-activated.

These next steps will walk thru setting up a **Favorite button** on the gKP7.

7. Select **Favorite** in the Favorite 1 row.

The screenshot shows a grid of controls for the gKP7. Row #1 is highlighted with a red oval. The controls in row #1 are: 'Favorite 1', a 'Favorite' dropdown menu, a '< SELECT >' dropdown menu, and a '< NONE >' dropdown menu. Rows #2 through #5 follow a similar pattern with 'Favorite 2-4' and 'Off'. Row #6 has 'Vol.Down' and a 'Volume Raise/Lower' dropdown. Row #7 has 'Vol.Up' and the same 'Volume Raise/Lower' dropdown.

a. In the column to the right of Favorite select the desired source to be activated when the button is pressed on the gKP7. For this exercise select **SAT TV**.

This screenshot is identical to the previous one, but the second dropdown menu in row #1 now displays 'SAT TV' instead of '< SELECT >'. This selection is circled in red.

b. Select the last column drop-down and select the desired **TV channel** to tune to when the button is pressed on the gKP7. For this exercise select **ESPN**.

This screenshot is identical to the previous one, but the third dropdown menu in row #1 now displays 'ESPN' instead of '< NONE >'. This selection is circled in red.

Note: When selecting two-way AM/FM tuners, two-way XM/Sirrius tuners, or set top box tuners (cable, satellite, etc) the last column will only populate when Favorites stations are assigned. If a Favorite station assigned to the gKP7 is deleted the button press will stop working.

c. Click **Apply** when finished.

8. Repeat steps 7 thru 7c to configure additional Favorite buttons on the gKP7.

#1	Favorite 1	Favorite	SAT TV	ESPN
#2	Favorite 2	Favorite	Sirius Tuner	Hair Nation
#3	Favorite 3	Favorite	< NONE >	< NONE >
#4	Favorite 4	Favorite	< NONE >	< NONE >
#5	Off	Zone Off	< NONE >	< NONE >
#6	Vol.Down	Volume Raise/Lower		< NONE >
#7	Vol.Up			< NONE >

Note: Use Favorite (Locked) if the Favorite setting never needs to be changed. Such as when using custom engraved buttons like Pandora or Spotify.

These next steps will walk thru how to setup a button on the gKP7 to control a **Light Scene/Link**.

9. In one of the unused Favorites row select the Favorite drop-down and select **Light Scene/Link**.

#1	Favorite 1	Favorite	SAT TV	ESPN
#2	Favorite 2	Favorite	Sirius Tuner	Hair Nation
#3	Favorite 3	Favorite	< NONE >	< NONE >
#4	Favorite 4	Favorite	< NONE >	< NONE >
#5	Off	Favorite Favorite (Locked) Zone Off Light Scene/Link Light Switch Event Map Only	< NONE >	< NONE >
#6	Vol.Down			< NONE >
#7	Vol.Up			< NONE >

- a. In the column to the right of Light Scene/Link select the desired **lighting Scene/Link** to be activated when the button is pressed on the gKP7.

#1	Favorite 1	Favorite	SAT TV	ESPN
#2	Favorite 2	Favorite	Sirius Tuner	Hair Nation
#3	Favorite 3	Light Scene/Link	All Off	< NONE >
#4	Favorite 4	Favorite	< NONE >	< NONE >
#5	Off	Zone Off	< NONE >	< NONE >
#6	Vol.Down			< NONE >
#7	Vol.Up	Volume Raise/Lower		< NONE >

- b. Click **Apply** when finished.

10. Repeat steps 9 thru 9b to configure additional Light Scene/Link buttons on the gKP7.

These next steps will walk thru how to setup a button on the gKP7 to control a **Light Switch**.

11. In one of the unused Favorites row select the Favorite drop-down and select **Light Switch**.

#1	Favorite 1	Favorite	SAT TV	ABC
#2	Favorite 2	Favorite	Sirius Tuner	Hair Nation
#3	Favorite 3	Light Scene/Link	All Off	< NONE >
#4	Favorite 4	Light Switch	< NONE >	< NONE >
#5	Off	Favorite	< SELECT >	< NONE >
#6	Vol.Down	Zone Off		
#7	Vol.Up	Light Scene/Link		

- a. In the column to the right of Light Scene/Link select the desired **lighting switch** to be toggled on and off for each button press on the gKP7.

#1	Favorite 1	Favorite	SAT TV	ABC
#2	Favorite 2	Favorite	Sirius Tuner	Hair Nation
#3	Favorite 3	Light Scene/Link	All Off	< NONE >
#4	Favorite 4	Light Switch	Front Porch	< NONE >
#5	Off	Zone Off	< SELECT >	< NONE >
#6	Vol.Down			
#7	Vol.Up	Volume Raise/Lower		

- b. Click **Apply** when finished.

12. Repeat steps 11 thru 11b to configure additional Light Scene/Link buttons on the gKP7.

These next steps will walk thru how to setup an **Event Map Only** button on the gKP7. The event being created for these steps will be a Goodnight event. This will power off all lighting, power off all media zones, and secure the residence.

- In one of the unused Favorites row select the Favorite drop-down and select **Event Map Only**. Repeat to change additional buttons to Event Map Only.

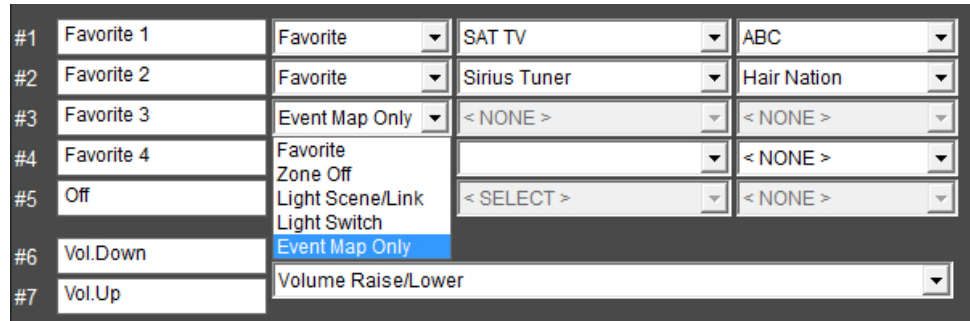

- Select Apply when finished.

- Right click on the **KP7@XX-XX-XX-XX-XX-XX** node, select **Create Event Map For**, and click **[Favorite 3] Pressed**.

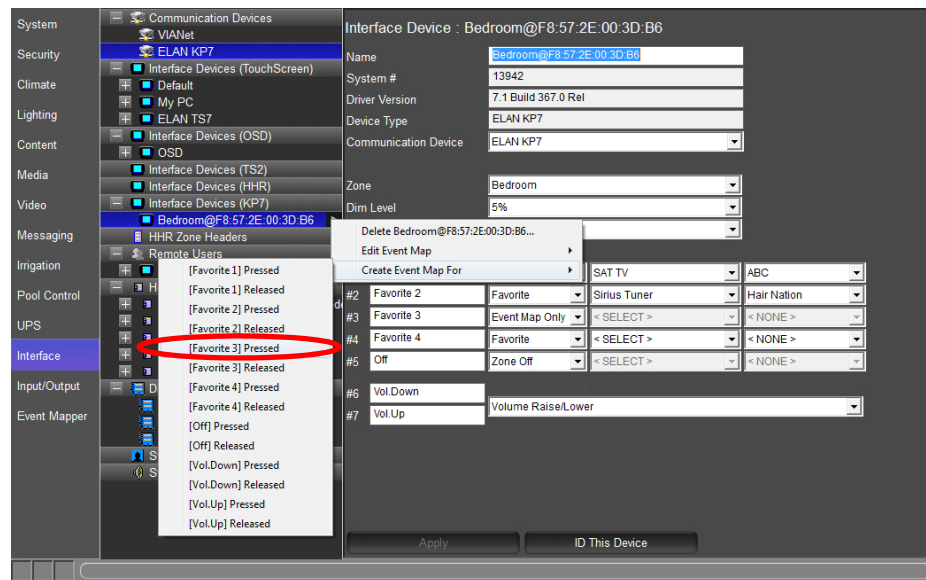

- Rename the Event in the **Create New Event Map** window click **OK**. For this exercise use **KP7 Goodnight**.

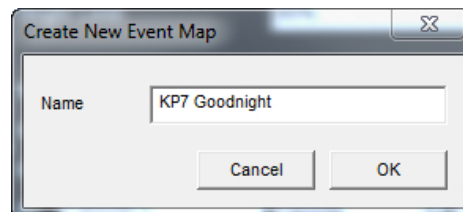

17. For these next steps we will add a command to turn off all the lighting.

- a. In the **Commands** section of the Edit Event Map window select **Add**.

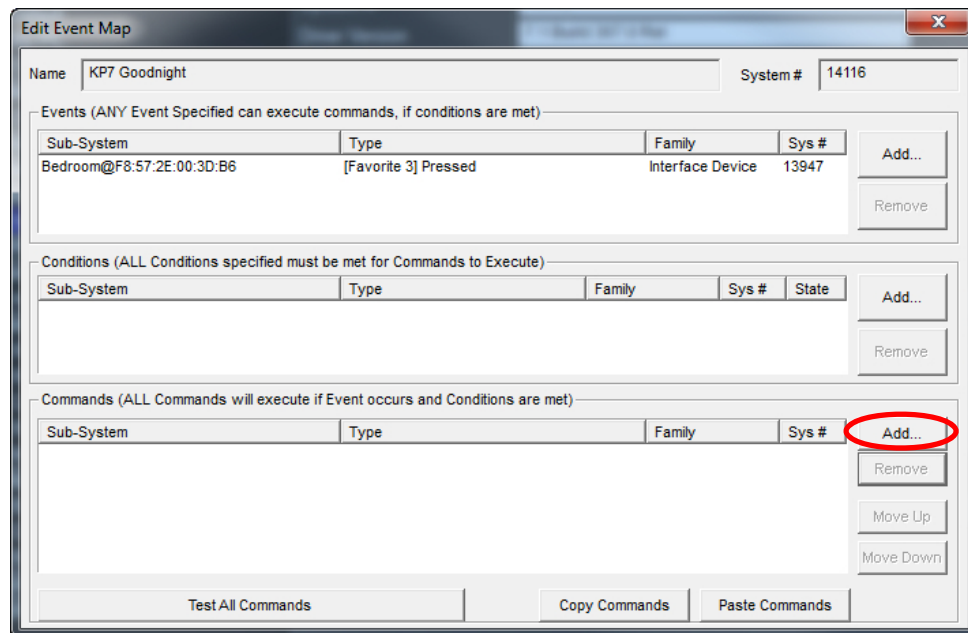

- b. Select the System Family **Lighting System**.
- c. Select the Command Group **Switch/Dimmer: All Off**.
- d. Select the Available Commands **On**.
- e. Click **OK** when finished.

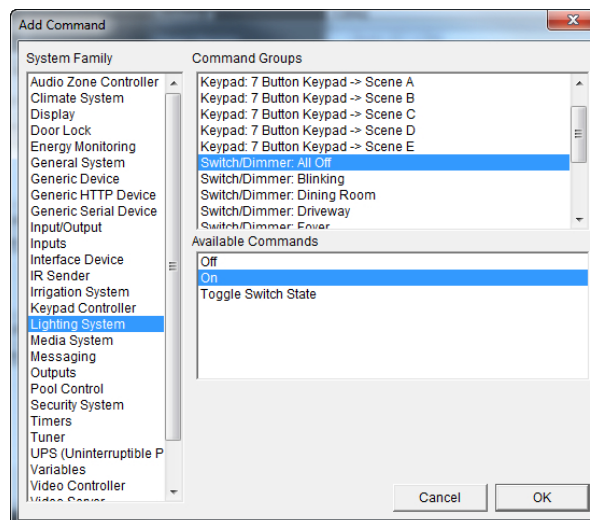

18. For these next steps we will add a command to turn off all the media zones.
 - a. In the **Commands** section of the Edit Event Map window select **Add**.
 - b. Select the System Family **Audio Zone Controller**.
 - c. Select the Command Group **ELAN S86A/P**.
 - d. Select the Available Commands **Do Global Command**.
 - e. Select the Options drop-down item **All Zones Off**.
 - f. Click **OK** when finished.

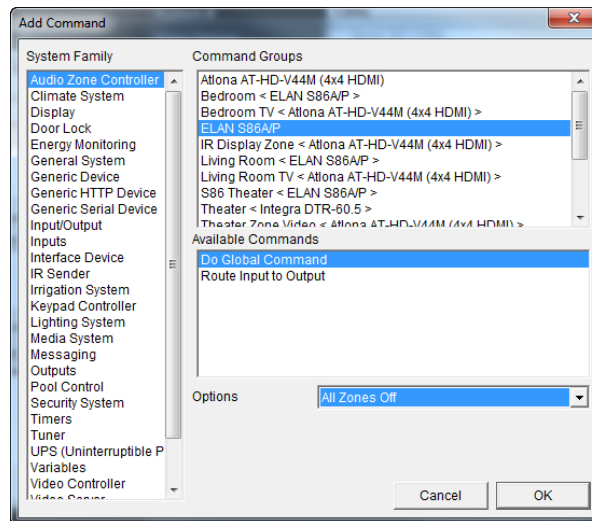

19. For these next steps we will add commands to lock all the doors and arm the security system.
 - a. In the **Commands** section of the Edit Event Map window select **Add**.
 - b. Select the System Family **Door Lock**.
 - c. Select the Command Group **Door Locks**.
 - d. Select the Available Commands **Secure all locks**.
 - e. Click **OK** when finished.

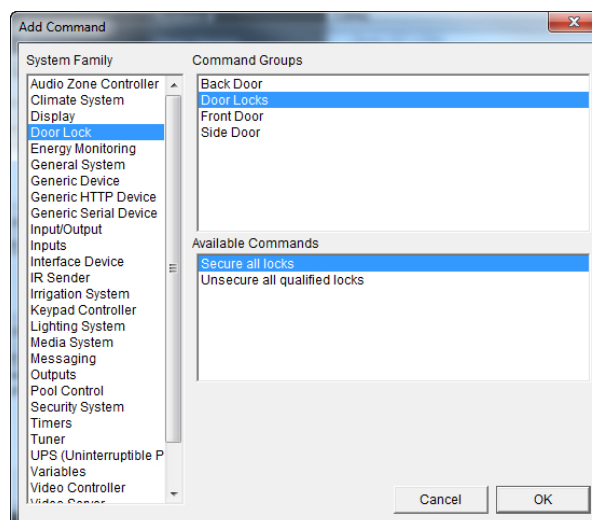

- f. In the **Commands** section of the Edit Event Map window select **Add**.
- g. Select the System Family **Security System**.
- h. Select the Command Group **House**.
- i. Select the Available Commands **Auto Arm in Night Mode**.
- j. Click **OK** when finished.

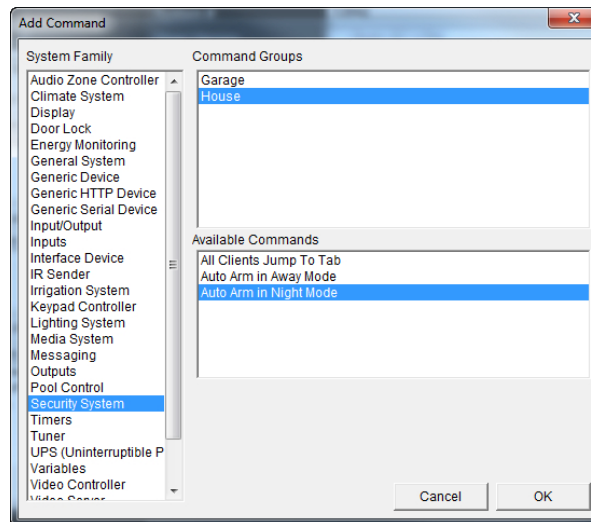









20. When finished, close the Edit Event Map window by clicking  (the red x).

Note: This Event Map Only example shows that when the button is pressed the lighting system will turn off all lights, the media system will turn off all zones, including video displays tied to a media zones, lock all the doors, and arm the security system in Night mode. This event map may differ due to available systems in your project.

Exercise 6: Adding and Configuring a TS2

Overview The TS2 is a small, in-wall keypad style interface that can provide basic control of security, climate, lighting, and media for a specific area or zone rather than the entire system. To configure this interface, first connect and add the keypad to the system, then specify the specific partition, thermostat, lighting keypad, and zone that it will control.

The TS2 communicates to the system using ELAN's ViaNet communication bus. The TS2(s) must be connected to the system properly before configuration. Run Category cable from each TS2 location to the head-end and terminate the TS2 location to the ViaNet pin out:

1 Blue		Not Used
2 White/Blue		Not Used
3 Orange		VIA!Net Negative
4 White/Orange		VIA!Net Positive
5 Green		Not Used
6 White/Green		Not Used
7 Brown		Ground
8 White/Brown		+12V or +16V

Connect category cable at the head-end equipment location to the PPVN. The PPVN provides power to the TS2(s). The ViaNet port on the front of the PPVN will connect to the ViaNet port on the SC-1. The SC-1's RS232 port will connect to an available serial port on the g System Controller. Please refer to the SC-1 manual for more information.

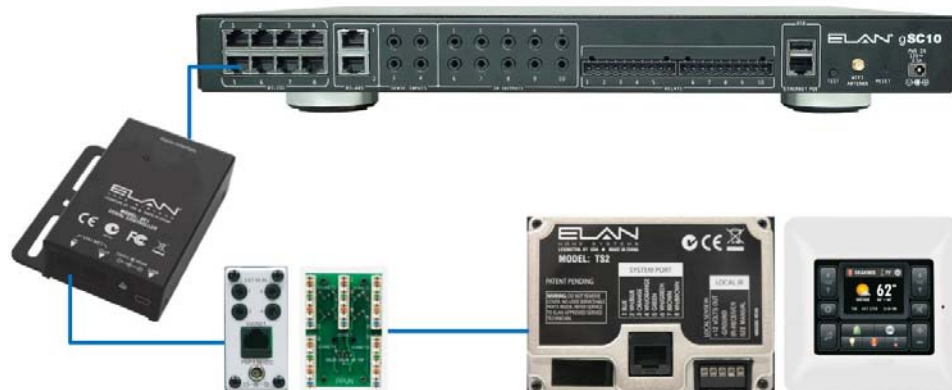

How-to

To add a TS2 interface from the Configurator **Interface** tab:

1. Right-click **Communication Devices** and select **Add New Communication Device**. In the dialog box:
 - a. Enter “VIANET” as the **Device Name**
 - b. **Communication Type** select **ViaNet SC1**
 - c. **Hardware Type** select **Serial Port**
 - d. Select an **Unassigned** COM Port in the **COM Port** drop down
 - e. Click **OK**

Note: TS2 keypads communicate over ViaNet and requires the use of the SC-1. The SC-1 provides the serial to ViaNet translation and connect to a serial port on the g! System controller.

2. The TS2(s) will automatically populate in Interface Devices (TS2) when first powered on.

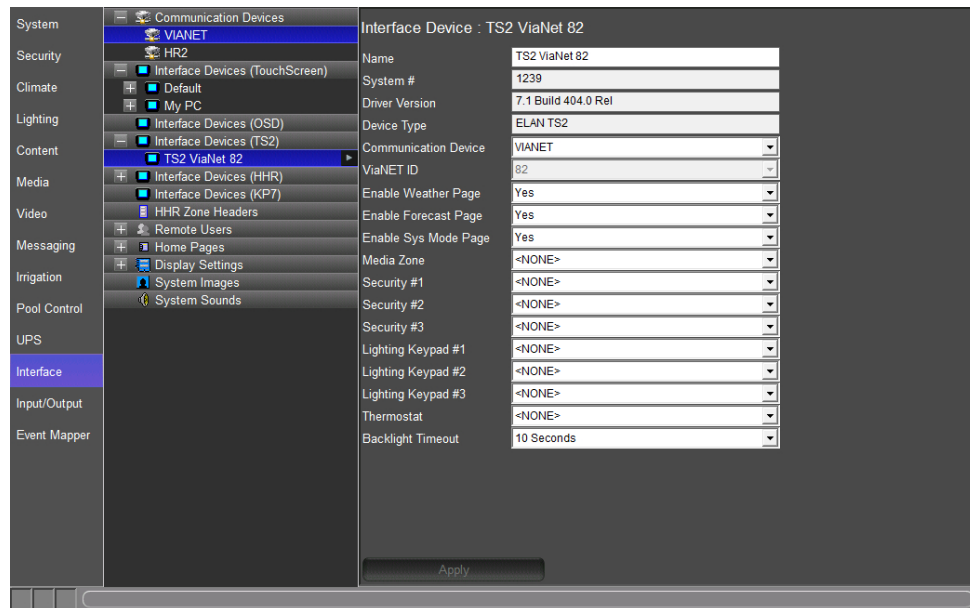

3. Configure options for the TS2 interface as described in the following table.

Field	Description
Name	Editable field to name the device
System #	System-assigned number. Cannot be changed.
Device Type	Pre-filled with device type selected when adding this device. Cannot be changed.
Communication Device	Select the communication device for this interface.
ViaNET ID	System-provided ID. Cannot be changed.
Enable Weather Page	Select Yes or No whether to display the weather info on the home page

Enable Forecast Page	Select Yes or No whether to display a weather forecast on the TS2 device.
Enable Sys Mode Page	Select Yes or No whether to display the page that allows House Mode selection.
Media Zone	Select the Media Zone for this TS2 device.
Security Partition #1 - 3	Select the Security Partition for this TS2 device.
Lighting Keypad #1 - 3	Select the Lighting Keypad for this TS2 device.
Thermostat	Select the Thermostat for this TS2 device.
Backlight Timeout	Select the period of time that this device will remain illuminated without interaction.

4. When configuring media interfaces for source control on a TS2, you must be sure that you create your controls/mapping on the TS2 resolution that is available when you create a new interface under **Sources** on the **Media** tab. For this exercise select **Satellite Box** that was added in an earlier exercise.
 - a. Under the TS2 interface, select the Guide page.
 - b. Click the Guide button to verify its properties in the newly opened window. Guide should be listed as the Universal Function for this button.

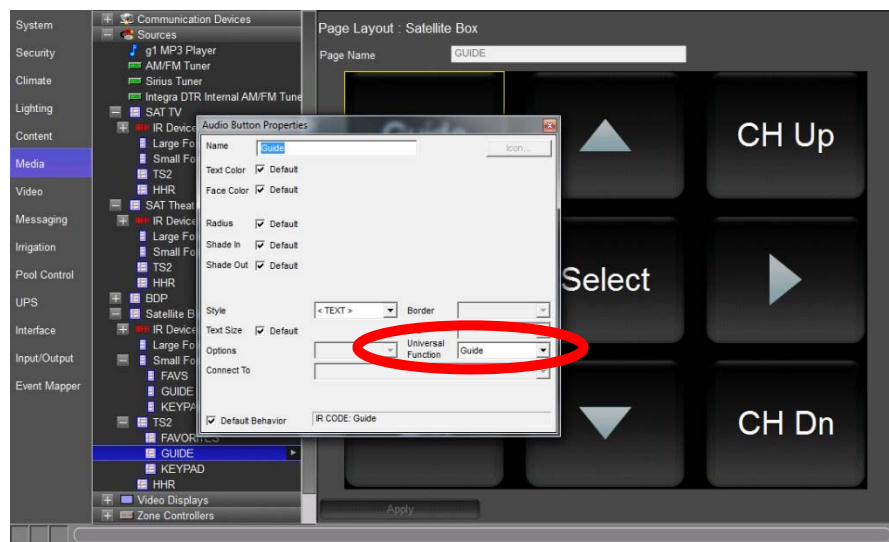

- c. Click the other buttons to verify that their function is mapped properly.

In addition, the TS2 uses a special control to handle TV Channel Favorites that requires some additional configuration. Rather than display a page with all favorites as on larger touchscreens, the TS2 allows you to select individual channel buttons and the templates will typically have a page with 9 Channel Favorite Buttons pre-populated.

- Choose the channels the customer will watch frequently, and manually assign the desired channel on the Favorites page under the TS2 resolution for the desired source interface. For this exercise, select the TS2 Favorites under **Media>Sources>Satellite Box>TS2>Favorites**.

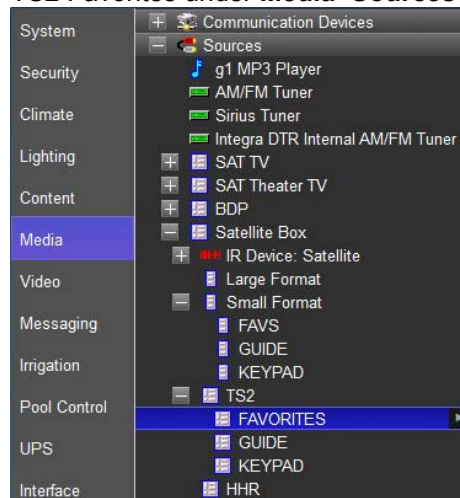

- Click a button on the TS2 Favorites interface to display the TV Channel Favorites Properties window. From the **Connect To** dropdown, choose the desired channel. Click **Apply** when done.

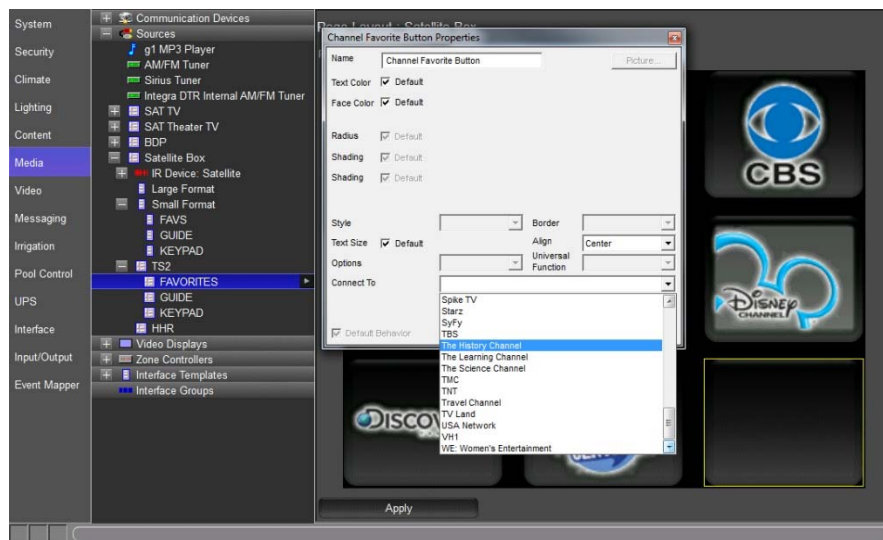

7. When configuring Lighting Keypads for control from a TS2, note the following:
- Only Keypads can be added (no Custom Tabs)
 - It is recommended to build special Virtual Keypads on the Lighting Tab for lighting devices you wish to control from a TS2. There are special Keypad Templates to match the TS2 screen.
 - Sample settings when adding a Virtual Keypad for Lighting control from a TS2:

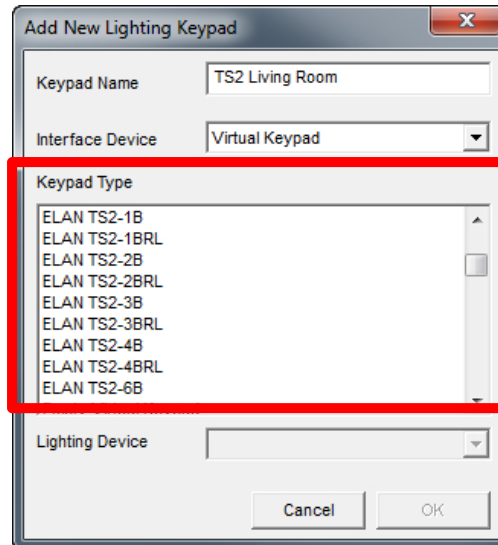

See the Lighting Lesson for more details on using Virtual Keypads. The above selection will add a 3-Button layout that is sized for the TS2's LCD.

Exercise 7: Configuring the gTP7

Overview The gTP7 is a 7" Touch Panel that fits in a dual gang box and is powered with PoE, Power over Ethernet. The gTP7 is IEEE 802.3at compliant and may be used with PoE injectors or PoE switches.

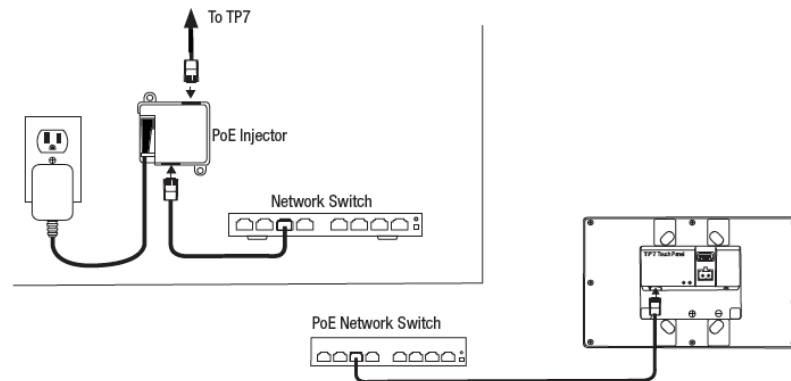

The gTP7 can control one, multiple, or all media zones. The gTP7 features a 7 button fly out that pops up when the touch panel is awoken. The 7 button fly out allows the end-user to conveniently store and recall stations from any g! supported two-way tuner, playlists from an ELAN g! MP3 player, channels and playlists from compatible streaming content devices (Autonomic, LMS, & Sonos), as well as accessing and initiating playback from legacy devices like CD players and satellite boxes.

Before installing the gTP7 note the MAC ID on the lower left rear corner. ELAN recommends writing down the MAC ID number and the location name where the gTP7 will be installed.

Once the gTP7 is installed ensure the unit is powered on and then access the g! Configurator.

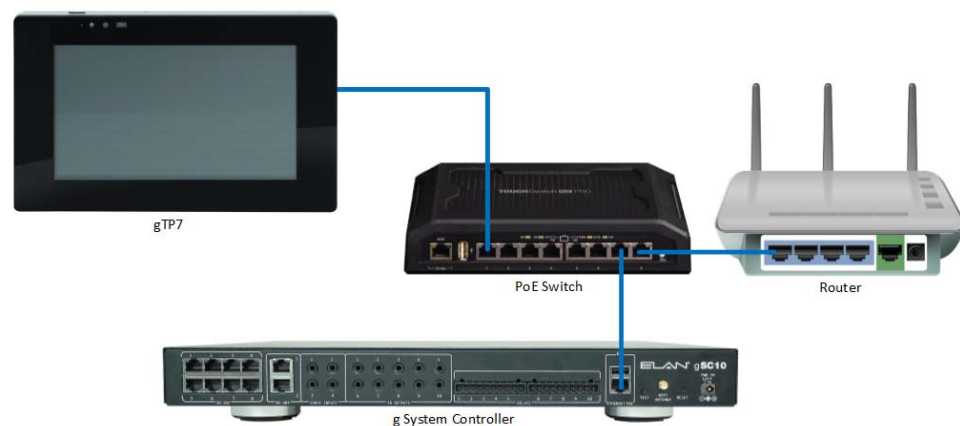

Note: The gTP7 may be powered over PoE or with a 12V 1A power supply (power supply not included).

How-to

Add and configure the gTP7

1. Start the **Configurator**, click the **Interface** tab at left.
2. In the **Interface Devices (TouchScreen)** node verify the **gTP7** auto-populated.

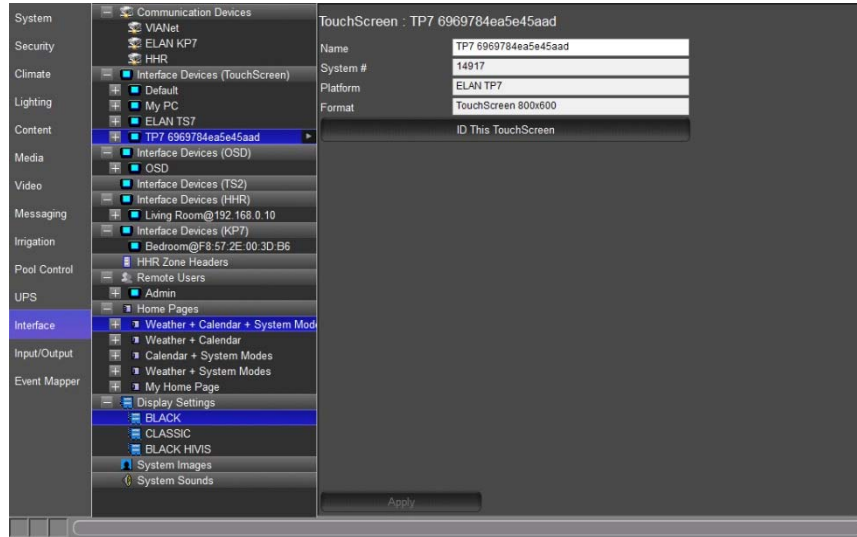

3. Select the **TP7** node and name the gTP7 something that is easily recognizable. For this exercise name the gTP7 **TP7 Living Room**.

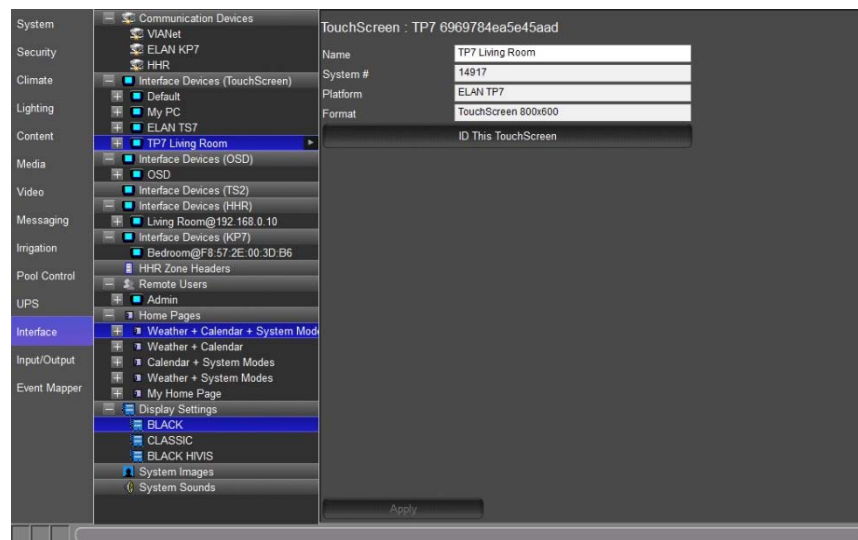

4. Select **Apply** when finished.

Note: ELAN recommends naming the gTP7 something that easily indicates its location. Use the **ID This TouchScreen** button to display the name of the gTP7 for 5 seconds to allow for easy identification of the selected gTP7.

5. Click the **(+)** sign to the left of the TP7 Living Room node to view all the setting options.

6. Select Flyout Settings.

Quick Reference: gTP7 Flyout Settings	
Enable Auto-Flyout On Screen Activate	Set to Yes to enable the 7 button flyout. Set to No to disable the 7 button flyout.
Audio Zone Must Be Active	Set to Yes to require the audio zone be On for the flyout to appear. Set to No to allow the flyout to appear if the audio zone is On or Off.
Leave Screen Save Up	Set to Yes when using the photo slideshow option to allow the 7 button flyout to appear on top of the photo slideshow. Set to No to exit the photo slide show when the 7 button flyout appears.
Prox Sensor Timeout	Sets the proximity sensor to timeout after the gTP7 is activated after 1, 2, 3, 4, 5, 10, 20, 30, 40, 50, or 60 seconds.
Swipe Timeout	Sets the 7 button flyout to timeout once activated after 10, 20, 30, 40, 50, or 60 seconds.
Default Zone	Drop down menu of available media zones in the g! system
#1 - 5	5 fully configurable buttons on the gTP7. Factory default Favorite 1-4 & Off.
# 1-5 Drop Downs	<p>Favorite – Sets source and command when button is pressed. Use this setting when using the Press & Hold feature of the gTP7.</p> <p>Favorite (Locked) – Set the source and command when the button is pressed permanently. Use this setting with custom engraved buttons are used or when the Press & Hold feature is not needed.</p> <p>Zone Off – Turns the media zone off. Press and Hold for 3 seconds to turn all media zones off.</p> <p>Light Scene/Link – Assigns a lighting scene/link to a button</p> <p>Light Switch – Assigns a light switch to a button</p> <p>Event Map Only – The buttons are only able to be configured in the Event Mapper tab</p>
#6 & 7	Vol.Down and Vol.Up configurable buttons. Factory Default is Zone volume raise/lower.

#6 & 7 Drop Downs	<p>Volume Raise/Lower – Ramps Zone volume up and down</p> <p>Light Scene/Link Raise/Lower – Adjusts light level for selected scene/link up and down</p> <p>Event Map Only – The buttons are only able to be configured in the Event Mapper tab</p>
-------------------	---

7. Set the **Enable Auto-Flyout On Screen Activate** drop down to **Yes**. *This will enable the 7 button flyout. Set to No to disable the 7 button flyout.*
8. Set the **Audio Zone Must Be Active** drop down to **No**. *This will allow the 7 button flyout to appear if the audio zone is on or off. Set to Yes if the 7 button flyout will only be needed while the audio zone is on.*
9. Set the **Leave Screen Save Up** drop down to **No**. *This will exit the photo slide show, or screen saver, when the 7 button flyout is activated. Set to No if the 7 button flyout show appear as a layover of the photo slideshow, or screen saver.*
10. Set the **Prox Sensor Timeout** and the **Swipe Timeout** as desired. For this exercise we will leave the setting at the factory default setting of **5 sec** and **60 sec**.
11. In the **Default Zone** drop down select the media zone the gTP7 will be linked to. For this exercise select **Living Room**. *Setting the media zone will enable the Favorite buttons to be configured for control of media devices in the selected zone.*

Flyout Settings

Enable Auto-Flyout On Screen Activate Yes

Audio Zone Must Be Active No

Leave Screen Saver Up No

Prox Sensor Timeout 5 sec

Swipe Timeout 60 sec

Default Zone Living Room

These next steps will walk thru setting up a **Favorite button** on the gTP7.

12. Select **Favorite** in the Favorite 1 row.

#1	Favorite 1	Favorite	< SELECT >	< NONE >
#2	Favorite 2	Favorite	< SELECT >	< NONE >
#3	Favorite 3	Favorite	< SELECT >	< NONE >
#4	Favorite 4	Favorite	< SELECT >	< NONE >
#5	Off	Zone Off	< SELECT >	< NONE >
#6	Vol.Down			
#7	Vol.Up	Volume Raise/Lower		

- a. In the column to the right of Favorite select the desired source to be activated when the button is pressed on the gTP7. For this exercise select **SAT TV**.

#1	Favorite 1	Favorite	SAT TV	NONE >
#2	Favorite 2	Favorite	< SELECT >	< NONE >
#3	Favorite 3	Favorite	< SELECT >	< NONE >
#4	Favorite 4	Favorite	< SELECT >	< NONE >
#5	Off	Zone Off	< SELECT >	< NONE >
#6	Vol.Down	Volume Raise/Lower		
#7	Vol.Up	Volume Raise/Lower		

- b. Select the last column drop-down and select the desired **TV channel** to tune to when the button is pressed on the gTP7. For this exercise select **ESPN**.

#1	Favorite 1	Favorite	SAT TV	ESPN
#2	Favorite 2	Favorite	< SELECT >	< NONE >
#3	Favorite 3	Favorite	< SELECT >	< NONE >
#4	Favorite 4	Favorite	< SELECT >	< NONE >
#5	Off	Zone Off	< SELECT >	< NONE >
#6	Vol.Down	Volume Raise/Lower		
#7	Vol.Up	Volume Raise/Lower		

Note: When selecting two-way AM/FM tuners, two-way XM/Sirrius tuners, or set top box tuners (cable, satellite, etc) the last column will only populate when Favorites stations are assigned. If a Favorite station assigned to the gTP7 is deleted the button press will stop working.

- c. Click **Apply** when finished.

13. Repeat steps 7 thru 7c to configure additional Favorite buttons on the gTP7.

#1	Favorite 1	Favorite	SAT TV	ESPN
#2	Favorite 2	Favorite	Sirius Tuner	Hair Nation
#3	Favorite 3	Favorite	< NONE >	< NONE >
#4	Favorite 4	Favorite	< NONE >	< NONE >
#5	Off	Zone Off	< NONE >	< NONE >
#6	Vol.Down	Volume Raise/Lower		< NONE >
#7	Vol.Up			< NONE >

Note: Use Favorite (Locked) if the Favorite setting never needs to be changed. Such as when using custom engraved buttons like Pandora or Spotify.

These next steps will walk thru how to setup a button on the gTP7 to control a **Light Scene/Link**.

14. In one of the unused Favorites row select the Favorite drop-down and select **Light Scene/Link**.

#1	Favorite 1	Favorite	SAT TV	ESPN
#2	Favorite 2	Favorite	Sirius Tuner	Hair Nation
#3	Favorite 3	Favorite	< NONE >	< NONE >
#4	Favorite 4	Favorite	< NONE >	< NONE >
#5	Off	Favorite Favorite (Locked) Zone Off Light Scene/Link Light Switch Event Map Only	< NONE >	< NONE >
#6	Vol.Down			< NONE >
#7	Vol.Up			< NONE >

a. In the column to the right of Light Scene/Link select the desired **lighting Scene/Link** to be activated when the button is pressed on the gTP7.

#1	Favorite 1	Favorite	SAT TV	ESPN
#2	Favorite 2	Favorite	Sirius Tuner	Hair Nation
#3	Favorite 3	Light Scene/Link	All Off	< NONE >
#4	Favorite 4	Favorite	< NONE >	< NONE >
#5	Off	Zone Off	< NONE >	< NONE >
#6	Vol.Down			< NONE >
#7	Vol.Up	Volume Raise/Lower		< NONE >

b. Click **Apply** when finished.

15. Repeat steps 9 thru 9b to configure additional Light Scene/Link buttons on the gTP7.

These next steps will walk thru how to setup a button on the gTP7 to control a **Light Switch**.

16. In one of the unused Favorites row select the Favorite drop-down and select **Light Switch**.

#1	Favorite 1	Favorite	SAT TV	ABC
#2	Favorite 2	Favorite	Sirius Tuner	Hair Nation
#3	Favorite 3	Light Scene/Link	All Off	< NONE >
#4	Favorite 4	Light Switch	< NONE >	< NONE >
#5	Off	Favorite	< SELECT >	< NONE >
		Zone Off		
#6	Vol.Down	Light Scene/Link		
		Light Switch		
#7	Vol.Up	Event Map Only		

- a. In the column to the right of Light Scene/Link select the desired **lighting switch** to be toggled on and off for each button press on the gTP7.

#1	Favorite 1	Favorite	SAT TV	ABC
#2	Favorite 2	Favorite	Sirius Tuner	Hair Nation
#3	Favorite 3	Light Scene/Link	All Off	< NONE >
#4	Favorite 4	Light Switch	Front Porch	< NONE >
#5	Off	Zone Off	< SELECT >	< NONE >
#6	Vol.Down			
#7	Vol.Up	Volume Raise/Lower		

- b. Click **Apply** when finished.

17. Repeat steps 11 thru 11b to configure additional Light Scene/Link buttons on the gTP7.

These next steps will walk thru how to setup an **Event Map Only** button on the gTP7. The event being created for these steps will be a Goodnight event. This will power off all lighting, power off all media zones, and secure the residence.

- In one of the unused Favorites row select the Favorite drop-down and select **Event Map Only**. Repeat to change additional buttons to Event Map Only.

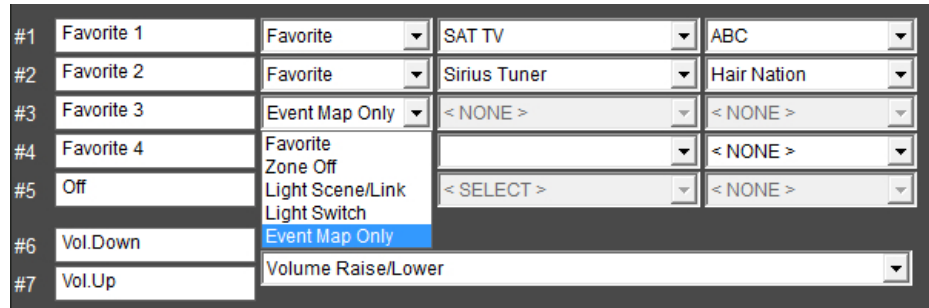

- Select Apply when finished.

- Right click on the **KP7@XX-XX-XX-XX-XX-XX** node, select **Create Event Map For**, and click **[Favorite 3] Pressed**.

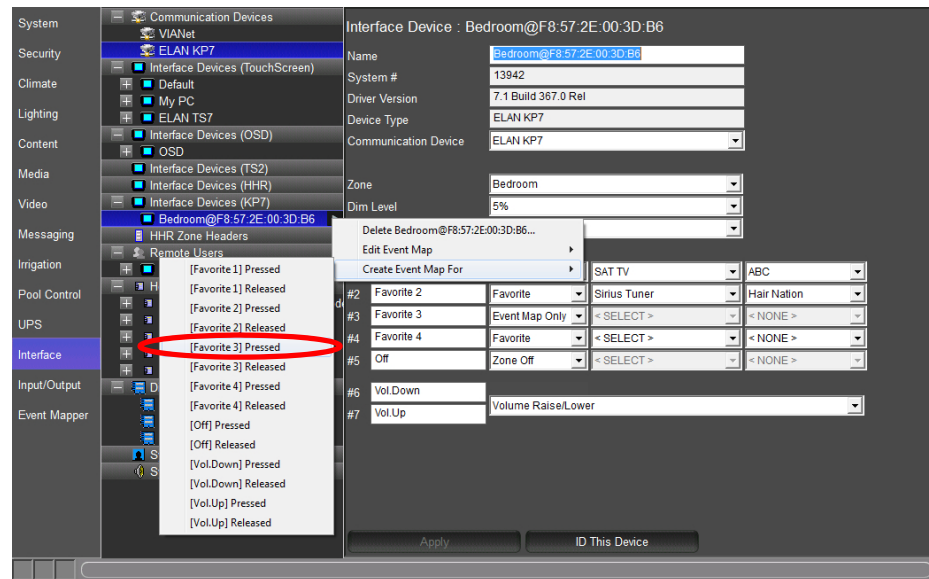

- Rename the Event in the **Create New Event Map** window click **OK**. For this exercise use **KP7 Goodnight**.

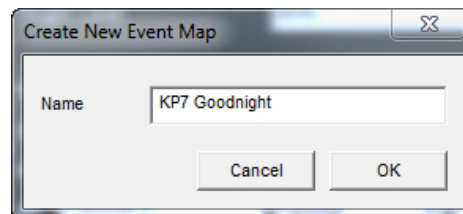

22. For these next steps we will add a command to turn off all the lighting.

- a. In the **Commands** section of the Edit Event Map window select **Add**.

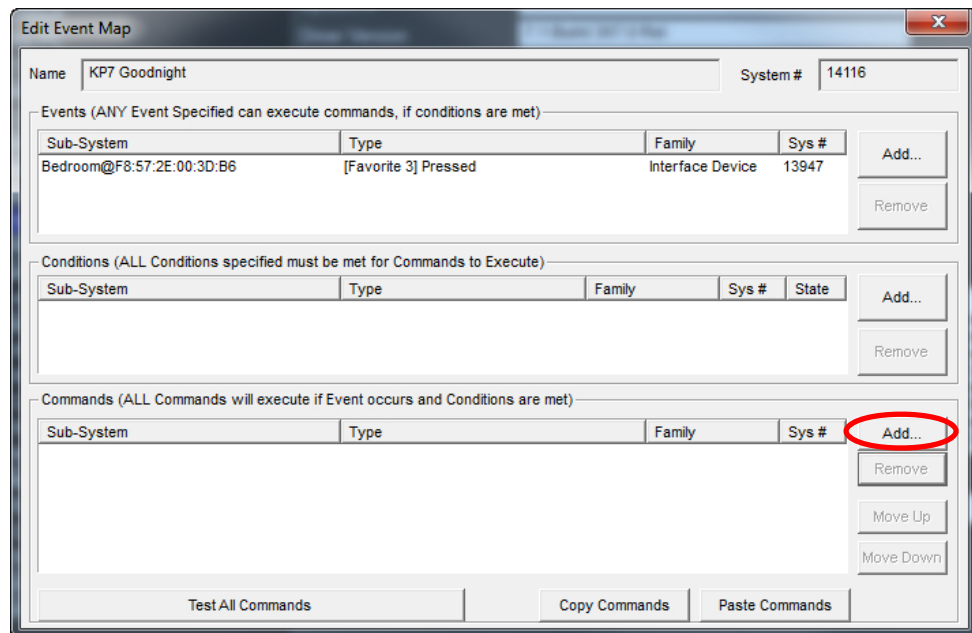

- b. Select the System Family **Lighting System**.
- c. Select the Command Group **Switch/Dimmer: All Off**.
- d. Select the Available Commands **On**.
- e. Click **OK** when finished.

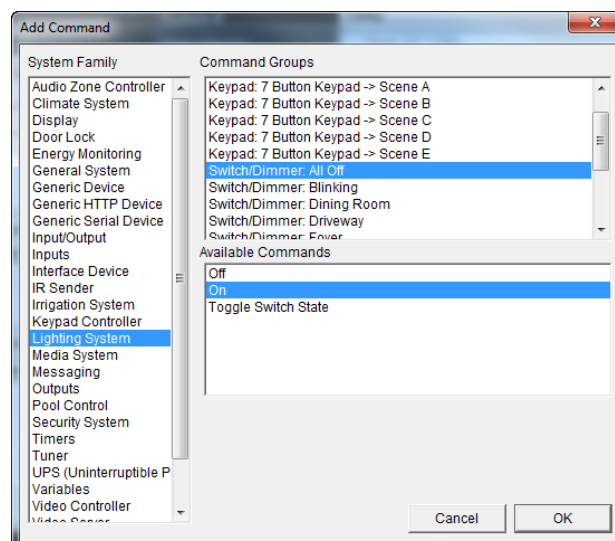

23. For these next steps we will add a command to turn off all the media zones.
- In the **Commands** section of the Edit Event Map window select **Add**.
 - Select the System Family **Audio Zone Controller**.
 - Select the Command Group **ELAN S86A/P**.
 - Select the Available Commands **Do Global Command**.
 - Select the Options drop-down item **All Zones Off**.
 - Click **OK** when finished.

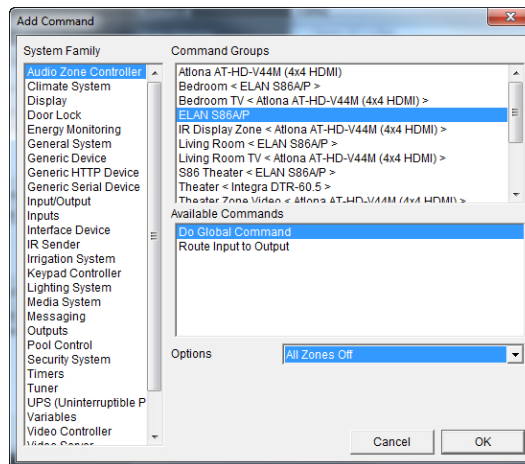

24. For these next steps we will add commands to lock all the doors and arm the security system.
- In the **Commands** section of the Edit Event Map window select **Add**.
 - Select the System Family **Door Lock**.
 - Select the Command Group **Door Locks**.
 - Select the Available Commands **Secure all locks**.
 - Click **OK** when finished.

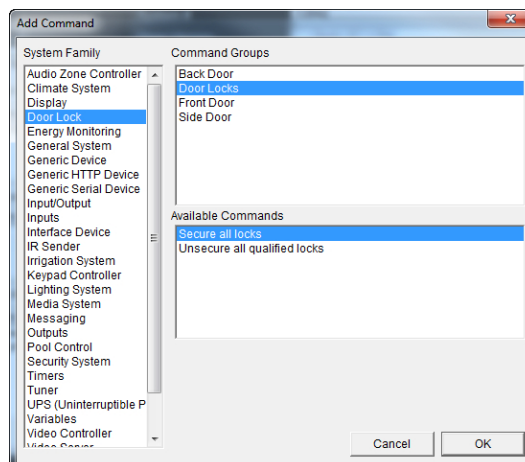

- f. In the **Commands** section of the Edit Event Map window select **Add**.
- g. Select the System Family **Security System**.
- h. Select the Command Group **House**.
- i. Select the Available Commands **Auto Arm in Night Mode**.
- j. Click **OK** when finished.

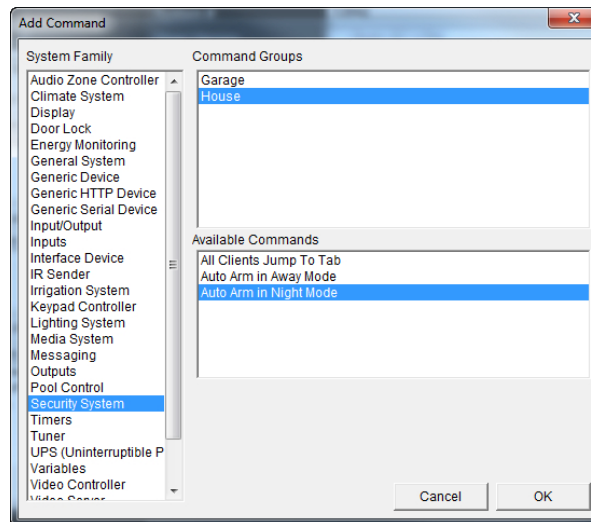

25. When finished, close the Edit Event Map window by clicking  (the red x).

Note: This Event Map Only example shows that when the button is pressed the lighting system will turn off all lights, the media system will turn off all zones, including video displays tied to a media zones, lock all the doors, and arm the security system in Night mode. This event map may differ due to available systems in your project.

Exercise 8: Configuring TS7/TS10/Valet 10 Touchscreens

Overview

The ELAN TS7, TS10, and Valet10 are interfaces that include the following features:

- IP based communication
- 7 inch (TS7) or 10 inch (TS10) diagonal touchscreen. The TS7 and TS10 are in-wall; the Valet10 is mounted externally.
- 800x480 resolution (Large Format > LARGE LANDSCAPE (WIDE))
- Composite video input
- Hard buttons for direct control of Media and Lighting.

To configure a TS7/TS10/Valet10, simply connect it to the g! controller network and power up the unit. An entry for the TS7/TS10/Valet10 is automatically added to the Configurator on the Interface tab.

Note: The g!Demo software will automatically add one TS7 Touchscreen to the system. In an actual system, the TS7/TS10/Valet10s will be added as they are connected to the system.



*How-to***Media Hard Buttons**

To configure the Media Hard Buttons on a TS7/TS10 touchscreen, navigate to the Configurator **Interface** Tab:

1. Under **Interface Devices (TouchScreen)**, click the “+” next to the entry labeled **ELAN TS7** or **ELAN TS10** to expand the list.
2. Verify this item is the screen that you are trying to configure using the **ID This TouchScreen** button as described in Exercise 1 at the beginning of this lesson.
3. Select the entry labeled **Tab Config: Media System**.
4. In the Properties pane, use the **Default Tab** dropdown to select the Media Zone where the screen is located that the hard buttons will control. For training purposes, select the Living Room zone. Selecting a zone here has the following effects:
 - a. The “♪ PWR” hard button on the panel will automatically be mapped to toggle power for the zone. If the zone is not currently showing in the Viewer, you will be taken to the zone. Additionally, pressing and holding this button will execute All Zones Off.
 - b. The “Up Arrow” and “Down Arrow” hard buttons will automatically be mapped to ramp volume up and down for the zone.
 - c. The “Mute” button will be automatically mapped to the Mute Toggle command for the zone.

Light Hard Button

The Light hard button on the TS7/TS10/Valet10 is configured using Event Maps, and can be used to toggle a lighting load or lighting scene. When the button is pressed, the system receives a “Light Button Down” message from the screen. When it is released, the system receives a “Light Button Up” message. These messages are the Events in the event mapper.

1. From the **Interface** tab, right click the **ELAN TS7** or **ELAN TS10** entry and select **Create Event Map For > Light Button Down** option. *The Create New Event Map window will open, with the name “ELAN TS7 (or TS10):Light Button Down” pre-filled:*

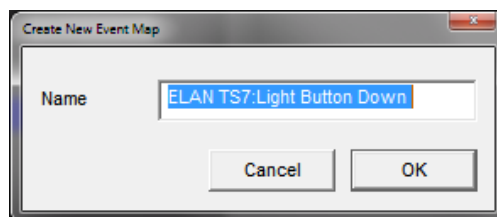

- Click the **OK** button to accept the name and open the **Edit Event Map** window. The Event section is automatically pre-filled with the button press command as seen in the image below:

Edit Event Map

Name: ELAN TS7:Light Button Down System #: 3740

Events (ANY Event Specified can execute commands, if conditions are met)

Sub-System	Type	Family	Sys #	
Client: ELAN TS7	Light Button Down	General System	2500	Add... Remove

Conditions (ALL Conditions specified must be met for Commands to Execute)

Sub-System	Type	Family	Sys #	State	
------------	------	--------	-------	-------	--

Commands (ALL Commands will execute if Event occurs and Conditions are met)

Sub-System	Type	Family	Sys #	
------------	------	--------	-------	--

Test All Commands

- To add a lighting command, click the **Add** button next to the **Commands** section of the window. *The Add Command window will be displayed:*

Add Event

System Family

- Audio Zone Controller
- Climate System
- Display
- Door Lock
- Energy Monitoring
- General System
- Generic Device
- Generic HTTP Device
- Generic Serial Device
- Input/Output
- Inputs
- Interface Device
- IR Sender
- Irrigation System
- Keypad Controller
- Lighting System
- Media System
- Messaging
- Outputs
- Pool Control
- Security System
- Timers
- Tuner
- UPS (Uninterruptible P
- Variables
- Video Controller
- Video Sensor

Event Groups

Available Events

Cancel OK

4. From the **System Family** section, select **Lighting System**. If you have completed Lesson 5: Lighting, the devices added in that lesson will be shown. In the Command Groups window, select **Keypad: Master-> On** then select **Activate Scene** from the Available Commands list:

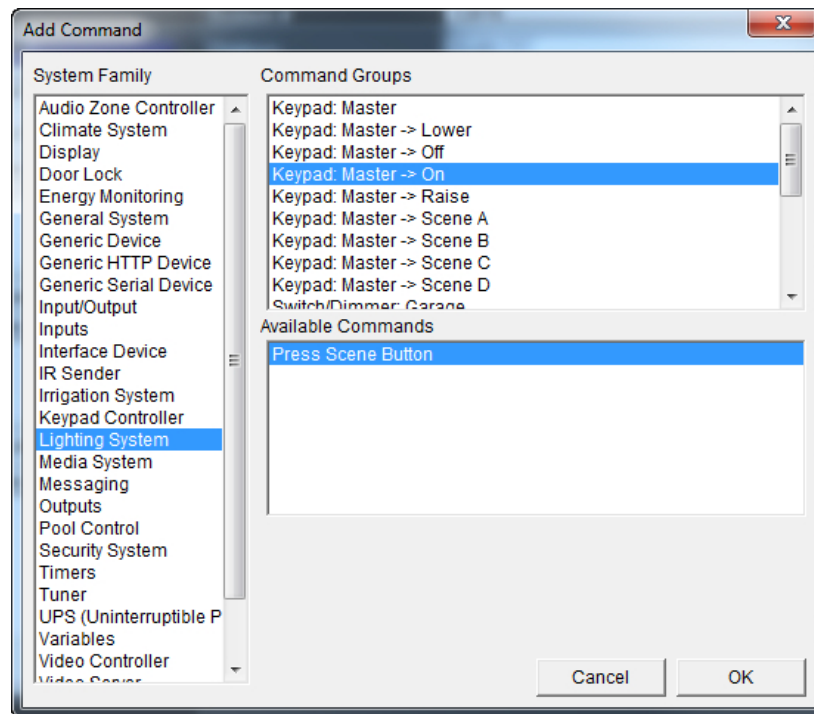

5. Click **OK** to save the command to the event map, and then close the Edit Event Map window.

The previous step is a simple example of configuring the light button. In the software there are also system commands to set the light button LED state and conditionals that can be used in the event mapper to check the LED state.

The following is an example of utilizing the Light button with the LED and conditionals to control a single load, this example requires 4 separate event maps:

- a. Event Map 1, Lights On:
 - Event: Interface Device>Client: ELAN TS7(TS10/Valet10)>Light Button Down
 - Condition: Interface Device>ELAN TS7(TS10/Valet10)> Light LED On = False
 - Commands:
 - Interface Device>Client: ELAN TS7(TS10/Valet10)> Set Light LED ON/Off = On
 - Set desired light load or scene on from Lighting System

- b. Event Map 2, Lights Off:
- Event: Interface Device>Client: ELAN TS7(TS10/Valet10)>Light Button Down
 - Condition: Interface Device>ELAN TS7(TS10/Valet10)> Light LED On = True
 - Commands:
 - Interface Device>Client: ELAN TS7(TS10/Valet10)> Set Light LED ON/Off = Off
 - Set desired light load or scene off from Lighting System
- c. Event Map 3, Lights On LED sync:
- Event: desired light load or scene turned on from Lighting System
 - Command: Interface Device>Client: ELAN TS7(TS10/Valet10)> Set Light LED ON/Off = On
- d. Event Map 3, Lights Off LED sync:
- Event: desired light load or scene turned off from Lighting System
 - Command: Interface Device>Client: ELAN TS7(TS10/Valet10)> Set Light LED ON/Off = Off

Composite Video

The TS7/TS10 can be configured to display an analog video source. If the home has more than one analog video camera installed, Event Maps can be set up to enable the display on the TS7/TS10/Valet10 to be switched between the different sources.

Note: Composite Video is only available on the TS7/TS10/VL10. The following assumes that the TS7/TS10/VL10 has been configured with the appropriate Line ID. Refer to the TS7/TS10 Video Configuration Tech Note for more information.

To configure video display on the TS7/TS10/VL10, set up a custom tab as follows:

1. On the **Video** tab in Configurator, navigate to Custom Pages in the System Node Tree.
2. Right-click Custom Tabs and select **Add New Custom Page....** *The Add New Custom Page window opens.*
3. Name the new page "Cameras", then click **OK**.

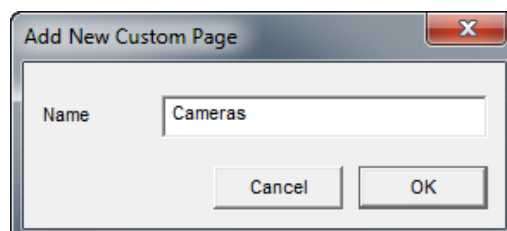

4. Under Custom Pages>Cameras in the System Node Tree, select the Large format. *The Custom Page Layout: Cameras area displays on the right.*
5. Right-click in the Page Layout area, and select **Add New Control....** *The Add New Control window opens.*

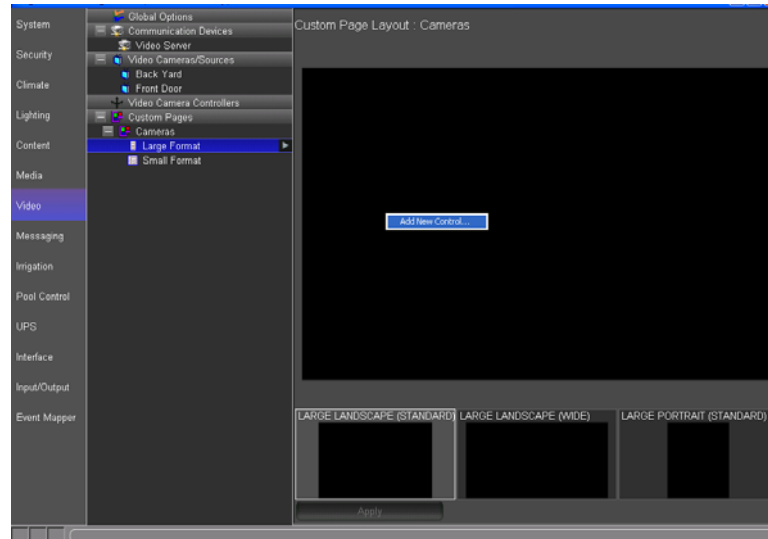

6. Select **Composite Video** from the Control Type list, and then click **OK**.

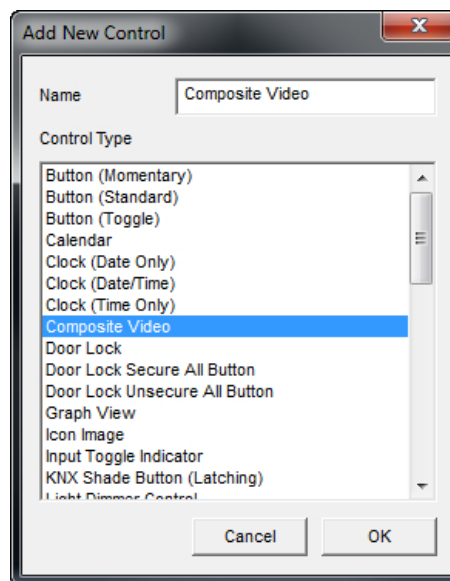

Note: A Composite Video control and Video Stream control (from an IP camera) cannot exist on the same interface. Adding one of these controls to an interface will remove the other option from the “Add New Control” dialog box.

- The Composite Video control displays on the tab layout. Resize the control to fit all the screen options.



- Select the newly added control type to bring up the Composite Video Properties window and set the **TS7/10 Line drop down** to match the Line Setting made in Interface/ELAN TS7/Advanced.

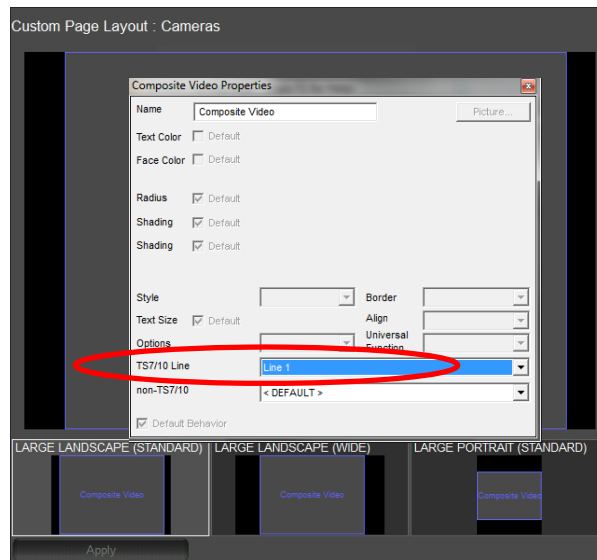

- Be sure to verify that the Line ID matches the Line ID set in the Interface>Advanced Settings properties. Note the window automatically snaps to the correct aspect ratio as soon as you resize it.

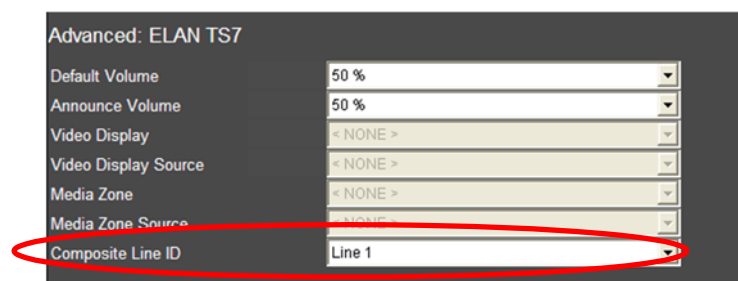

Exercise 9: Configuring the On Screen Display (OSD)

Overview The OSD, or On-Screen Display, is an interface for controlling the g! system using a television and the included IR remote control. (The OSD can also be controlled with an HR2/gHR200 Wi-Fi remote control. See Exercise 9.) The OSD is designed to control a single media zone, but basic functionality for all media zones is supported. Additionally, the OSD will provide interfaces for control and status of other sub-systems in the home.

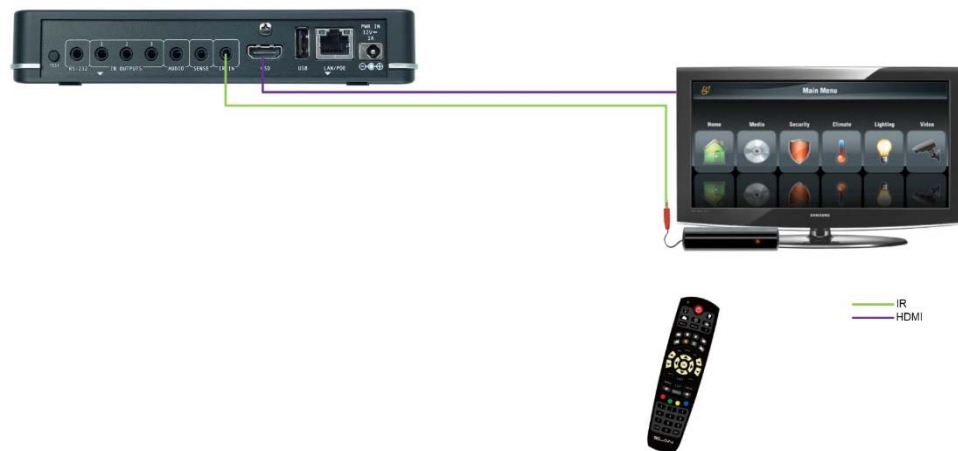

The following lists important information about the OSD that you should know:

- The OSD is provided from the HDMI output on the g1.
- The g1 will need to be setup as an Extender when used in systems that have a gSC controller set as the Master.
- The OSD is designed to provide output and control to a single display/media zone, and is not intended to be used through a Video Switch for multiple zones.
- The g1 includes a basic remote, known as the g1 remote, to provide control of sources and OSD functions through IR and Universal Functions. For more advanced features, the HR2/gHR200 WiFi remote can provide additional features alongside OSD control as explained in Exercise 9.
- The g1 remote is designed to directly drive the active source, even when the OSD is not active. This allows basic functions, such as volume, power, and source transport control to be available from the remote without activating the OSD. The g1 remote's IR input is automatically interpreted to send commands to the appropriate device. This allows generic IR input to send serial, Ethernet or IR commands, as appropriate, based on the active source, and Universal Functions.

- The OSD becomes active when the g1 receives the OSD (House button) toggle code. The g1 remote, or HR2/gHR200 Wi-Fi remote, will then change the function of some buttons in order to appropriately navigate the OSD.
 - Note that an IR receiver must be attached to the g1 to receive the IR code from the g1 remote.
 - When in OSD mode, some functions of the OSD remote or HR2/gHR200 Wi-Fi remote will change.
 - It is not possible to drive the OSD from a touchscreen or other interface, as it is intended to be controlled from the g1 remote, IR codes, or through the HR2/gHR200 Wi-Fi remote.

The OSD option is only available on the g1 controller. The g1 controller may be used as a stand-alone system controller or as an Extender to a gSC controller based system. HDMI video cable and an IR receiver must be connected to the g1 for the IR commands to be received and the signal to be displayed. Refer to the g1 Quick Install Guide (available on the ELAN dealer site) for details.

How-to

The OSD is enabled from the g1 controller. When used as an Extender to a gSC controller, the OSD should be setup on the g1 and configured on the gSC controller prior to use. These next steps will give an example of setting up the OSD on a g1.

1. In g!Tools go to My System and select the g1 as the **System Name** and click the **Configurator** button.

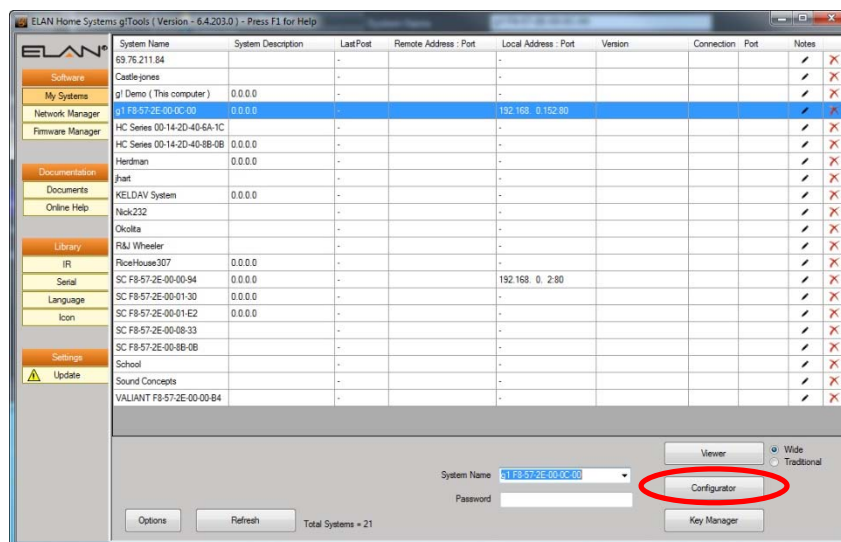

2. In the g1 configurator go to the System tab and select Basic Information.

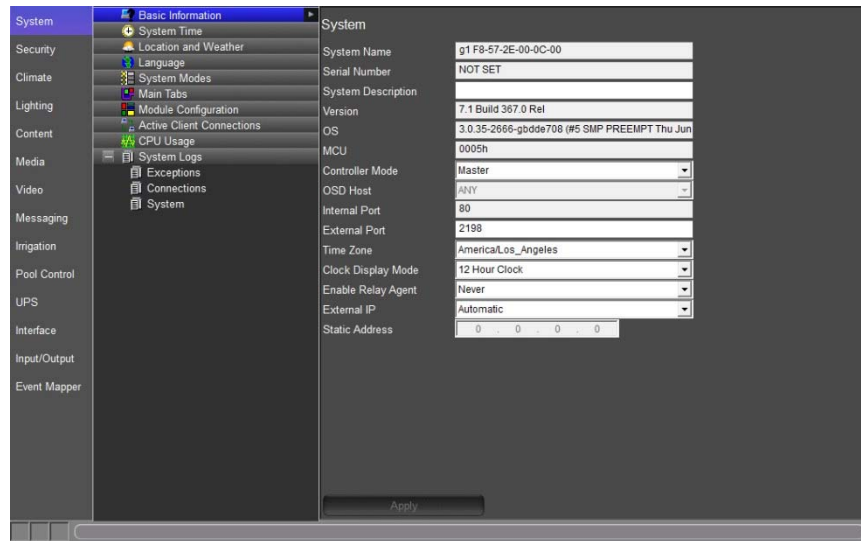

Quick Reference: g1 OSD Settings – System Tab	
Controller Mode	Operation mode of the g1: Master – the g1 is set to be a system controller Extender – the g1 is set to be an extension of a gSC controller based system or as an extension of another g1.
OSD Host	Only available in Extender mode. OSD Host is where the OSD processing is being performed. Typically this is the g1 that is providing the OSD.

3. Locate the **Controller Mode** drop-down and select **Extender**.

4. Locate the **OSD Host** drop-down and select the **appropriate g1 XX-XX-XX-XX-XX-XX**.

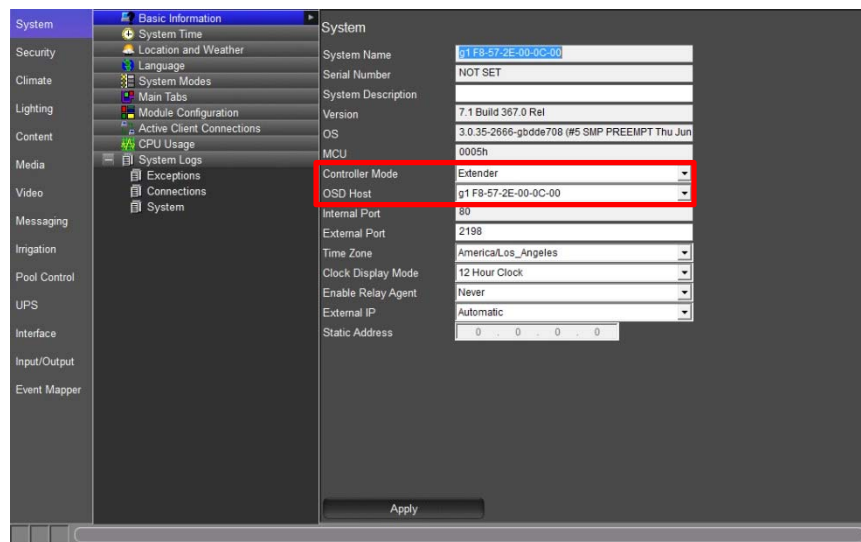

5. Select **Apply** when finished.

6. Navigate to the **Interface** Tab and select the **On Screen Display** node.

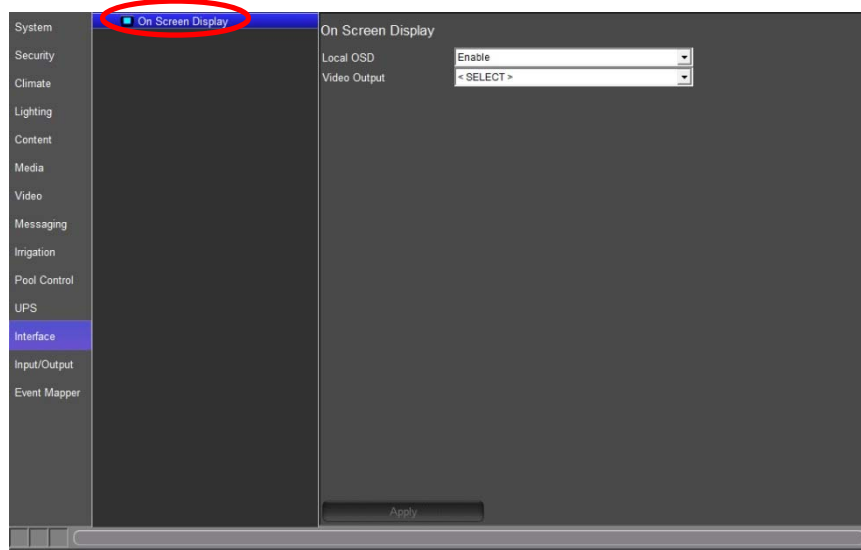

7. Verify the **Local OSD** is set to **Enable**.

Quick Reference: On Screen Display – Interface Tab	
Local OSD	Enable or disable the OSD output on the g1
Video Output	Set the video resolution for the OSD. Since the video output is HDMI this is typically negotiated by the display.

8. Ensure the g1's **Local OSD** drop-down is set to **Enable**.

Note: The Video Output drop-down sets the OSD resolution for the Video Display. In most cases this field should be left alone as the display will negotiate the video resolution over the HDMI connection.

9. Close the g1 Configurator and open the configurator for the gSC controller.

Note: If using the g1 in Controller mode do not exit the configurator. Perform the following steps in the g1 Configuration window.

10. Navigate to the Interface tab and select the **Interface Devices (OSD)** node in the System Node Tree and then select the “+” next to the **OSD** node.
 - a. Select **Advanced Settings**

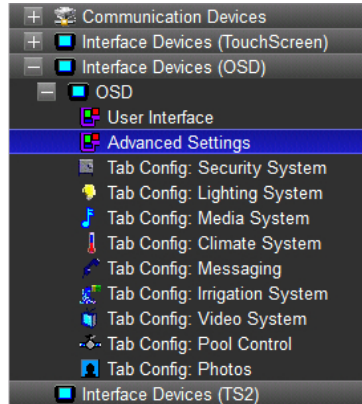

Quick Reference: OSD Advanced Settings	
Default & Announce Volume	Greyed out and not available for this interface
Video Display	The Video Display to which the g1 controller OSD is connected. This will allow the software to manage the power and inputs for the OSD.
Video Display Source	The source input the OSD is connected to on the display. This will automatically switch the display to the selected source input when the Home button is pressed on the remote control.
Media Zone	The zone controller to which the g1 controller OSD is connected. This will allow the software to manage the power and inputs for the OSD. Typically used when connecting the OSD output to an AVR.
Media Zone Source	The source input the OSD output is connected to on the zone controller. This will automatically switch the zone controller to the selected source input when the Home button is pressed on the remote control. Typically used when the OSD output is connected to a source input of an AVR.
Overscan Left, Right, Top, Bottom Adjustments	Adjustments so that an image fits properly on a video display.

- b. In the Video Display drop-down select **the display the OSD will be shown on**. This exercise will use **Bedroom LG TV**.
- c. In the Video Display Source select **the source input the OSD is connected to**. This exercise will use **(INPUT HDMI 2)**. When finished your screen should look similar to the below image.

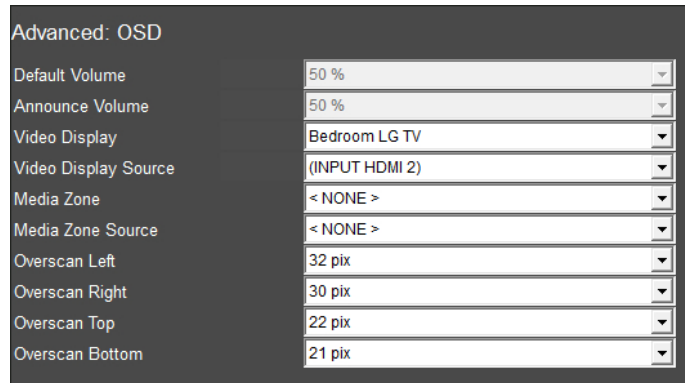

Note: If using an Audio/Video receiver in a zone where the OSD will be displayed the Media Zone and Media Zone Source fields will also need to be set. When connecting the OSD to an AVR the AVR's built-in sources, such as the internal Tuner or streaming services, are not available while the OSD is active.

- d. Select **Apply** when finished.
- e. Navigate to the **Tab Config: Media System**.

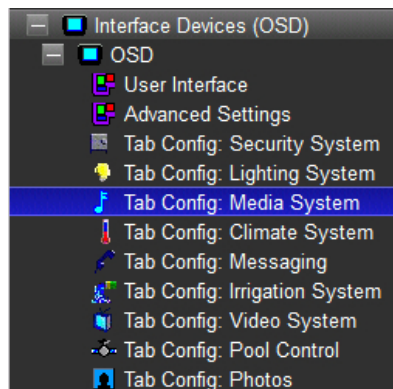

- f. In the Available Tabs column select the **zones that you wish to view** from the OSD interface. **Press and hold Ctrl and click on each** desired zone.

- g. Select **Add Tab >>** to add the zones to the Visible Tabs column and select **Apply**. This exercise will use Living Room and Bedroom media zones.

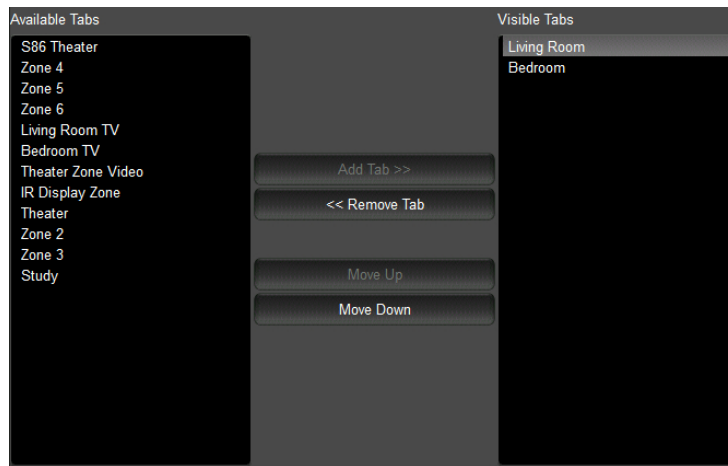

Note: The g! OSD is designed to control a single media zone. Though multiple media zones may be viewed from the g! OSD only 1 media zone may be controlled by the IR remote included with the g1. If control of multiple media zones from the g! OSD is desired than additional g1 units will need to be added. Each g1 unit adds control of an additional media zone.

- h. Select the **Default Tab drop-down** and choose the **desired zone** OSD will control. This exercise will use the Bedroom media zone.

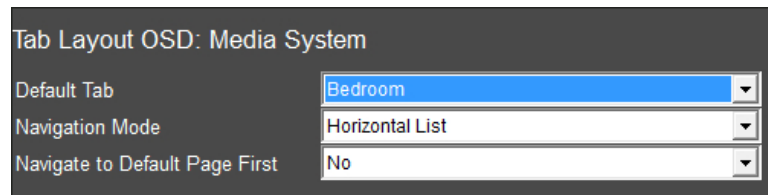

Note: Assigning the media zone to the Default Tab enables the g! OSD for that zone. This setting also allows the g1 IR Remote Control to operate the sources in the selected Media Zone.

- i. Select **Apply** when finished.

11. Navigate to the **Input/Output Tab**.

- a. Select the **IR Receivers** in the System Node Tree.



- b. Select the **Arrow Box** and select **Add New IR Receiver**.
- c. In the Add New IR Receiver window enter the **desired name for the g1 unit** providing the OSD in the **Name field**. In projects containing multiple g1 units use names that allow you to easily identify each g1 unit.
- d. In the **Device Type** section select **g1 IR Receiver**.

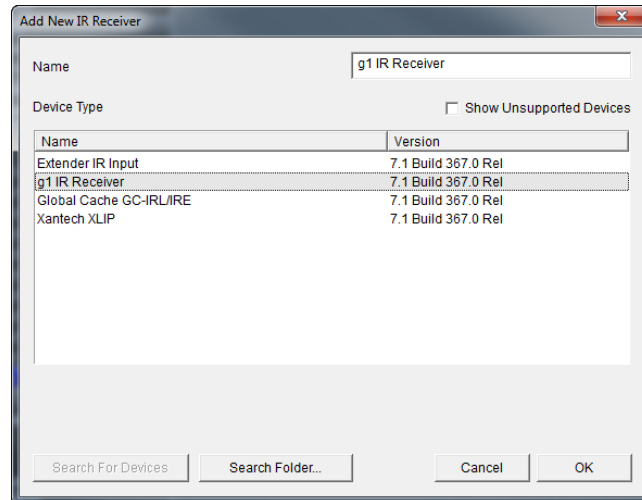

- e. When finished select **OK**.

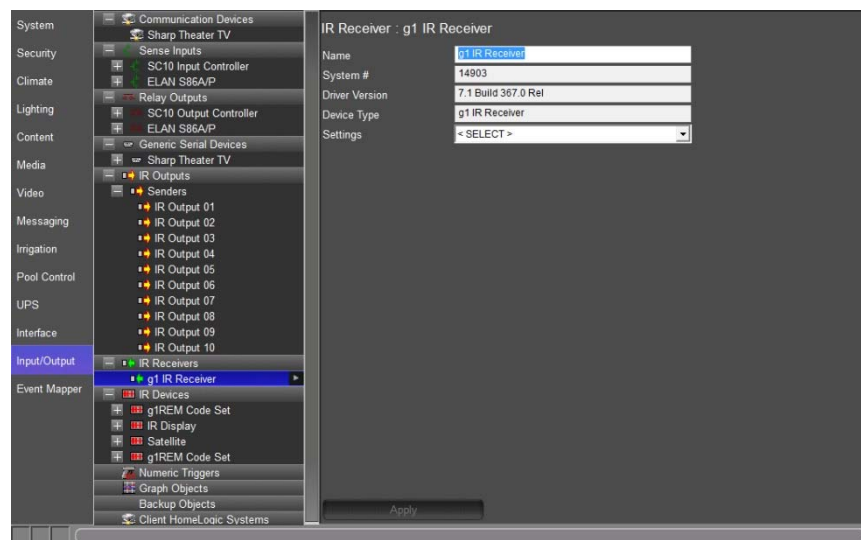

- f. In the Settings drop-down select **the g1** providing the OSD.

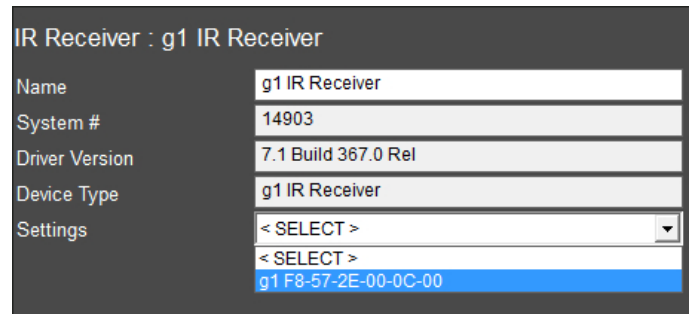

- g. Select **Apply** when finished.

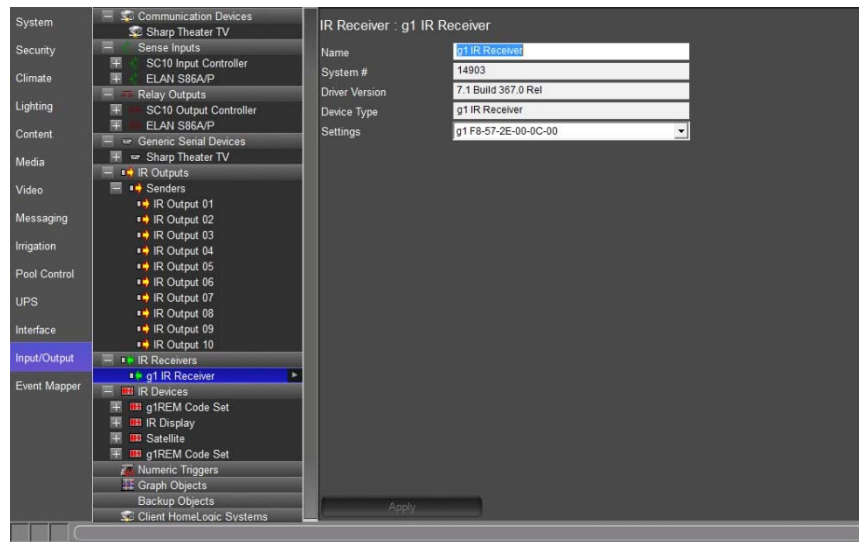

12. Navigate to the **Media Tab**.

- a. Select the **media zone** where the **OSD will be displayed** from the Zone Controllers System Node Tree. This is the Default Media Zone set previously. For this exercise we will **use the Bedroom zone**.

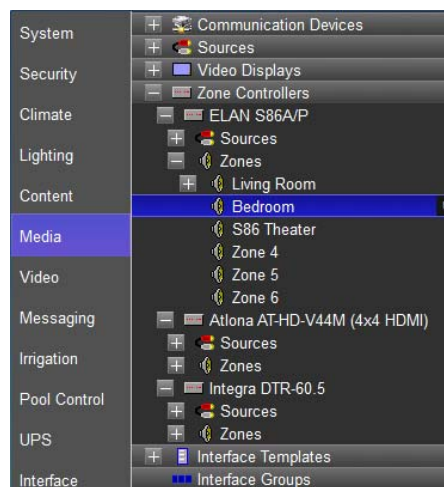

- b. In the Properties Pane for the Bedroom zone select the **g1 IR Receiver** from the **Universal Receiver** drop-down.

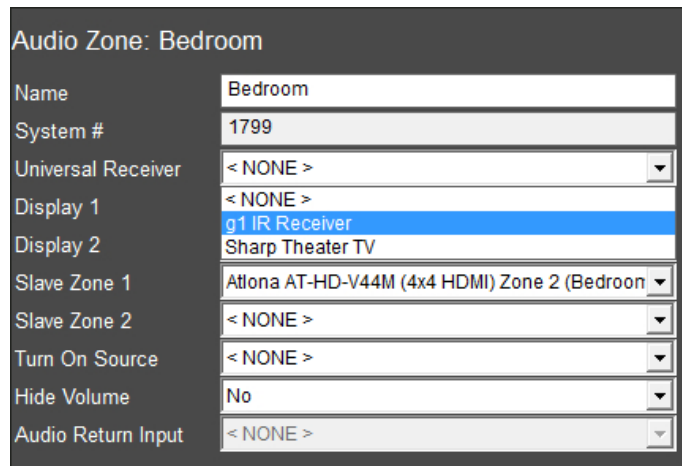

- c. Select Apply when finished.

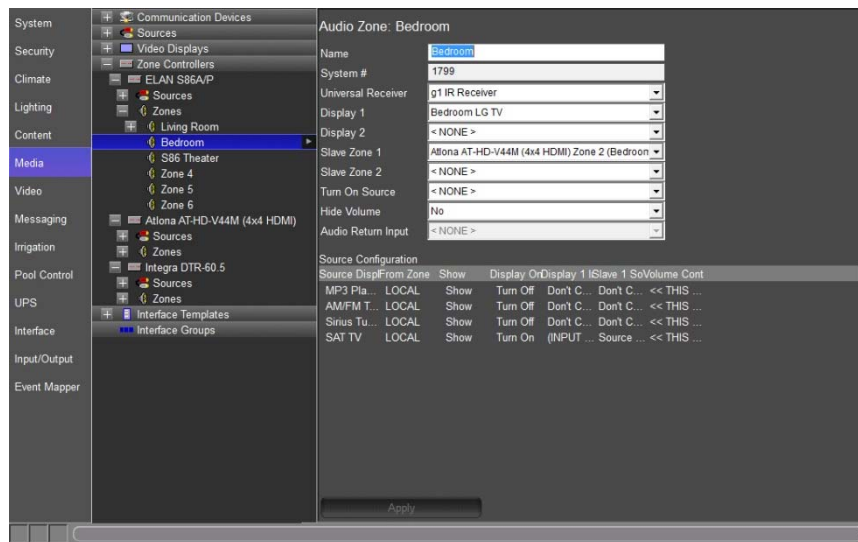

13. **Tab Config:** The tab config settings can be used to show or hide various systems in the OSD. These settings can also change the order in which the subsystems appear. Below is an overview of each system and its functionality on the OSD.

- **Security** – The Security OSD is built in and allows for multiple partition selection. For each partition the OSD will show the security panel, zone, and fault status and allow for arming/disarming the system, and locking/unlocking wireless door locks.

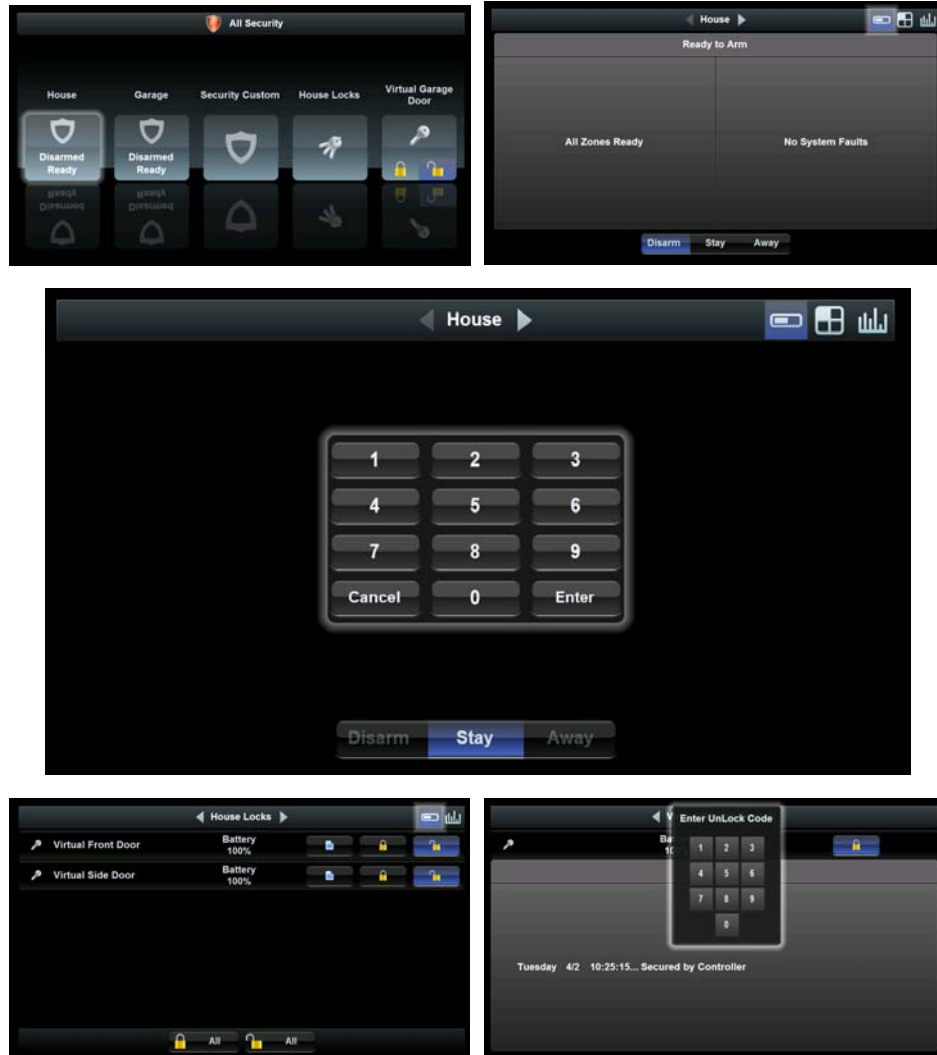

Remote Function: For the Security section of the OSD, the standard cursor controls are used for navigation; when arming/disarming or locking/unlocking, the number keys of the remote are used for PIN entry. If a default media zone is active, hard buttons like Volume will still pass to the default media zone.

- **Climate** – The Climate OSD interface is built in and includes an all zones selection page with status overview and each thermostat page includes status and settings for heat/cool set points, system and fan mode.

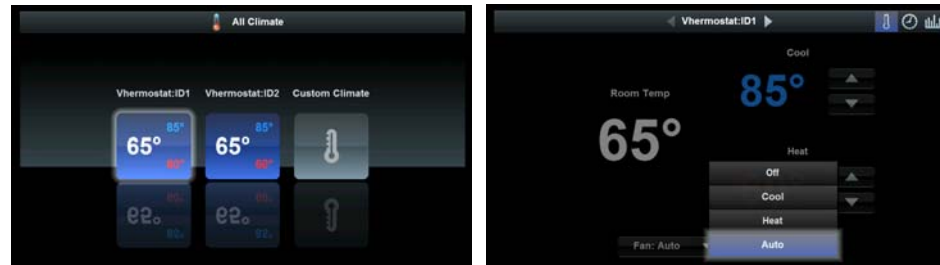

Remote Function: For the Climate section of the OSD, the standard cursor controls are for navigation. If a default media zone is active, hard buttons like Volume will still pass to the default media zone.

- **Lighting** – The Lighting OSD interface is uses preconfigured Keypad Interfaces and Custom Pages.

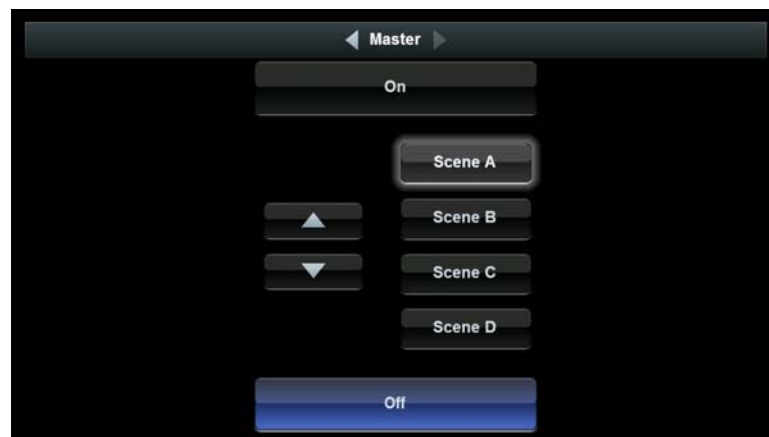

Remote Function: For the Lighting section of the OSD, the standard cursor controls are used for navigation. Select a specific light by highlighting it with the cursor to make it active. When selected, the arrow keys can be used to raise/lower lights. For toggle controls, the OK button will toggle between On and Off states. If the default media zone is active, hard buttons will still pass to the default media zone.

- **Media** – The OSD interface for Media provides an overview page for all Media zones but is designed to drive media in the Default Media Zone.

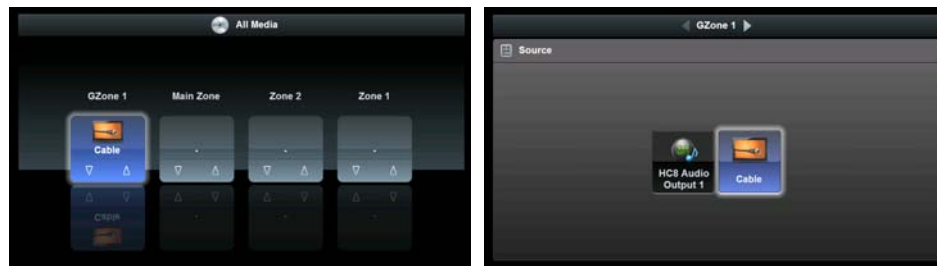

- Default Media Zone – Certain sources can display an interface to the OSD, such as the Internal Audio Player, and can be controlled from the OSD regardless of zone. Other sources do not provide an interface to the OSD as they are best driven through their own video output (such as the majority of sources using Custom Interfaces, like a Cable Box). Sources without an OSD interface will automatically deactivate the OSD and switch to the configured display settings in the Default Zone. When this occurs, the sources own video output (if available) is displayed, and the remote hard buttons use Universal Functions to send the correct commands to the active source.
- Set a Default Media Zone – On the Tab Config for Media there is a **Default Tab** selection. The selection defines the zone that the OSD interface is assigned to. When this selection is made, the OSD IR remote provides power, source selection, and volume control for that zone, even when the OSD is inactive. Additionally, the remote provides universal control for the active source in this zone.

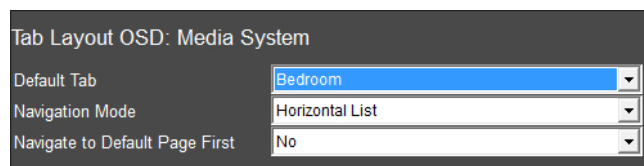

Remote Function with OSD Active: For the Media section of the OSD, the standard cursor controls are used for navigation and selection of basic zone and source selections. Except for the Play button, which is required to play a selection. If the default media zone is active, hard buttons like transport controls still pass to the default media zone.

Remote Functions with OSD Inactive: When the OSD is toggled off, the g! remote hard buttons can still be used to control the Default Media Zone. Buttons including Power, Mute, Volume, and transport controls (Play, Pause, Prev, Next) will still control the Default Zone and current active source without activating the OSD.

- IR Library Source and Custom Source types in the Media tab have additional options available for how they will behave when selected in the OSD interface. Please review the below and set appropriately.

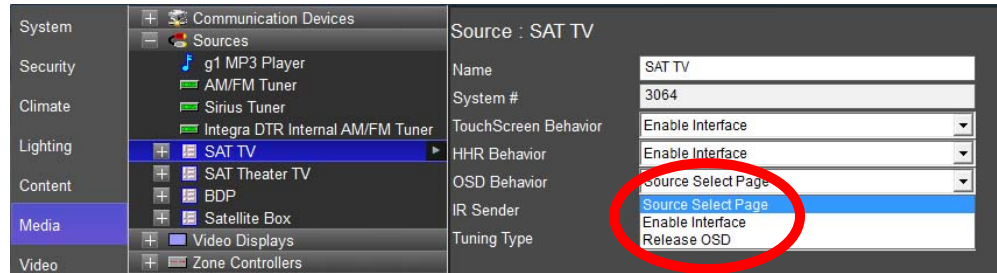

Quick Reference: OSD Behavior – Media Tab	
Source Select Page	After the Source is selected the OSD will remain on the Source Selection page.
Enable Interface	After the Source is selected the OSD will display the source interface. I.E. when tuner is selected the Tuner Interface is shown on the OSD, when Sonos is selected the Sonos Interface is shown on the OSD, etc.
Release OSD	After the Source is selected the OSD will be deactivated.

- **Video** – The OSD video interface provides a video overview page for selecting and viewing individual cameras.

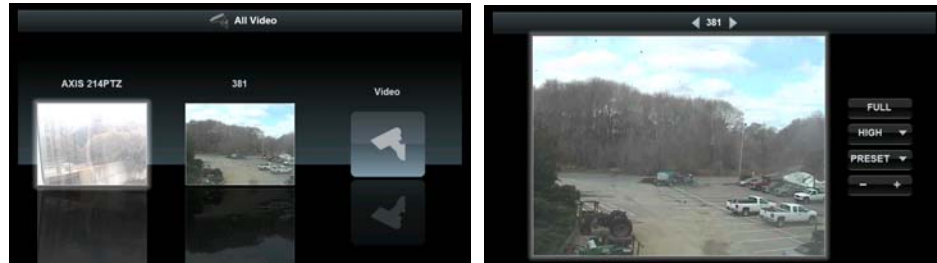

Remote Function: For the Video section of the OSD, the standard cursor controls are used for navigation of video feeds on the Overview screen. With a video feed highlighted using the cursor controls, press **OK** on the remote to make that feed full screen. In Full Screen mode, the arrow keys can be used on compatible cameras to pan/tilt the video feed, and the Page Up/Page Down buttons can be used to zoom. You can also select existing preset Pan/Tilt/Zoom positions by pressing number keys 1–8. If a default media zone is active, hard buttons like Volume will still pass to the default media zone.

- **Irrigation** – There is no OSD interface or control for the Irrigation App.
- **Pool** - There is no OSD interface or control for the Pool App.
- **Photos** – The OSD photos browser will provide folder browsing for the configured photos library. The OSD remote can be used to navigate the photos, or the selected folder can be set into random slideshow. Use the arrow buttons to navigate the photos. Press **OK** to present the selected image full size; press **OK** with the image full size to start the slideshow.

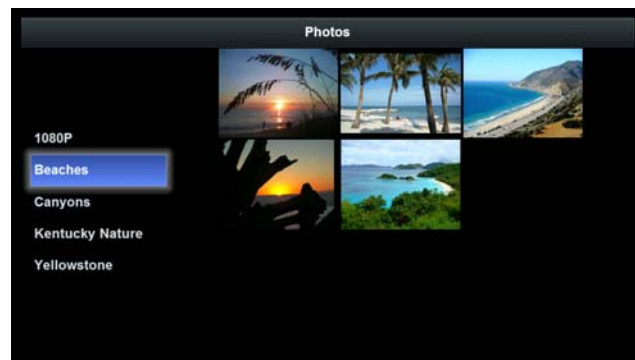

Remote Function: For the Photos section of the OSD, the standard cursor controls are used to navigate the photos, or the selected folder can be set into random slideshow. Use the arrow buttons to navigate the photos. Press **OK** to present the selected image full size; press **OK** with the image full screen to start the slideshow in that folder. If a default media zone is active, hard buttons like Volume will still pass to the default media zone.

- **Other g1 remote functions** – The following functions are generally true, with some exceptions when OSD is active in certain partitions.
 - **OSD (Home) toggle:** Toggles OSD
 - **Power:** Toggles Power on & off for Default Media Zone. Press and hold to turn all media zones off.
 - **(Lights Off):** Set up in the g! Configurator to turn a lighting load, or lighting scene, off.
 - **(Lights On):** Set up in the g! Configurator to turn a lighting load, or lighting scene, on.
 - **Sub-System Direct Access Buttons:** Set up in the g! Configurator to access climate, media, or whatever makes your client happy. These buttons are setup in the Event Mapper tab. The g1 remote buttons are located in the System Family Input/Output, Event Group g1REM Code Set: XXXX, and the Available Events are IR Code Begin Receive and IR Code End Receive.

Note: An Event can begin with **g1REM Code Set: XXXX>IR Code Begin Receive or IR Code End Receive**. The Commands sent when the IR code is received can include a specific action or multiple actions.

- **Menu:** If OSD is active, returns to main page of OSD.
- **Last:** If OSD is active, goes back one page.



Exercise 10: Adding and Configuring the HR2/gHR200 Wi-Fi™ Remote Control

Overview The HR2/gHR200 Handheld Remote (HHR) Control is a slim, portable device that provides an interface to the g! system through a familiar and convenient remote control form factor. The HR2/gHR200 combines a customizable LCD touch screen with an array of remote control style hard buttons. Through instant-on Wi-Fi, the HR2/gHR200 can provide control and feedback of Serial, Ethernet, and IR subsystems attached to a compatible g! System Controller. The HR2/gHR200 is designed to control a single media zone, but basic functionality for all media zones is supported. Additionally, the HR2/gHR200 provides interfaces for control and status of other subsystems in the home.

The supported 2-way features include:

- Media zone and source control
- Hard buttons to drive current source
- On-Screen Display (OSD) functions
- System mode control and optional weather information
- Basic security and climate feedback and control
- Customizable lighting control
- Special functions in certain areas
- IR Blaster: The HR2/gHR200 includes an IR blaster for providing power control of a video display where it is not possible to run an IR emitter or another type of control method.

The following controls are supported using the touch screen interface:

- Audio button, keypad, mode control, and sound adjustment
- Channel favorite button

Once the Wi-Fi network information is set up, the HR2/gHR200 remote is automatically added to the Configurator and connected to the controller. The HR2/gHR200 remote needs to be configured once prior to use.

The HR2/gHR200 remote option is available only on the gSC and HC-Series controllers and is not available on a HomeBrick or MultiBrick.

Note: Refer to the HR2/gHR200 Integration Note (available at the ELAN dealer site) for details.

HHR Layout & Features

The HR2/gHR200 features a customizable touch screen, and an array of hard buttons to provide control of various subsystems attached to a compatible g! system controller.



The following lists some basic operational notes on the HR2:

Power Button: The power button is configurable; refer to the *HR2 Interface Device* table below.
Press and hold the **Power** button to send an All Zones Off to all media zones.



Touch screen: The information in this area may change, but in general all but the thin line at the bottom of the touchscreen can be pressed.

Note: From the main menu, if you press and hold a button such as Climate (🌡️) on the touchscreen, the touch screen displays a new page which lists all the zone selections from that subsystem that are available on the HR2. If you single tap 🌡️ button, the last accessed selection is displayed.



Button Display: The thin line at the bottom of the touchscreen is actually three buttons that are contextual and become accessible when you press the corresponding arrow (▲) button below the touchscreen. For example, Random was toggled on by pressing the right-most arrow (▲) button.

Arrow Buttons: The two rows of buttons (the first row with the three arrow (▲) buttons, and the second row with Now Playing (▶), Media, and g! buttons) will always affect the HR2 Touchscreen, unless you are in OSD mode.

Press and hold the **Media** button to access the settings page for the current media zone. In OSD mode, the Now Playing (▶), Media, and g! buttons will affect the OSD.

The second row of buttons on the gHR200 features a ROOMS and a House button. Rooms will display all media zones assigned to the gHR200. The House button will enable the OSD when assigned to the media zone the gHR200 is controlling.

All hard buttons below the silver line will, in general, send commands to the current source or active media zone, except when the HR2 is in OSD mode. In that case, the buttons are either disabled or provide the same functions as the g! remote. See OSD Exercise 7 for more details.



HR2



gHR200



How-to

If you have an HR2 or gHR200 remote, follow along with the instructor. If you do not have an HR2 or gHR200 remote, refer to the Integration Note. The HR2 and gHR200 will now be referred to as the HHR (Handheld Remote) for easy reference.

1. Verify the core module version for the HHR radio as follows:
 - a. Navigate to the **System** tab in the configurator
 - b. Select the **Basic System** node in the System Node Tree
 - c. Verify that the core module **Version** is 5.2 or later for HR2 and 7.1 or later for gHR200.
2. Add the HHR remote as a new communication device to the Configurator.
 - a. Navigate to the **Interface** tab.
 - b. In the System Node Tree, right-click **Communication Devices** and click **Add New Communication Device**. *The Add New Communication Device window opens.*
 - c. Do the following:
 - Enter the **Device Name: HHR**
 - Set the **Communication Type** to **ELAN HHR Controller**
 - Set the **Hardware Type** to **Ethernet**
 - Click **OK**.

Note: Only one Communication device is required for any number of HHRs.

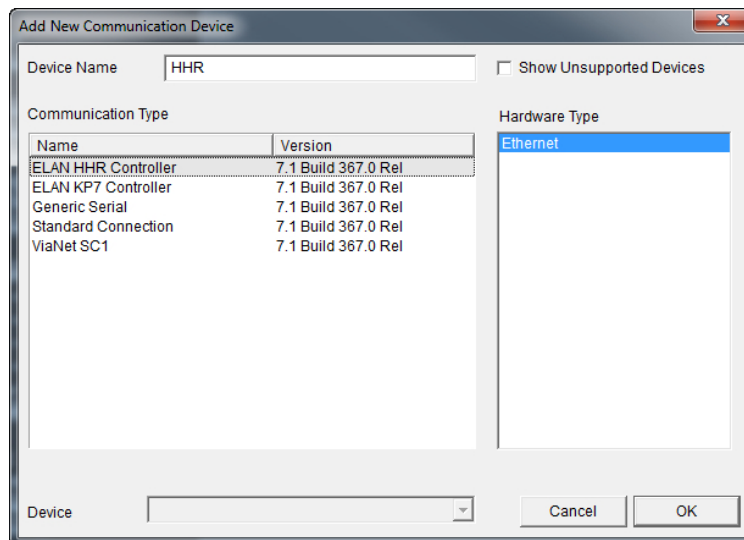

3. Remove the end cap on the HHR.



4. Connect the HHR remote to your PC with the included USB-to-mini USB cable and perform these steps:
 - a. Power on the HHR remote until it boots up with the **Enter Password** screen.
 - b. On the remote, press the numbers **3526** and press **ENTER**. *The Remote screen should state "Correct" and switch to USB active.*
 - c. If a window pops up reporting disk or file errors, click **Fix** or **Run Scan** button, then close the window after it runs.

5. Right-click the **HHR Communication Device** in the System Node Tree and select **Configure attached HHR** from the menu. *The Configure HHR dialog box opens.*

6. Configure the dialog box as follows:
 - a. Type the IP address for the HHR (outside of the network DHCP range) in the **HHR IP** field.

Note: Get the IP address from your network administrator, if you do not know it.

- b. Click **Load Controller Settings** to automatically set the **Netmask**, **Gateway**, and **Controller IP** fields.

Note: Controller must have static IP for this function.

- c. Type the SSID that the HHR remote is connecting to in the **SSID** field.
 - d. Select the encryption type and enter the wireless password in the **Passphrase** field.
 - e. Click **Save Configuration** to add the configuration information to the remote.
 - f. When you get the notification that it is safe to disconnect the USB, click **OK**.

- Remove the USB cable. *The remote will reboot and then display “Configuring Radio.” This may take a minute or two to complete. It will then connect to the access point and finally the system controller. Once connected to the system controller, it will automatically populate an entry under the **Interface** tab, **Interface Devices** in the System Node Tree.*

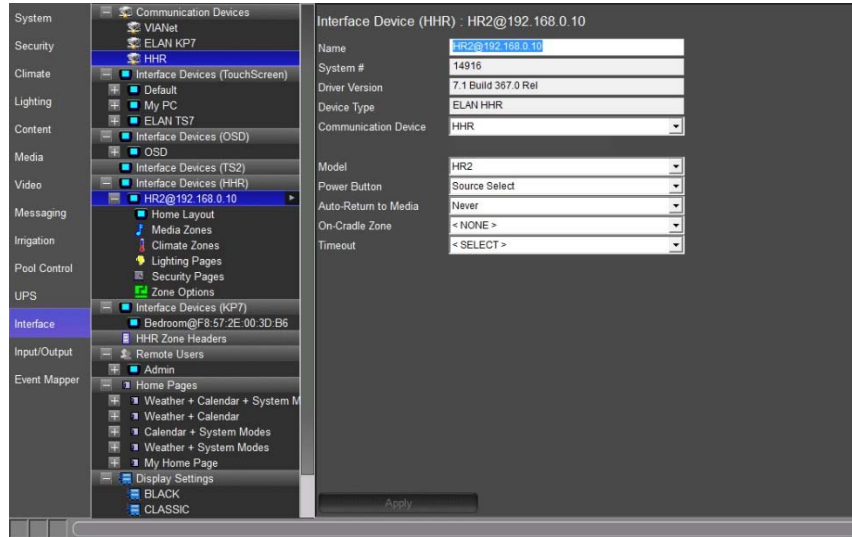

Quick Reference: HHR Interface Device	
Name	Editable field to name the device.
System #	System-assigned number. Cannot be changed.
Device Type	Pre-filled with device type selected when adding this device. Cannot be changed.
Communication Device	Select the communication device for this interface.
Model	Drop-down used to select remote being used, HR2 or gHR200
Power Button	<p>Source Select – Press On to display the source select page for the selected zone. If the remote is On, press to turn Off.</p> <p>Toggle – Changes a zone to On if the previous selection was Off or vice-versa. If the remote is Off, when it is turned On, it returns to the last active source.</p> <p>Optionally, you can select a Turn-On Source from the Configurator Media tab on the Audio Zone set up page. This will force the zone to always turn on to that source when the power is toggled on.</p>
Auto-Return to Media	Defines how long the remote interface stays at a different subsystem before it returns to the default media zone.

	Settings are: <i>Never, 10 or 30 secs, 1 or 2 mins</i>
On-Cradle Zone	Optionally, you can set a media zone to which the HHR remote returns when it is placed on the cradle.
Timeout	Determines how long the remote screen displays before going dark. The settings are: <i>10, 15, 20, 30, 45, 60 secs</i>

8. Set up the **Interface Device** fields as follows:
 - a. Change the **Name** field in the properties window to the location where the remote is installed, such as "Living Room@xxx.xxx.xxx.xxx".
This is critical if you have multiple remotes at different locations.

Note: Remember to include the IP address of the HHR in the Name for easy identification. Press the Menu and Info buttons on the HHR remote at the same time, and the remote screen displays the name that you set.

- b. Verify that the **System #**, **Device Type**, and **Communication Device** are automatically detected.
- c. Set the **Power Button** field to one of the following settings:
 - **Source Select**
 - **Toggle**
- d. Set the **Auto-Return to Media** field to one of the following settings:
 - **Never**
 - **10 or 30 secs**
 - **1 or 2 mins**
- e. Set the **On-Cradle Zone** field to a zone.

Note: The On-Cradle Zone cannot be set until media zones have been assigned to the HHR.

- f. Set the **Timeout** field to a time setting.
- g. Click **Apply**.

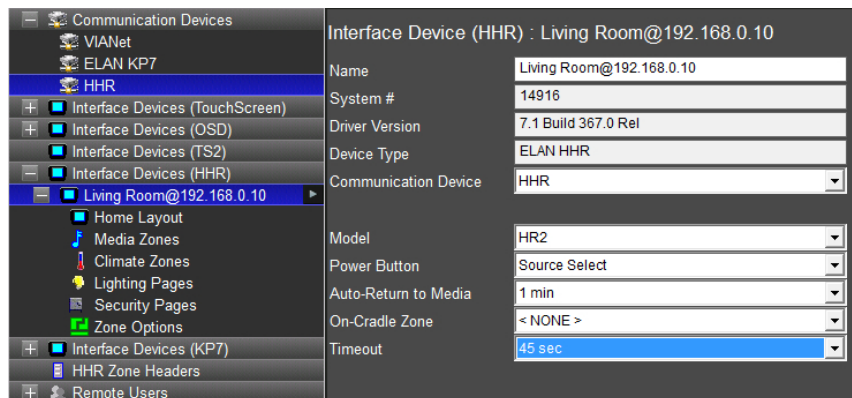

9. Click the “+” next to the **Living Room Remote** entry under **Interface Devices (HHR)** to view the HHR configuration setting options.

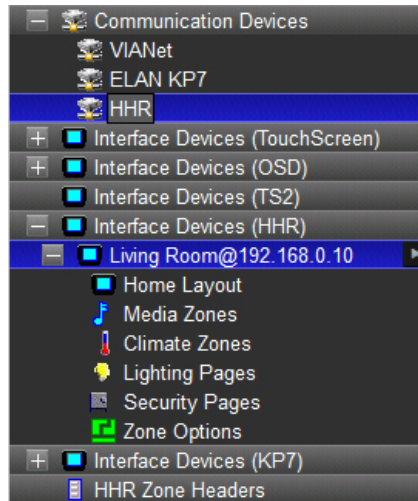

10. Configure the display screen for the remote by selecting to hide or display the tabs in each zone previously set up in the Configurator and click **Apply** for each configuration.

- **Home Layout** – configure the Home interface to provide the status and control of system modes or display the weather conditions and forecast information.

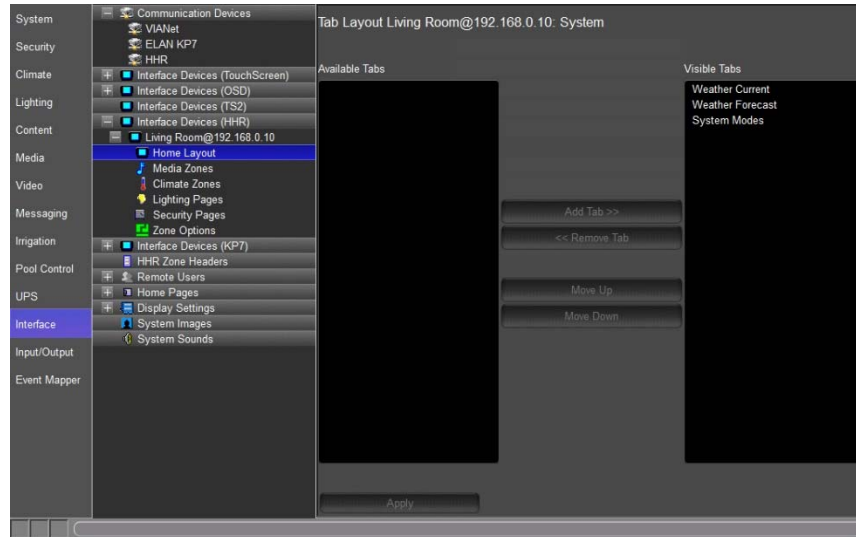

- **Media Zones** – configure the system to display one or more media zones.

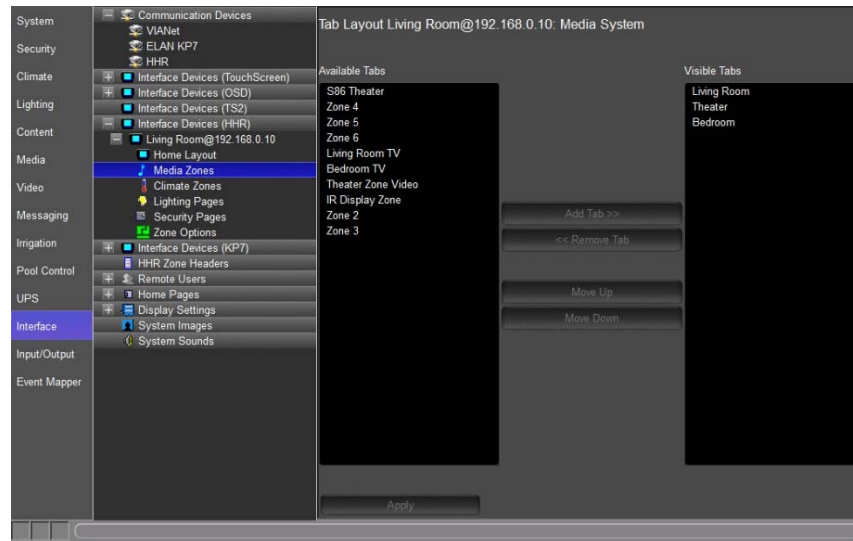

Any sources using custom interfaces that will be displayed on the HHR, must have interfaces configured on the HHR resolution for that interface on the **Media** tab. When creating the interface for the HHR, notice that many standard controls (arrow keys, channels, and so forth) are shown already as physical buttons on the HHR and will be mapped automatically to send the appropriate commands. Therefore, the only controls that need be shown in the HHR resolution are for buttons or controls unavailable from the HHR hard buttons. You may also customize which command is sent when a specific button is pressed. See the next section, “Customize HHR Button Mapping.”

Note: TV Channel Favorites use the same special button control as the TS2. For more information, see the TS2 exercise in this lesson.

Customize HHR Button Mapping

Any of the hard buttons below the silver line on the HHR remote can be customized to send a different command than what is shown on the button. This section explains how to reprogram those HHR buttons.

For Example: You can program a button such as the **Page Up and Down** buttons on the HHR remote and customize them to access the **Channel Up and Down** commands of your satellite box.

1. Navigate to the **Media** tab on the Configurator.
2. Under **Sources**, click “+” to expand the list.
 - a. Select the source device that you want to customize, such as SAT TV.
 - b. Select **SAT TV** to display the button settings.
 - c. Locate **Page Up** under the Incoming Code column.
 - d. Right-click **Default** under the Behavior column and change to **Override**.

Source : SAT TV

Name: SAT TV
System #: 3064
TouchScreen Behavior: Enable Interface
HHR Behavior: Enable Interface
OSD Behavior: Source Select Page
IR Sender: IR Output 01
Tuning Type: Satellite (Type 1)

Incoming Button	Behavior	Output Device	Output Code/Command
Mute Toggle	Default		
Power Cycle	Read Only		
Clear	Default	SAT TV	DIGIT SEPARATOR
Exit	Default	SAT TV	EXIT
Live TV	Default		
Info	Default	SAT TV	INFO
Page Up	Override	SAT TV	MENU
Page Down	Default		
List	Default	SAT TV	MENU DVR
Random	Default		
Rewind	Default	SAT TV	REVERSE
Fast Forward	Default	SAT TV	FORWARD
Pause	Default	SAT TV	PAUSE
Skip Back	Default	SAT TV	REPLAY
Skip Forward	Default		

Apply

- e. Select the desired custom output device from the Output column. For this exercise we are using **SAT TV**.

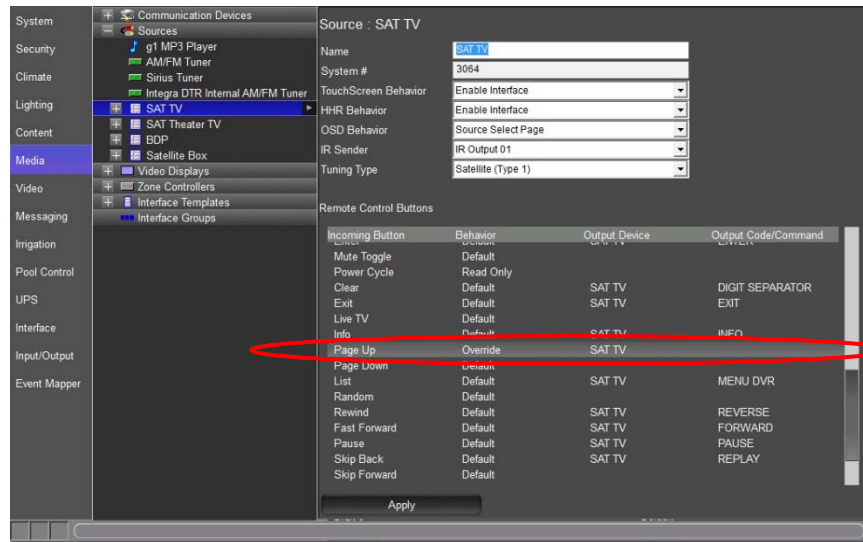

- f. Select the desired output code from the Output Code column. When using DirecTV the Channel Up and Down commands will page up and down when the Guide is activated.

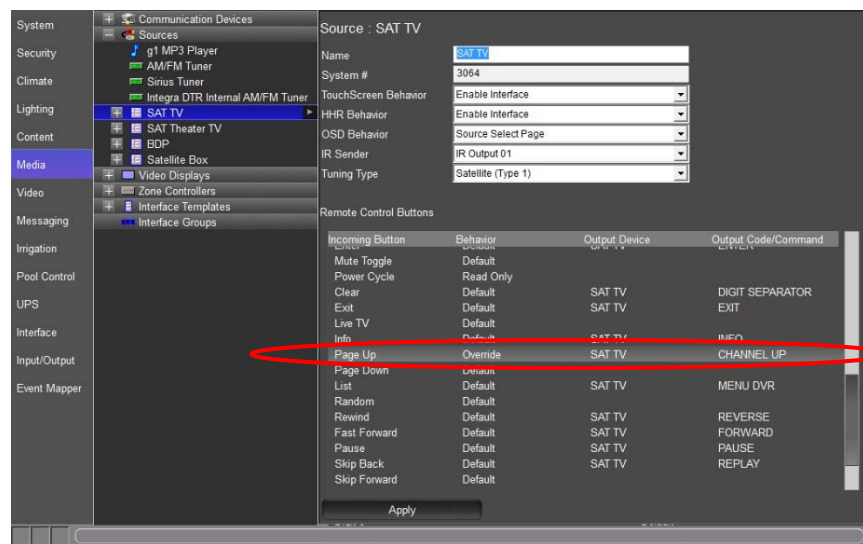

3. Click **Apply**.
4. Repeat step 1 thru 3 for **Page Down**.

Note: Custom mapping is global for the source and will affect all g! interfaces such as touchscreens and PC Viewer.

- IR Library Source and Custom Source types in the Media tab have additional options available for how they will behave when selected by the HR2/gHR200. These options are set in the HHR Behavior drop-down menu. Please review the below and set appropriately.

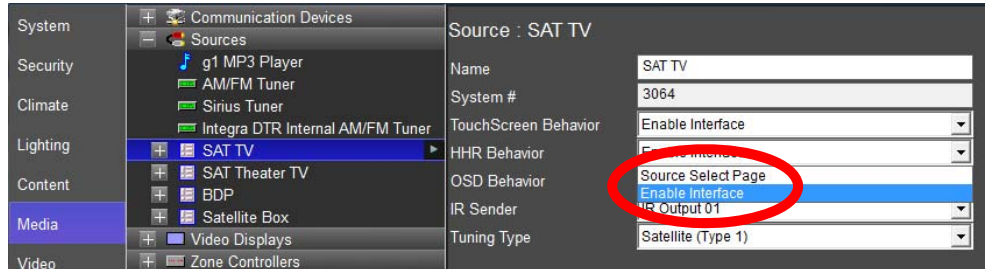

Quick Reference: HHR Behavior – Media Tab	
Source Select Page	After the Source is selected the HHR will remain on the Source Selection page.
Enable Interface	After the Source is selected the HHR will display the source interface setup for the HHR interface.

- **Climate Zone** – Configure the system to display one or more climate zones. The HHR remote provides heat or cooling mode and fan control, and includes adjustments to temperature settings.

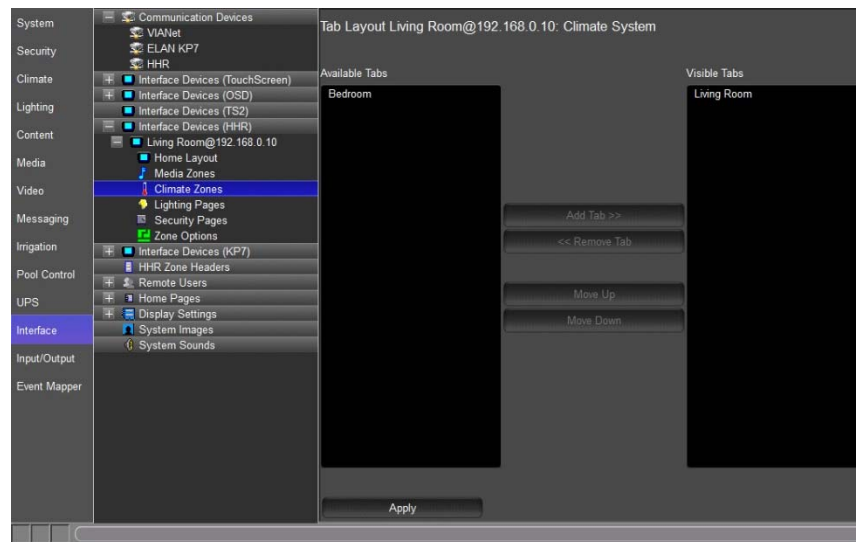

- **Lighting Pages** – Configure the system to display one or more custom lighting keypads. The HHR remote touchscreen provides 2-way control of your scenes and lighting devices.

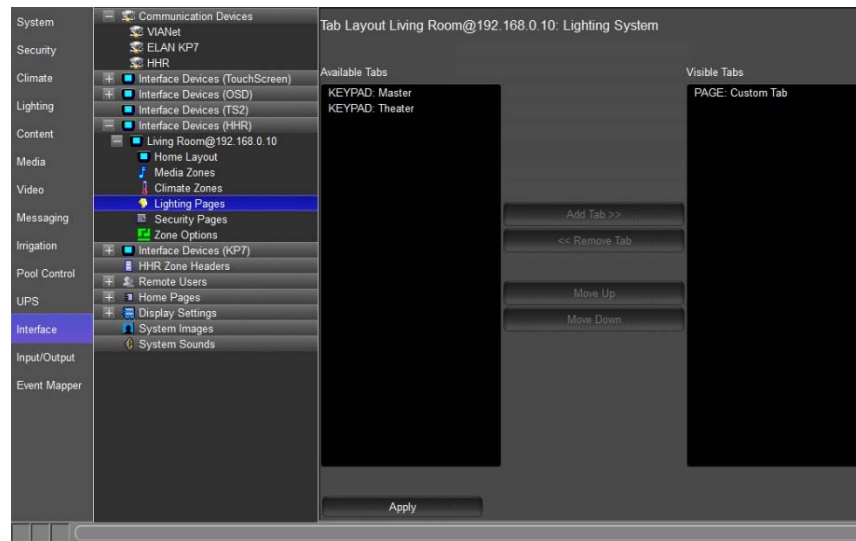

Note: It is recommended you create custom Keypads for the HHR's screen for best results. The TS2 Keypad Templates are a good starting point, for more details see the TS2 Exercise in this Chapter.

- **Security Pages** – Configure the system to display one or more partitions. The HHR displays a keypad in the touchscreen that you can use to arm or disarm a partition.

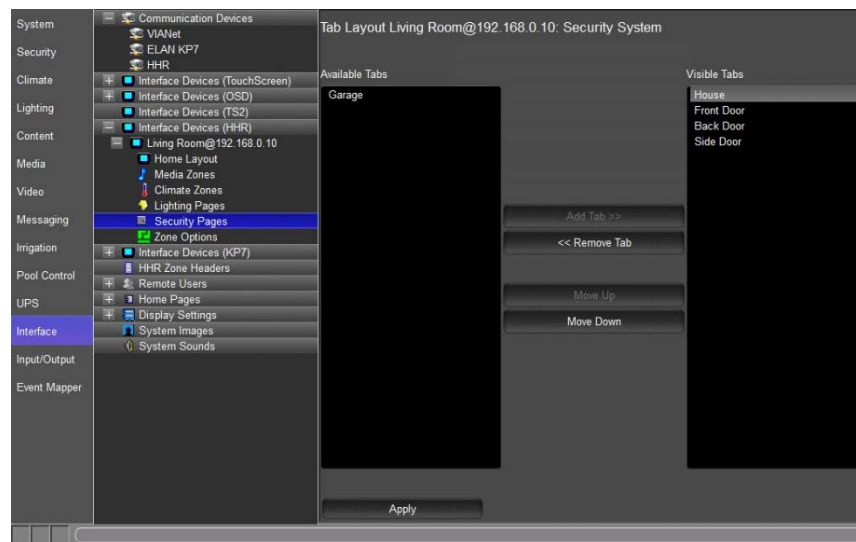

Note: You can select Zone Options to map Media zones and set your default lighting keypad, default thermostat, and default security zone. See online help for instructions.

Using the HHR to Control the OSD

The HHR provides control of the g System with the On Screen Display by accessing a special OSD mode. In OSD mode, the touchscreen of the HHR will not show the normal interface, and the behavior of the HHR hard buttons is changed. To enable OSD mode on the HHR, the OSD must have a default zone configured.

1. Navigate to the **Interface** tab on the Configurator.
 - a. Select **Interface Devices (OSD)**
 - b. Click “+” to the left of **OSD** to expand the list.
 - c. Select **Tab Config: Media Systems**.
 - d. From the **Default Tab** drop-down box, select the zone to which the OSD interface is assigned.
 - e. Click **Apply**.

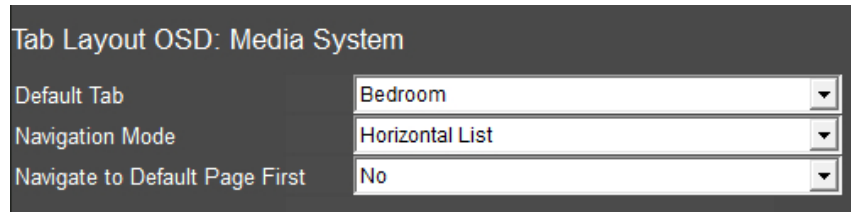

Tab Layout OSD: Media System	
Default Tab	Bedroom
Navigation Mode	Horizontal List
Navigate to Default Page First	No

2. Under **Interface Devices (HHR)**, click “+” to expand the list.
 - a. Select **HHR Remote**.
 - b. Click “+” to expand the list and select **Media Zones**.
 - c. From the **Available Tabs** list, move the zone that you configured as the default tab for the OSD to **Visible Tabs**.
 - d. Click **Apply**.

To set the HHR to OSD mode:

1. Press **g!** button, then press and hold **Media** button, and then select the desired zone (Bedroom). If using the gHR200 press the **Rooms** button and then select the desired zone.
2. Press the **g!** button to return to the main menu on the HHR touchscreen. If using the gHR200 press the **Home** button to return to the main menu.
3. Press the center arrow (**▲**) button to enter OSD mode.



The OSD command is sent to the g! Controller, to activate the OSD on your display, and change the HHR to OSD mode.



When in OSD mode, the HHR hard buttons will mimic the g1 remote buttons. The **HR2** has two additional hard buttons: Now Playing ► and g!, which are not present on the g! remote; so when the **Now Playing** button is pressed, it will jump the OSD to the **Now Playing** screen. When the **g!** button is pressed, it will jump to the OSD main menu. The **gHR200** has one button not present on the g1 Remote: **Rooms**. When pressed, the OSD will display all assigned media zones.

For details on other button features in OSD mode, see the OSD exercise in this lesson.

Lesson 16

Event Mapper



Overview

The Event Mapper is the area of the Configurator where advanced custom programming is performed. It allows you to execute commands in response to events detected by the system.

For example, when the front door to a home is opened, the front-hallway light is turned on. In this example, the event is the front door opening, and the command mapped to that event is “turn on the light”.

You will:

- Learn how custom events and macros are organized in the Configurator.
- Create Event Maps in response to sample system events.

Requirements

- g! system controller and g!Tools
- Completion of Lesson 3, *Configuring Security Systems* and Lesson 5, *Lighting Systems*.

Event Mapper Overview

Overview The Event Mapper Tab is where all the magic of the g system happens. Events can be based off of sub-system activity, initiated from a button press, setup to happen at certain times, and even more. Booleans and Variables help ensure that even one-way devices perform accurately.

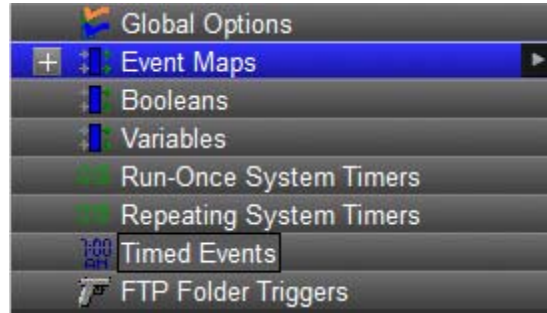

Quick Reference: Event Mapper Tab	
Global Options	Enables or disables all event maps
Event Maps	Events, conditions, and commands are added and managed here.
Booleans	True/False data type, intended to allow different actions depending on whether conditional events are true or false.
Variables	Logical set of attributes. Variables are values that can be used as conditions for events. The Variable data can be changed by other events in the Event Mapper tab.
Run-Once System Timers	Timer that triggers an event when it expires. Run-Once timers are started/re-started from a separate event map command and do not repeat themselves automatically.
Repeating System Timers	Timer that triggers an event when it expires then automatically resets and begins counting down again. Repeating timers are their own event and will repeat themselves indefinitely.
Timed Events	Timer that triggers an event at a designated time. Times may be sunrise, sunset, in relationship to sunrise and sunset, or at a specific time of day.
FTP Folder Triggers	Triggers an event when a specified folder is accessed.

Event Maps contain three distinct categories:

Events. An Event is something that has happened in the system and could come from any configured sub-system. Events are used to trigger Event Maps. These can be equated to “IF” statements. Multiple Events in this window will trigger as “OR”.

Conditions. Conditions are tests that allow control over when an Event should cause something to happen. Conditions place limits on when an Event Map should execute; as the Event *plus* the Condition must be met. These can be equated to “AND” statements. Multiple Conditions must ALL be met to trigger the Event Map and execute the commands.

Commands. Commands are the steps that are taken in response to a particular Event. These can be equated to THEN statements. Multiple Commands will execute in sequence.

Examples of each are shown below.

The screenshot shows the 'Event Map: Away Mode' configuration window. It has three main sections: Events, Conditions, and Commands. Each section has a table with columns for Sub-System, Type, Family, and Sys #. To the right of each table are 'Add' and 'Remove' buttons. At the bottom are 'Apply' and 'Test Commands Now' buttons.

Events Section:

Sub-System	Type	Family	Sys #
S			

Examples of Events include the front door opening, Dimmer 1 turning off, the House partition arming, or the Living Room audio zone turning on.

Conditions Section:

Sub-System	Type	Family	Sys #	State

Examples of Conditions include time of day, security zone status, or the state of a dimmer switch.

Commands Section:

Sub-System	Type	Family	Sys #

An example of a command is to “turn on light”.

How-to

Setting up an Event Map consists of the following steps:

1. Add the Event Map.
2. Set the events that should trigger the Event Map.
3. Add conditions to control if or when the Event Map runs (if needed).
4. Set the commands to execute when the Event Map runs.

Event Maps can be generated by entering the Event Mapper tab in Configurator, adding a new Event Map and then selecting the appropriate event (triggers), conditions and commands. This is the method detailed in the following exercises.

Event Maps can also be created on sub-systems tabs by right-clicking on a sub-system component and using the *Create Event Map for...* option, which will create a new event map with the selected trigger event already populated.

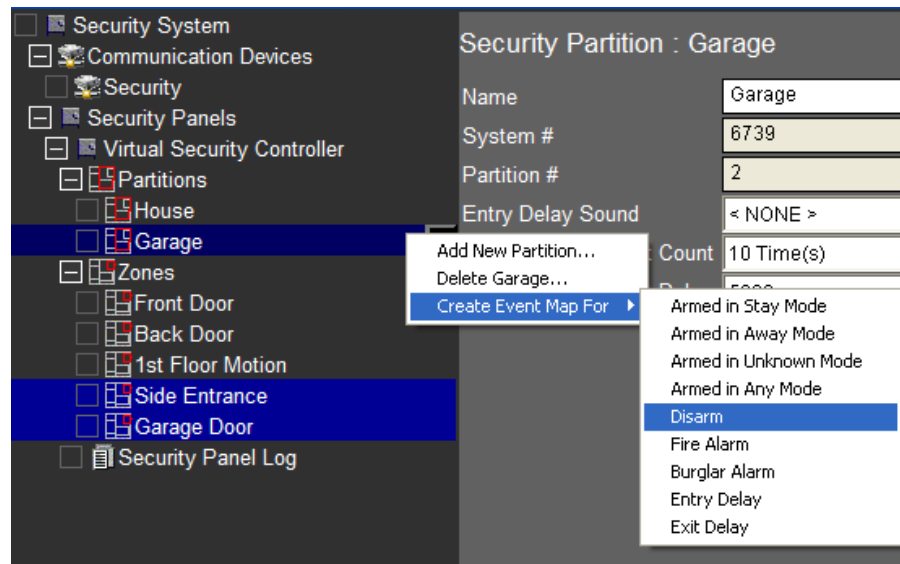
Example:*A Note about this Lesson*

The following exercises are intended to demonstrate the concepts of Event Mapper, and are not in any way comprehensive of the possibilities available within the Event Mapper function.

You should use these exercises and topics merely as a starting point for creating your own custom event maps.

Exercise 1: Arm the Security System on Away House Mode

Overview In this exercise, you will use Event Mapper to add additional functionality to a System Mode. System Modes will automatically tie into scheduling features on tabs such as Climate and Lighting, but through Event Maps additional functions can be added. Our sample function will be to automatically arm our Virtual Security System when the Away System Mode is selected.

Note: The alarm system cannot be automatically disarmed from a system mode or any other system command: the g! software does not support auto-disarm features as they could present a security risk.

How-to

1. Click the **Event Mapper** tab in the Configurator, then right-click **Event Maps** and **Add New Event Map** in the System Tree.

The Add New Event Map window opens.

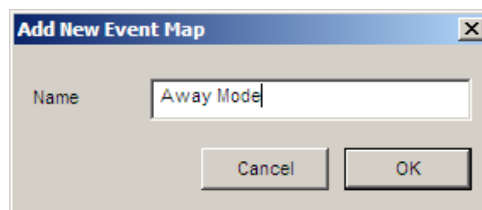
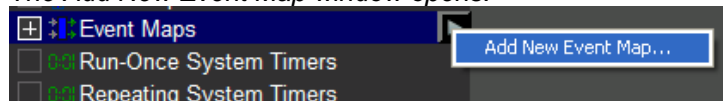

2. Name the Event Map **Away Mode**, and then click **OK**. *The Away Mode properties window displays to the right.*

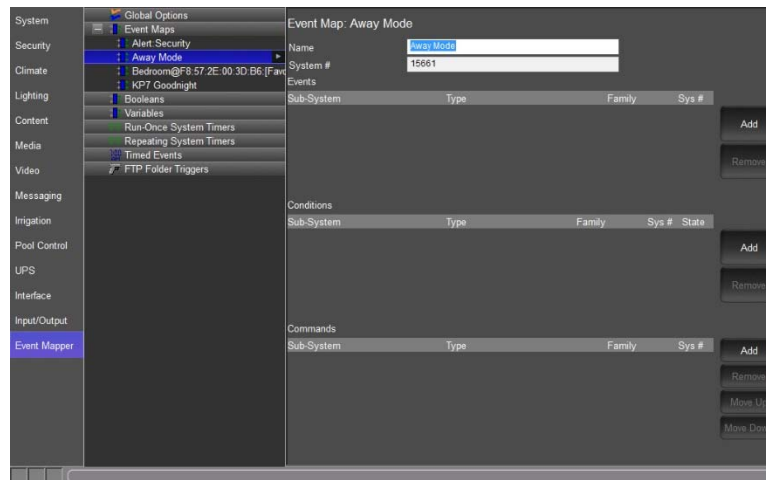

3. To the right of the **Events** section (top section), click the **Add** button. *The Add Event window opens.*
 - a. Select **General System** in the **System Family** section.
 - b. Select **System Notifications** in the **Event Groups** section.
 - c. Select **Away** in the **Available Events** section.

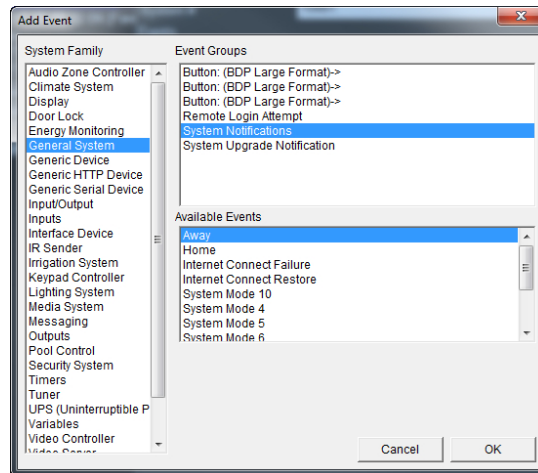

- d. Click **OK**. *The Add Event window closes and the event displays in the properties window.*
4. To the right of the **Commands** section (bottom section), click the **Add** button. *The Add Command window opens.*
 - a. Select **Security System** in the **System Family** section.
 - b. Select **House** in the **Event Groups** section.
 - c. Select **Auto Arm in Away Mode** in the **Available Events** section.

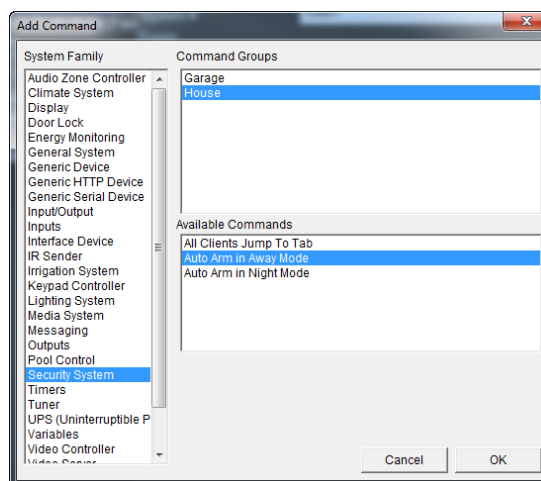

- d. Click **OK**. *The Add Command window closes and the command displays in the properties window.*

e. Your screen should now look like the one below.

The screenshot displays the Event Mapper software interface. On the left is a vertical navigation menu with categories: System, Security, Climate, Lighting, Content, Media, Video, Messaging, Irrigation, Pool Control, UPS, Interface, Input/Output, and Event Mapper (highlighted). Under 'Event Mapper', a tree view shows 'Global Options', 'Event Maps', 'Alert: Security', 'Away Mode' (selected), 'Bedroom@F8:57:2E:00:3D:B6 [Fav]', and 'KP7 Goodnight'. The main area is titled 'Event Map: Away Mode' and contains the following fields and tables:

- Name:** Away Mode
- System #:** 15661
- Events Table:**

Sub-System	Type	Family	Sys #
System Notifications	Away	General Syst...	1004
- Conditions Table:**

Sub-System	Type	Family	Sys #	State
------------	------	--------	-------	-------
- Commands Table:**

Sub-System	Type	Family	Sys #
House	Auto Arm in Away Mode	Security Syst...	7339

Buttons for 'Add' and 'Remove' are present next to each table. At the bottom right, there are 'Move Up' and 'Move Down' buttons. The interface has a dark grey theme.

Exercise 2: Set Home Mode on Security Disarm

Overview In this exercise, you will set up an Event Map to have the system automatically set the g! software System Mode to Home when the security system is disarmed.

How-to

1. On the **Event Mapper** tab, right-click **Event Maps**, then **Add New Event Map...** *The Event Map window opens.*

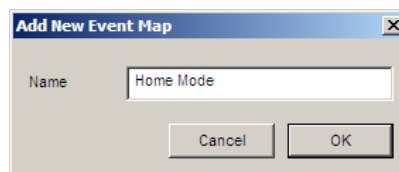
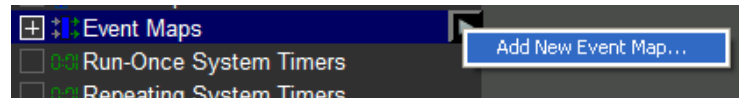

2. Name the Event Map **Home Mode**, then click **OK**. *The Home Mode properties window displays to the right.*
3. To the right of the **Events** section (top), click the **Add** button. *The Add Event window opens.*
 - a. Select **Security System** in the **System Family** section.
 - b. Select **House** in the **Event Groups** section.
 - c. Select **Disarm** in the **Available Events** section.

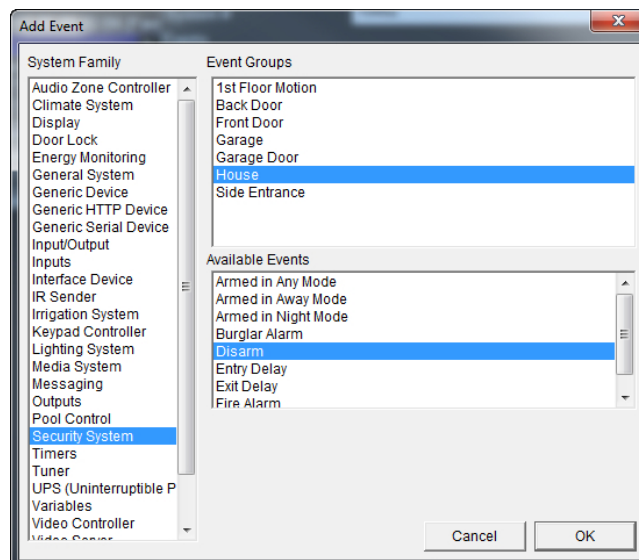

- d. Click **OK**. *The Add Event window closes and the event displays in the properties window.*

4. To the right of the **Commands** section (bottom), click the **Add** button.
The Add Command window opens.
 - a. Select **General System** in the **System Family** section.
 - b. Select **General System** in the **Event Groups** section.
 - c. Select **Switch to Home Mode** in the **Available Events** section.

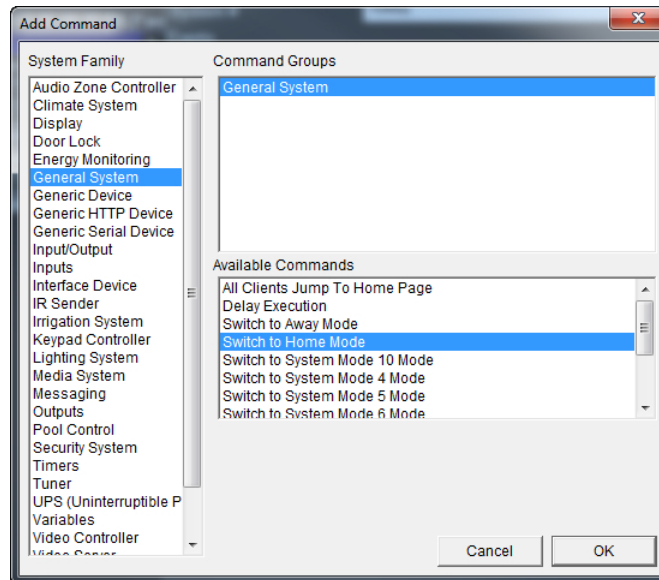

- d. Click **OK**. *The Add Command window closes and the command displays in the properties window.*
- e. Your screen should now look like below.

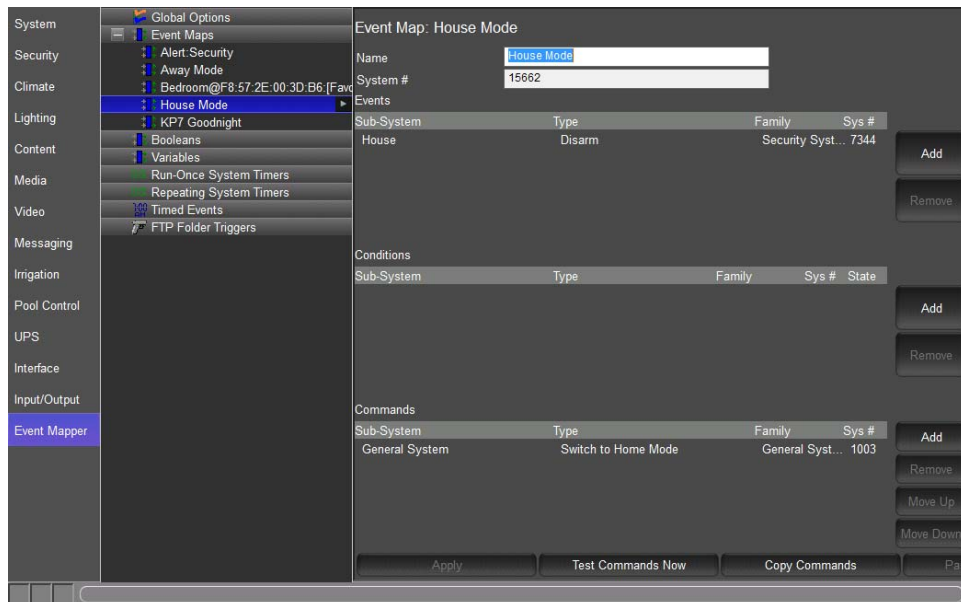

Exercise 3: Check the Commands

Overview In the following steps you will use the **Event Map Trace Info** window to see your Event Maps in action. Event Map Trace can be useful when creating and testing Event Maps to see events happening in real-time and observe when they may be triggering an Event Map.

How-to

1. On the **Event Mapper** tab, right click **Global Options** near the top in the System Tree, and click **Show Event Map Trace Info**.

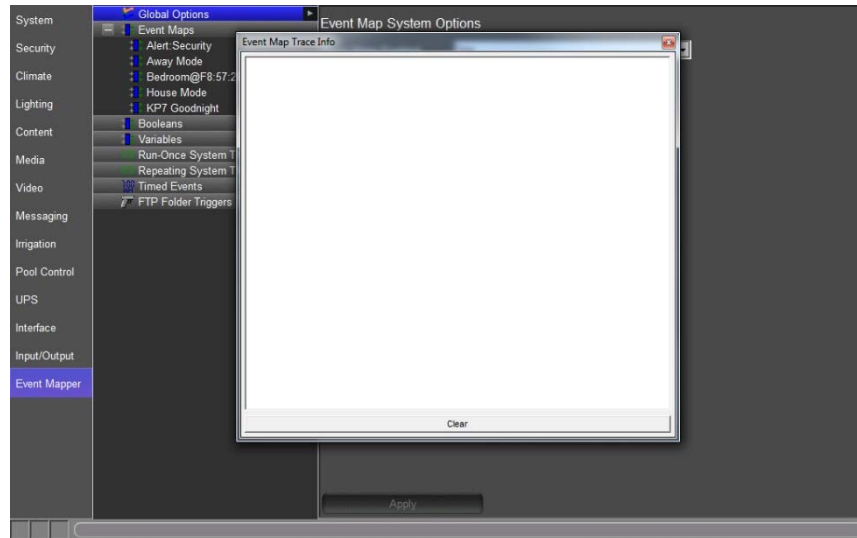

2. Open the **Viewer**, and arrange the windows so that you can see both the Trace window and the Viewer on your screen at the same time.

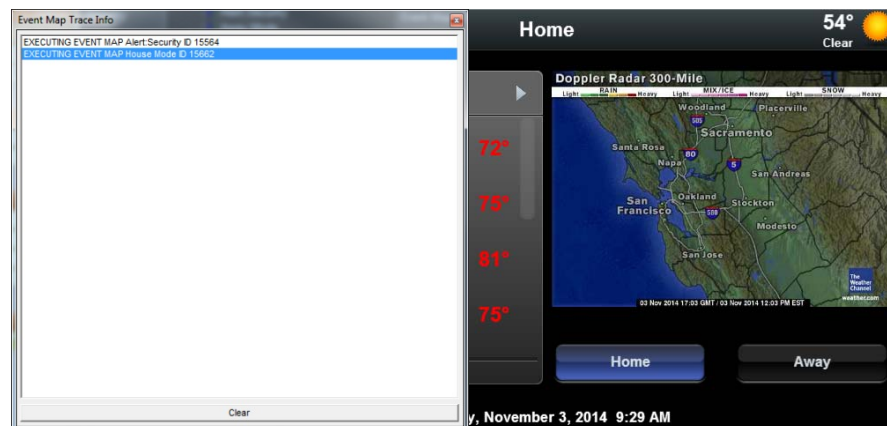

3. In the Viewer on the Home page, click the **Mode 3** button, then click **Away**.

*In the **Event Map Trace Info** window you will now see several lines of text, each representing an event in the system, or an Event Map executing.*

Note: An EVENT DETECTED message does not explicitly mean that it is going to trigger an Event Map; it is merely a notification of an event in the system which could **potentially** trigger an Event Map.

In the example above, we get an Event for Mode 3, which does not trip any Event Maps; and an event for the system mode changed to Away (System Notifications -> Away), which does trigger the Event Map "Away Mode".

Depending on what other configuration you have done in the system you may see several other events being detected during this test.



4. Click **g!** to access the main system icons then click the **Security** icon. Notice the results of the Event Map "Away Mode": The House Partition of our Security Panel is now "Armed in Away Mode".

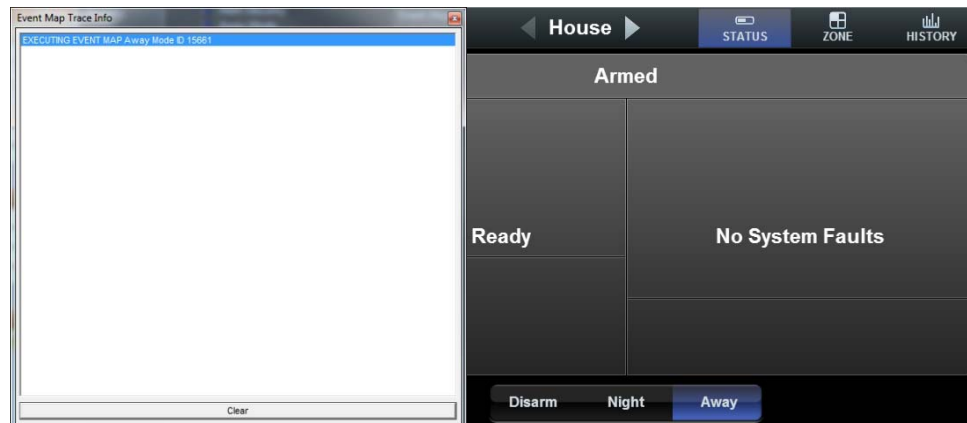

5. Test the Home Mode Event Map.
 - a. Tap the **Disarm** button, then enter **1...2...3...4...Enter** on the security keypad.
 - b. Notice that the Event Map trace displays **Event Detected House -> Disarm**, and this in turn causes the "Home Mode" Event Map to trigger.

6. Return to the Home page of the Viewer, and observe the results of the "Home Mode" Event Map. When you disarmed the House Partition, the System Mode was set to Home.



Exercise 4: Doorbell Triggers Jump to Video Tab

Overview In this exercise, you will use the sense input on an ELAN System Controller to create a reaction to someone pressing the door bell, which results in flipping all touch screens to a video feed. This example assumes that you have wired the door bell or a third-party door station unit appropriately to the Sense Input and have already configured a Video camera in the system. Note that ELAN system controllers will have Sense Inputs pre-configured by default.

- How-to*
1. Add a new Event Map and name it "**Input: Door Bell – Video Flip**" or similar.
 2. Add an EVENT for the Chassis Input Shorted:
 - System Family: **Inputs**
 - Event Group: **SC Input Controller: Sense Input 1**
 - Event: **State Change Off->ON**

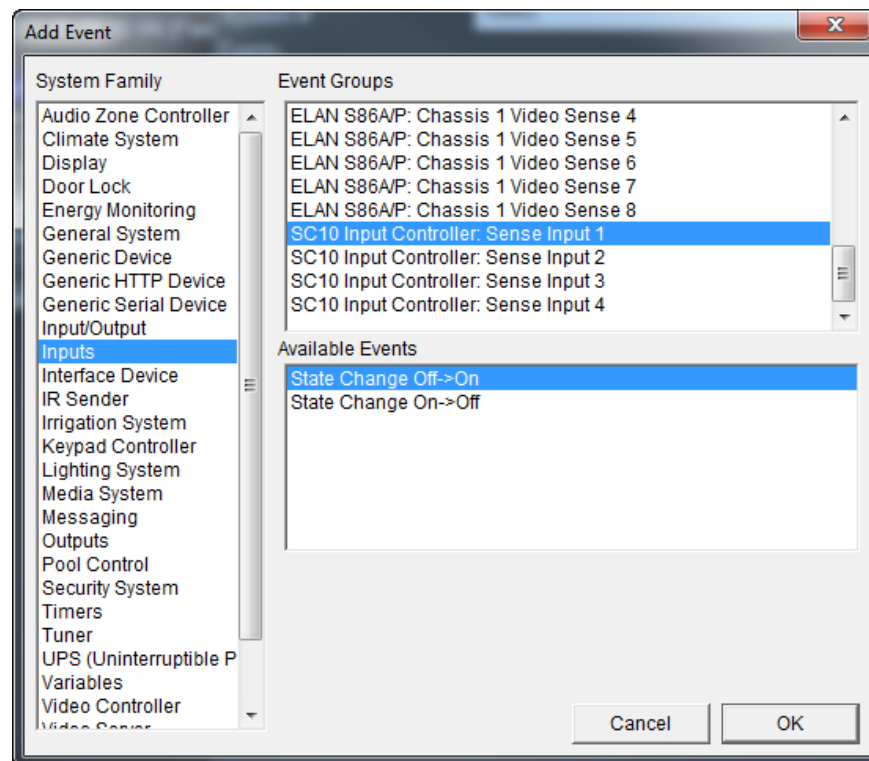

3. Add a command to flip touch screens to the video feed. Note that you can choose to either flip all touch screens to the video feed (a), or select only specific screens (b).

- a. **Flip all touch screens to the video feed:** Add a Command for the touch screens to flip to a certain video feed by choosing **Add Command** and selecting the System Family: **Video System**, Command Group: **(desired camera feed)**, and Command: **All Clients Jump to Tab**. In the example below, the **Front Door** IP Camera will be displayed on all touch screens when the Input is turned on:

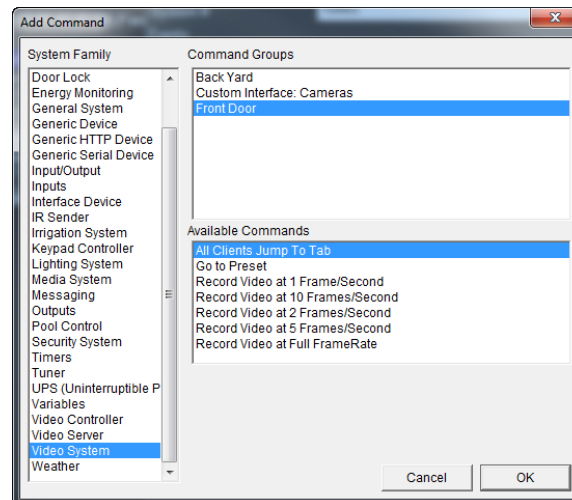

- b. **Flip only a specific touch screen to the video feed:** Add a Command for a touch screen to flip to a certain video feed, by choosing **Add Command** and selecting System Family: **Interface Device**, Command Group: **Client: (desired touch screen)**, Command: **Jump to Video Page**, and Options: **desired camera feed**. In the example below, the **Living Room TP7** screen will jump to the Video Tab and show the **Front Door** video feed:

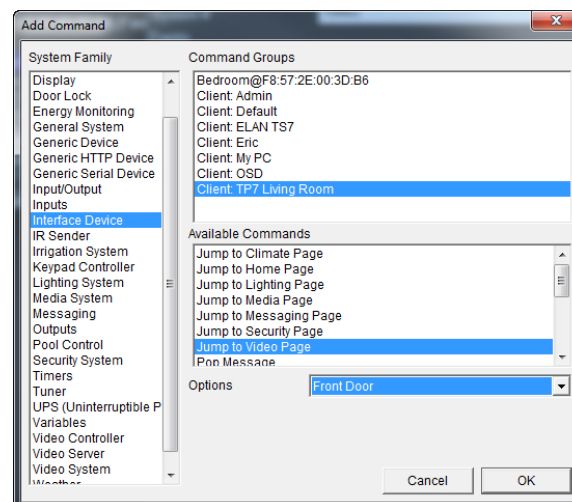

Exercise 5: Use Relay Outputs to Open a Gate

Overview In this exercise, you will use the Relay Output on an ELAN System Controller to close the contact controlling a powered driveway gate. This exercise works well with Exercise 4 if a button to actuate the relay is placed on the Video Page, so that the homeowner can open the gate after glancing at the Video feed to see who pressed the door bell. This example assumes that you have wired the gate control unit appropriately to the Relay Output, and have created a button on a Custom Tab with the Video feed. Note that the ELAN system controllers will have Relay Outputs pre-configured by default.

Note: These basic steps can be followed for other contact closures, such as those on the back of a Global Cache.

How-To

1. Add an EVENT for the Button Press (assumes using a standard button):
 - a. Right-click the button on your Custom Tab and select **Create Event Map For > Button Press**

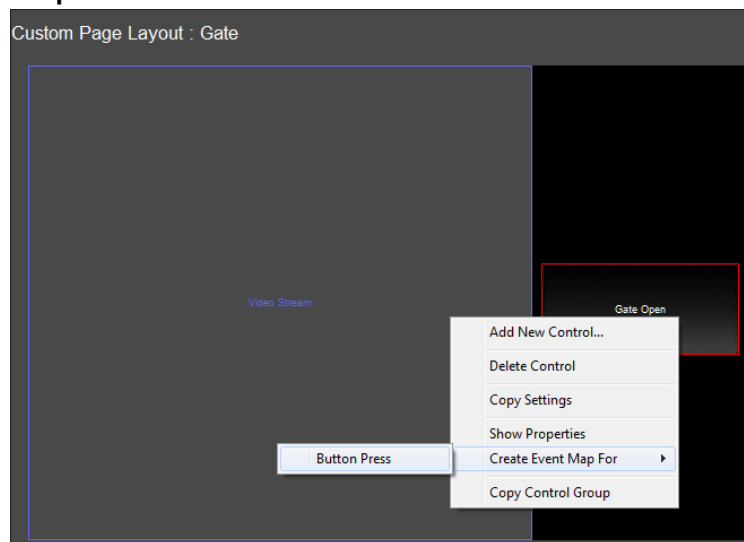

- b. Name the Event Map "**Output: Open Gate**" or something similar.

- c. Observe that the Event is pre-populated on this event map, showing the name of the Custom tab, resolution, and button name.

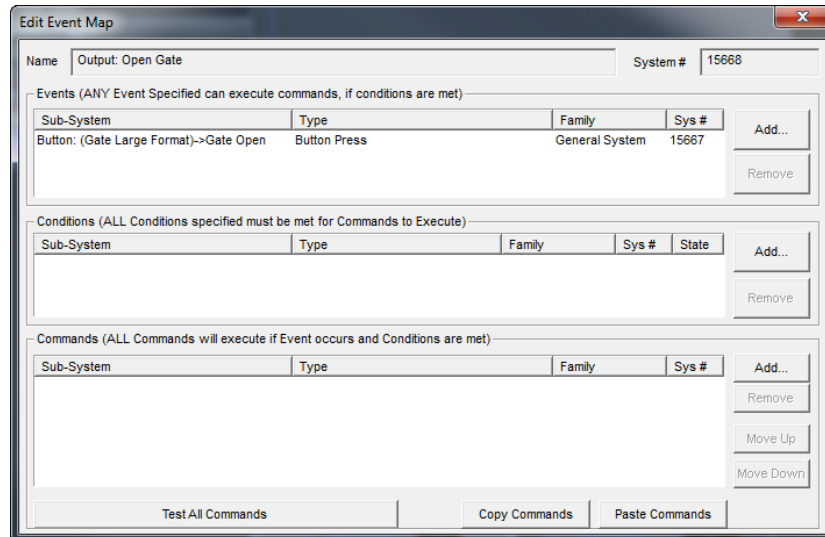

2. Add a command in the Commands row to close the Relay, which will open the gate.
In this example, we are assuming the gate requires relay 1 on the gSC controller to be closed for 3 seconds.
 - System Family: **Outputs**
 - Command Group: **SCXX Output Controller: Relay Output 1**
 - Available Commands: **Turn Output ON**
 - Select **OK**.

3. Add a command in the Commands row to Delay the next command by 3 seconds:
 - System Family: **General System**
 - Command Group: **General System**
 - Available Commands: **Delay Execution**
 - Time: **3 Seconds**
 - Select **OK**.

Note: You may need to adjust this time, or may not need the delay at all depending on the specific setup.

4. Add a command in the Commands row to open the relay:
 - System Family: **Outputs**
 - Command Group: **SCXX Output Controller: Relay Output 1**
 - Command: **Turn Output OFF.**
 - Select **OK.**

Edit Event Map

Name: System #:

Events (ANY Event Specified can execute commands, if conditions are met)

Sub-System	Type	Family	Sys #
Button: (Gate Large Format)->Gate Open	Button Press	General System	15667

Conditions (ALL Conditions specified must be met for Commands to Execute)

Sub-System	Type	Family	Sys #	State
------------	------	--------	-------	-------

Commands (ALL Commands will execute if Event occurs and Conditions are met)

Sub-System	Type	Family	Sys #
SC10 Output Controller: Relay 1	Turn Output On	Outputs	1671
Delay Execution	00:00:03:000	General System	1043
SC10 Output Controller: Relay 1	Turn Output Off	Outputs	1672

Test All Commands Copy Commands Paste Commands

Exercise 6: Run-Once Timer – Porch Light Off after 5 Minutes

Overview In this exercise, you will use a door bell button press to trigger a Run-Once Timer. The event will only happen at night. This example will use one event containing a doorbell button press turning on a porch light and starting a 5 minute Run-Once Timer. A second event will be created to turn off the porch light after the Run-Once Timer expires. This example assumes that you have wired the doorbell or a third-party door station unit appropriately to the Sense Input and have installed, and configured, a compatible lighting control system into the g system.

How-to

1. Add a **Run-Once System Timer** in the **Event Mapper** tab:
 - Right-Click on **Run-Once System Timers** and select **Add New Run-Once System Timer...**

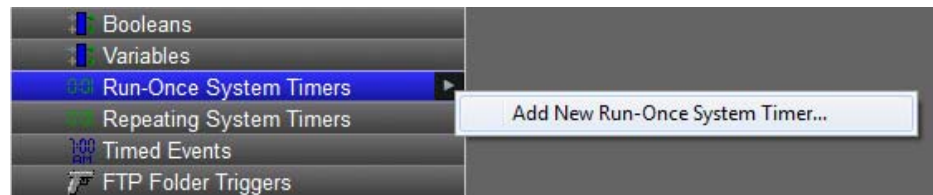

- Enter **5 Min Porch Light** as the name of the new timer.

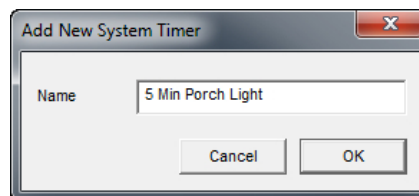

- In the **Base Time (Seconds)** field enter **300**. *All timers use seconds to determine their length.*

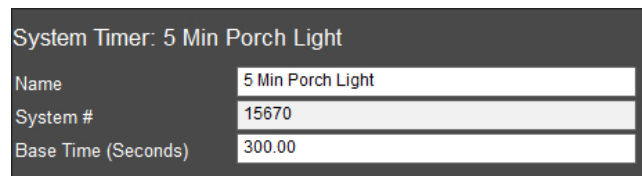

- Select **Apply** when finished.

2. Navigate to the **Event Maps** node and add a **new Event Map**. Name it **“Input: Door Bell – Porch Light”** or similar.
3. Add an **EVENT** for the Chassis Input Shorted:
 - System Family: **Inputs**
 - Event Group: **SC Input Controller: Sense Input 1**
 - Event: **State Change Off->ON**
 - Select **OK**.

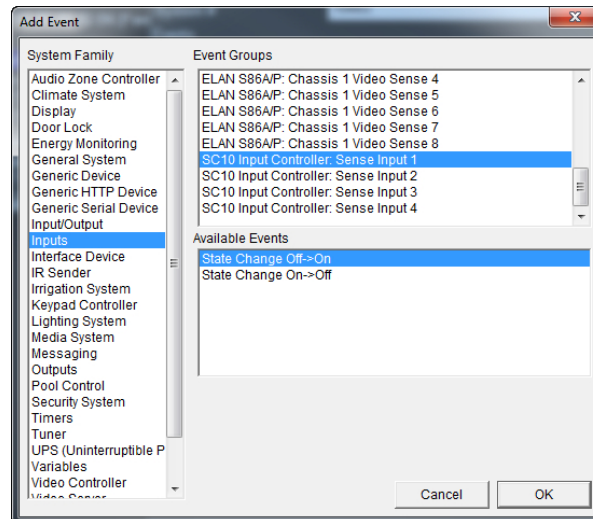

4. Add a condition to the Conditions row for establishing when to issue the command.
 - System Family: **General System**
 - Condition Group: **Day/Night Time**
 - Available Conditions: **Is Day Time**
 - State Must Be: **False**
 - Select **OK**.

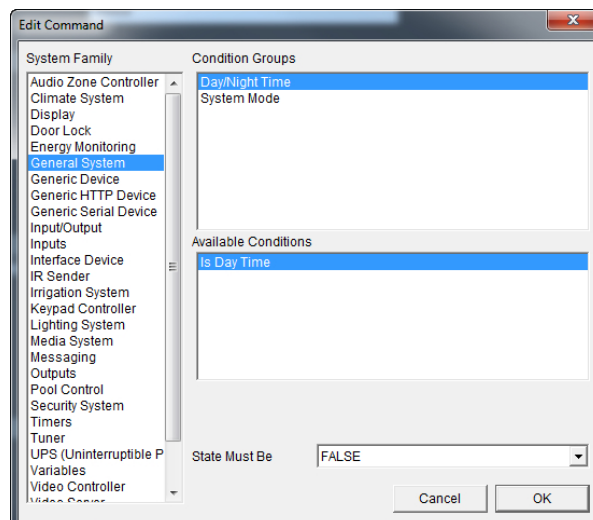

5. Add a command to the Commands row to turn on the porch light.
 - System Family: **Lighting System**
 - Command Group: **Switch/Dimmer: Front Porch**
 - Available Commands: **ON**
 - Select **OK**.

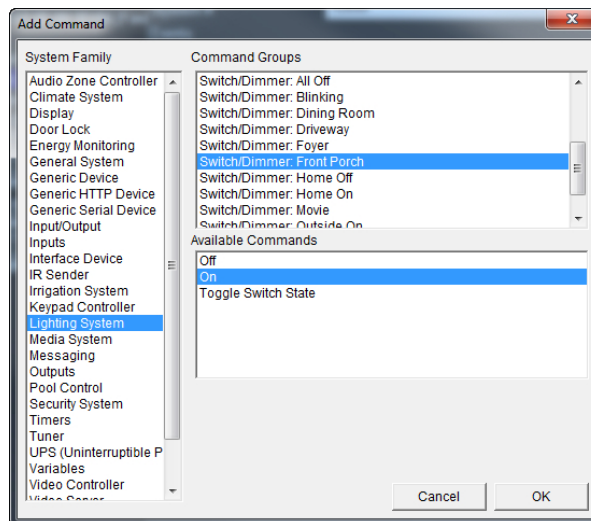

6. Add a command to the Commands row to start the Run-Once System Timer.
 - System Family: **Timers**
 - Command Group: **5 Min Porch Light**
 - Available Commands: **Start/Restart Timer: 5 Minutes, 0 Sec, 0 msec**
 - Select **OK**.

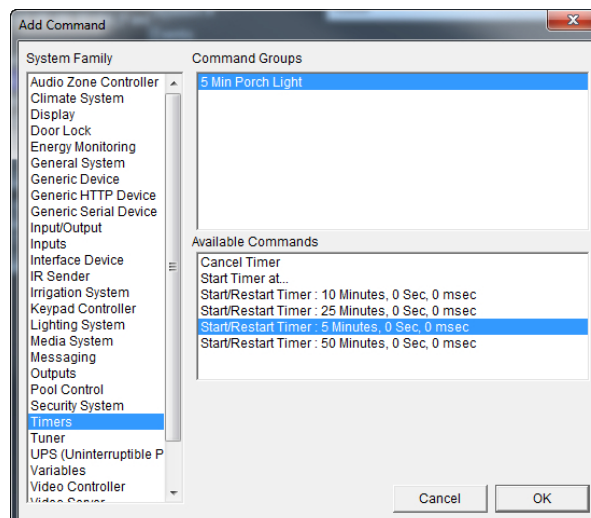

7. Add a **new Event Map**. Name it **"Timer: 5 Min Porch Light Expired"** or similar.
8. Add an **EVENT** for the timer expiring:
 - System Family: **Timers**
 - Event Group: **5 Min Porch Light**
 - Event: **Timer Expired**
 - Select **OK**.

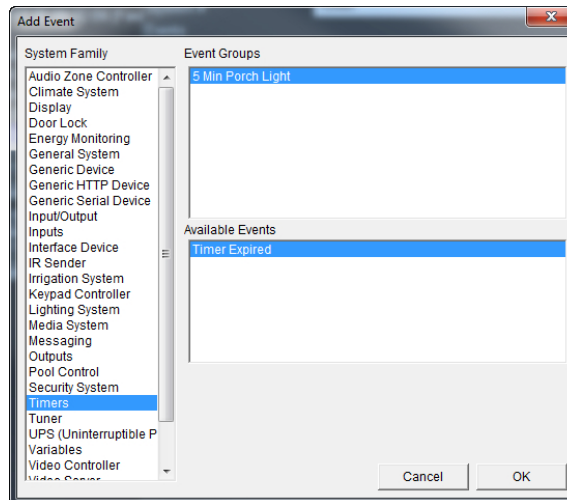

9. Add a command to the Commands row to turn on the porch light.
 - System Family: **Lighting System**
 - Command Group: **Switch/Dimmer: Front Porch**
 - Available Commands: **OFF**
 - Select **OK**.

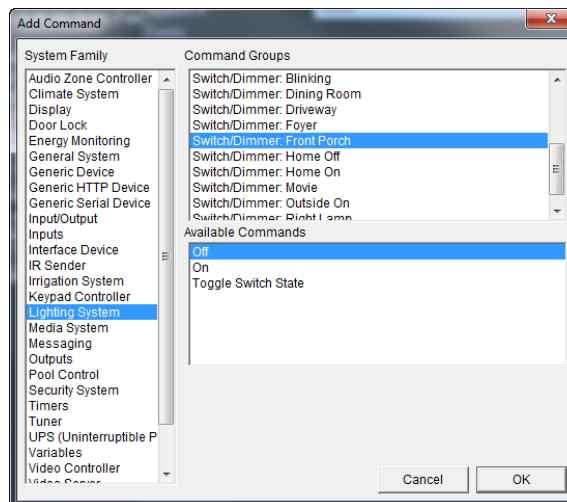

Note: A condition is not needed in this event. The Day/Night Time condition was met in the event that triggered the Run-Once System Timer.

When finished you should have 2 Event Maps that look similar to the examples shown below:

Ex: Input: Door Bell – Porch Light

The screenshot shows the 'Event Mapper' window with the following configuration:

- Name:** Input: Door Bell - Porch Light
- System #:** 15669
- Events:**

Sub-System	Type	Family	Sys #
SC10 Input Controller: Sense Inpu...	State Change Off->On	Inputs	1729
- Conditions:**

Sub-System	Type	Family	Sys #	State
Day/Night Time	Is Day Time	General Syst...	1041	FAL...
- Commands:**

Sub-System	Type	Family	Sys #
Switch/Dimmer: Front Porch	On	Lighting Syst...	14013
5 Min Porch Light	Start/Restart Timer : 5 Minutes, 0 ...	Timers	15673

Ex: Timer: 5 Min Porch Light Expired

The screenshot shows the 'Event Mapper' window with the following configuration:

- Name:** Timer: 5 Min Porch Light Expired
- System #:** 15680
- Events:**

Sub-System	Type	Family	Sys #
5 Min Porch Light	Timer Expired	Timers	15671
- Commands:**

Sub-System	Type	Family	Sys #
Switch/Dimmer: Front Porch	Off	Lighting Syst...	14014

Exercise 7: Timed Event – Outside Lights On and Off

Overview In this exercise, you will use a Timed Event to turn lights on and off. This event will happen a specific times of the day. This example will use two events, on to turn the lights on and one to turn the lights off. This example assumes that you have installed and configured a compatible lighting control system into the g system.

Timed Events allow for events to be triggered at a specific time of day, week, at sunrise, at sunset, or in relationship to sunrise and sunset.

Timed Events are characterized by one of three Time Types and may executed on specific days or every day.

Quick Reference: Timed Events	
Name	Name of the Timed Event
Time Type	Type of timed event. Choices are Clock, Relative Sunrise, and Relative Sunset.
Daily Start Time: Clock	Available for Clock Time Types. Sets the time of day the Timed Event will trigger an event map.
Daily Start Time: Relative Sunrise/Sunset	Available for Relative Sunrise/Sunset Time Types. Sets the time in relationship to sunrise/sunset the Timed Event will trigger an event map. Times may be set to +/- 3 Hours in 10 minute increments or exactly at Sunrise/Sunset.
Days to Execute	Defines the days of the week that the Timed Event will be active.

How-To

1. Add two **Timed Events** in the **Event Mapper** tab:
 - Right-Click on **Timed Events** and select **Add New Timed Event**

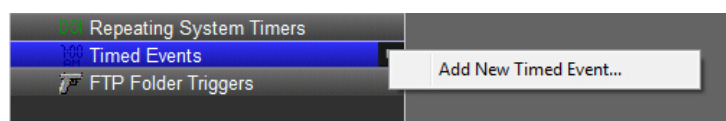

- In the Add New Timed Event window enter the name **11PM: Lights On.**
- Select **OK.**
- Select **Fri** and **Sat** to remove them from this event.
- Select **Apply.**

 A screenshot of the 'System Timer: 11 PM: Lights On' configuration window. The window contains the following fields:

- Name: 11 PM: Lights On
- System #: 15681
- Time Type: Clock
- Daily Start Time: 12:00 AM
- Daily Start Time: 3:00 Before
- Days to Execute: Mon, Tue, Wed, Thu, Fri, Sat, Sun (with Fri and Sat buttons highlighted in blue, indicating they are selected for removal).

2. Right-Click on **Timed Events** and select **Add New Timed Event**
 - In the Add New Timed Event window enter the name **Sunrise: Lights Off**.
 - Select **OK**.
 - Select **Fri** and **Sat** to remove them from this event.
 - Select **Apply**.

System Timer: Sunrise: Lights Off

Name: Sunrise: Lights Off

System #: 15683

Time Type: Clock

Daily Start Time: 12:00 AM

Daily Start Time: 3:00 Before

Days to Execute: Mon, Tue, Wed, Thu, Fri, Sat, Sun

Note: Timed Events are only ran on days highlighted in blue.

3. Add a **new Event Map**. Name it "**Timer: 11PM: Lights On**" or similar.
4. Add an **EVENT** for when the timer expires:
 - System Family: **Timers**
 - Event Group: **11PM: Lights On**
 - Event: **Timed Event**
 - Select **OK**.

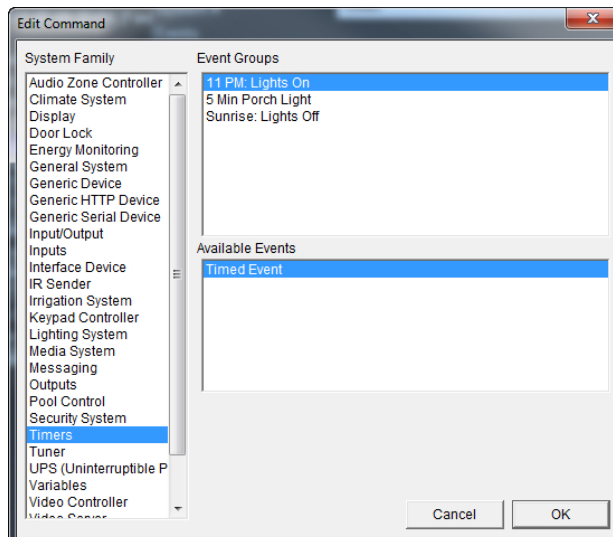

5. Add a command to the Commands row to turn on the Outside lights.
 - System Family: **Lighting System**
 - Command Group: **Switch/Dimmer: Outside**
 - Available Commands: **On**
 - Select **OK**.

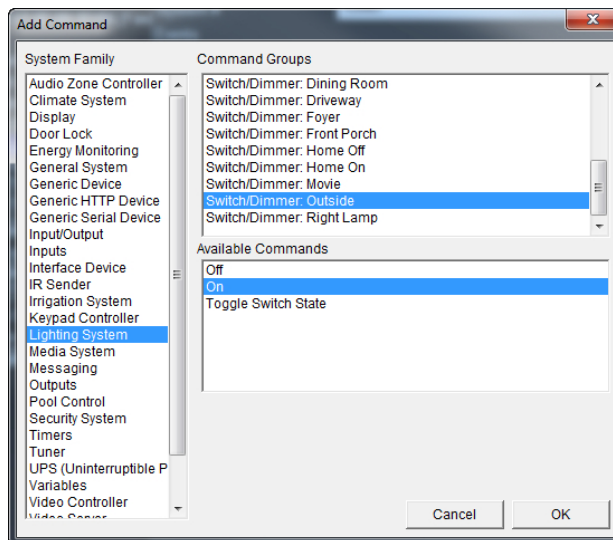

6. Add a **new Event Map**. Name it "**Timer: Sunrise: Lights Off**" or similar.
7. Add an **EVENT** for when the timer expires:
 - System Family: **Timers**
 - Event Group: **Sunrise: Lights Off**
 - Event: **Timed Event**
 - Select **OK**.

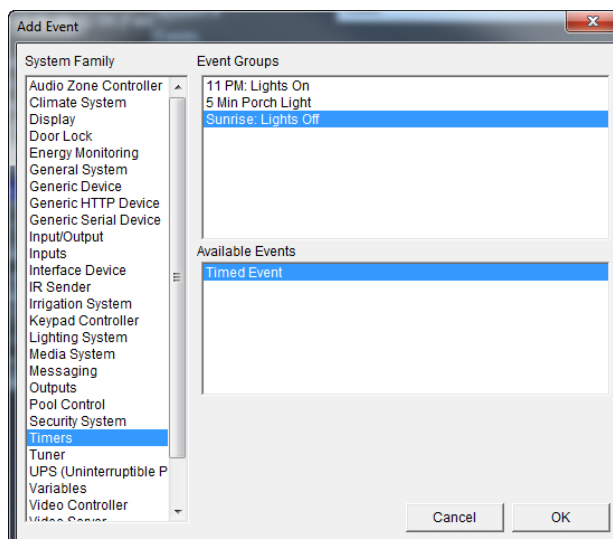

8. Add a command to the Commands row to turn off the Outside lights.
 - System Family: **Lighting System**
 - Command Group: **Switch/Dimmer: Outside**
 - Available Commands: **Off**
 - Select **OK**.

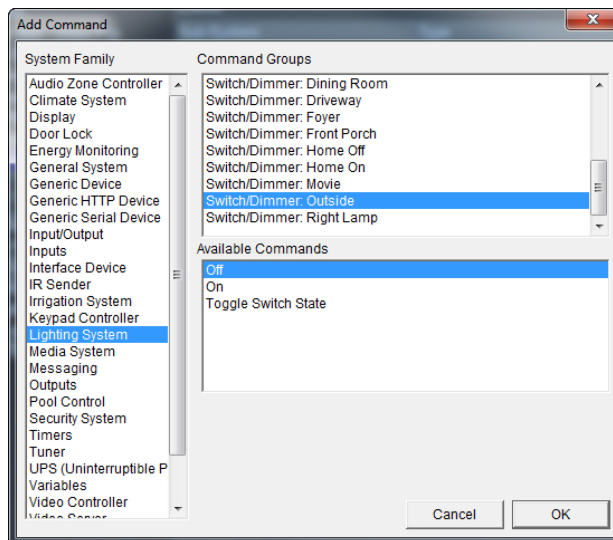

When finished you should have 2 Event Maps that look similar to the examples shown below:

Ex: Timer: 11PM: Lights On

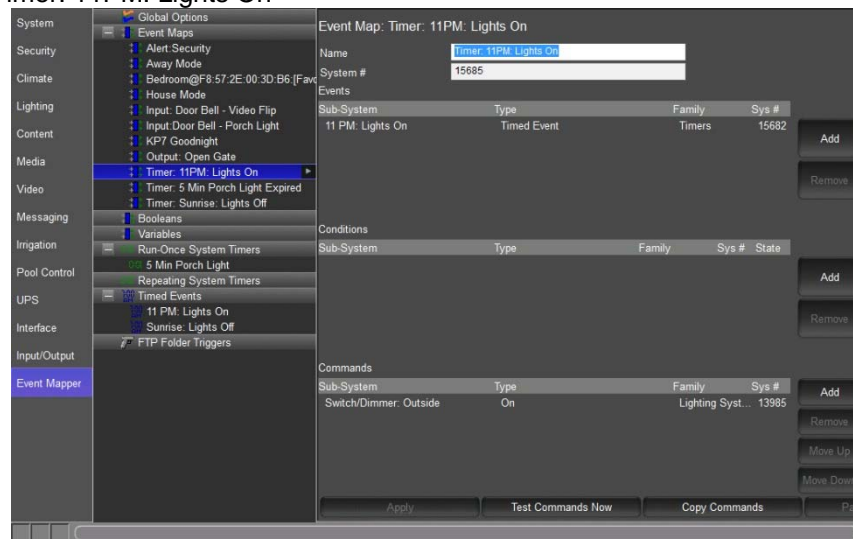

Ex: Timer: Sunrise: Lights Off

The screenshot displays the Event Mapper software interface. On the left is a navigation tree with categories like System, Security, Climate, Lighting, Content, Media, Video, Messaging, Irrigation, Pool Control, UPS, Interface, Input/Output, and Event Mapper. The 'Event Mapper' category is selected. The main area shows the configuration for an event map titled 'Event Map: Timer: Sunrise: Lights Off'. The 'Name' field contains 'Timer: Sunrise: Lights On' and the 'System #' is '15686'. Below this are three tables: 'Events', 'Conditions', and 'Commands'. The 'Events' table has one entry: 'Sunrise: Lights Off' of type 'Timed Event' in the 'Timers' family, system # '15684'. The 'Conditions' table is empty. The 'Commands' table has one entry: 'Switch/Dimmer: Outside' of type 'Off' in the 'Lighting Syst...' family, system # '13986'. At the bottom are buttons for 'Apply', 'Test Commands Now', 'Copy Commands', and 'Paste'.

Sub-System	Type	Family	Sys #
Sunrise: Lights Off	Timed Event	Timers	15684

Sub-System	Type	Family	Sys #	State
------------	------	--------	-------	-------

Sub-System	Type	Family	Sys #
Switch/Dimmer: Outside	Off	Lighting Syst...	13986

AV Macro Examples

Overview You can use the Event Mapper to create macros to automate a variety of A/V functions. This section presents examples of some common macro functions.

Note: Use this section for examples and ideas, but bear in mind it is not a comprehensive list of possible functions.

Powering On a Source

The following text uses the example of turning on a DVD Player, but the steps below can be used with any Source Interface. Event Maps may also be used to turn off IR, Generic Serial, or sources with built-in drivers.

1. In Configurator on the **Media** tab, right-click the **Generic DVD** interface under **Sources** and select **Create Event Map For > Selected into one or more Zones**.

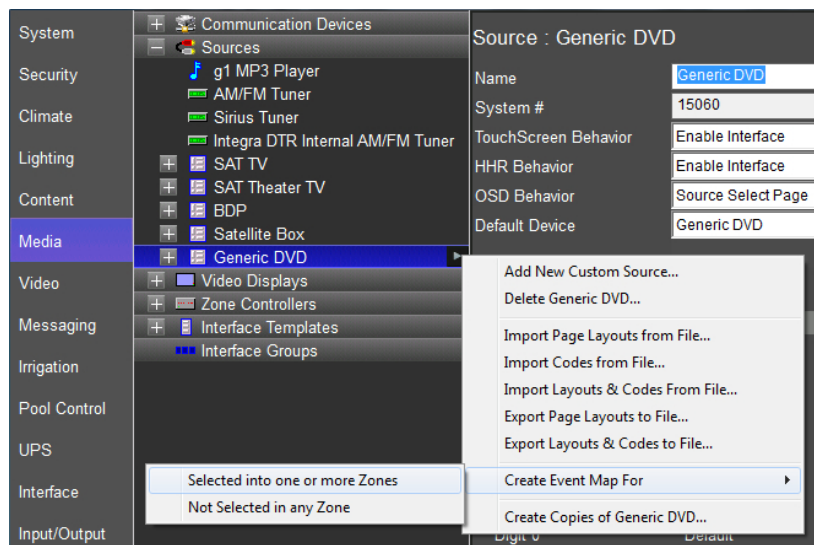

2. Add a command to send the Power On Serial Code to the DVD Player. Click **Add** next to the Commands box, then select **System Family: Generic Serial Device**. Scroll to the correct Serial Code and select **Send Via Default Device**.

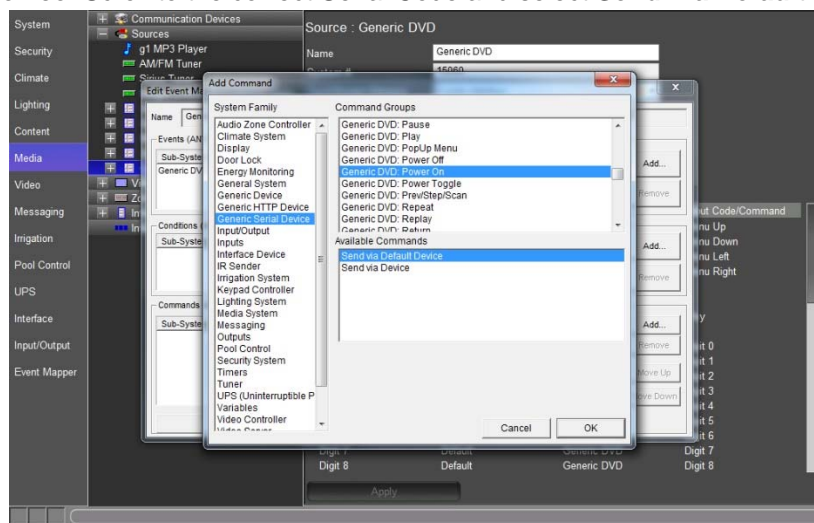

- Whenever the DVD Player interface is selected, the g! software will automatically send an IR command to the DVD Player to Power ON.

Note: You may wish to also program a second Event Map to perform the inverse. Use the steps above to create an Event Map to Power Off the DVD Player when it is “not selected in any zones”.

- Right-click the **Generic DVD** interface under **Sources** and select **Create Event Map For > Not Selected in any Zone**.

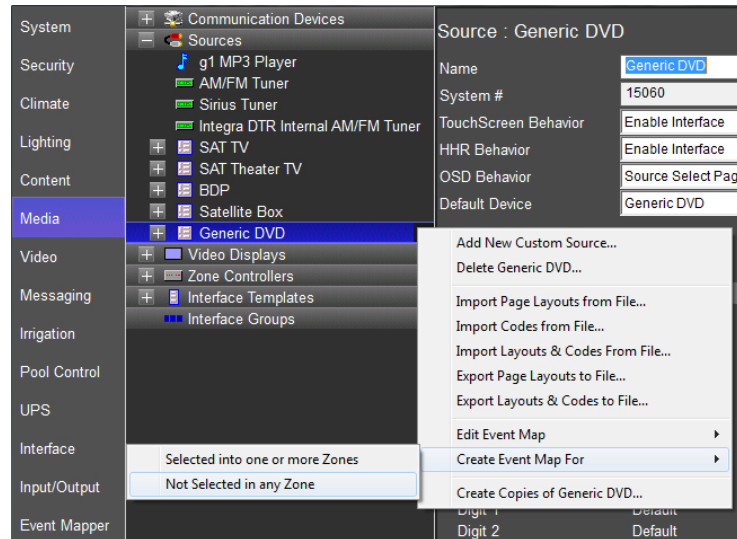

- Add a command to send the Power Off Serial Code to the DVD Player. Click **Add** next to the Commands box, then select **System Family: Generic Serial Device**. Scroll to the correct Serial Code and select **Send Via Default Device**.

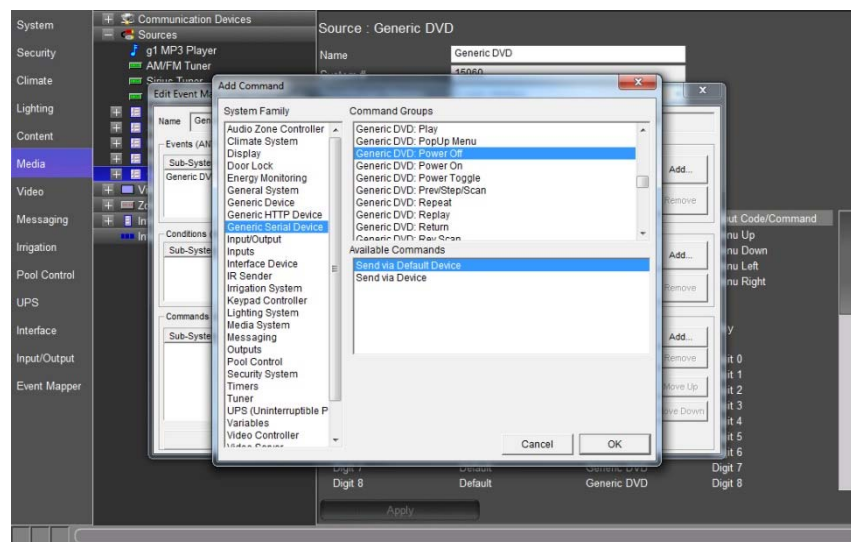

- Close the Event Map window when finished.
- Repeat for additional Source Devices if desired.

React to IR input for Event Map Triggering:

By using an IR receiver such as the Global Cache IRE, the g! software can trigger events off the reception of specific IR codes.

1. Add your IR Receiver as per its Integration Note.
2. Add an IR Device and learn the IR code(s) you wish to use to trigger the event. If possible, learn the IR through the same method IR will come in to trigger the event.
3. Edit the IR Device properties and set **Decode IR from this device** to **Yes**.



4. Either right-click on the desired IR code and Add an Event Map for IR Code Begin Receive or go to the Event Mapper tab and add a new event with the trigger: System Family: Input/Output, Event Group: IR Device: IR Code, and Available Event: IR Code Begin (or End) Receive.

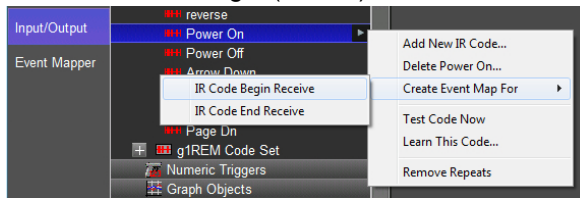

-OR-

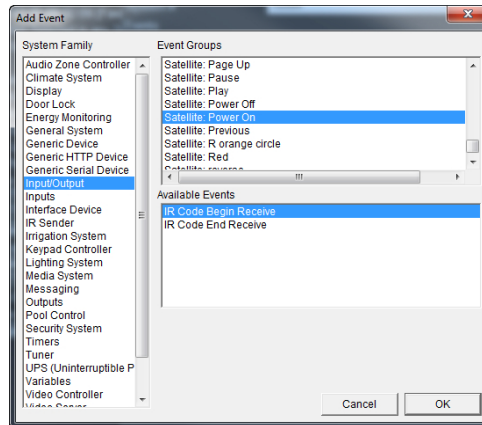

Note: The above example assumes a single IR code input to trigger a single event in the g! software, you can choose either IR Code Begin Receive or IR Code End Receive. However, if you were to input IR continuously, such as with a volume control or a light dimmer, Begin Receive allows you to set an Event Map when the button is *pressed*, and End Receive allows you to set a different event map for when the button is *released*.

5. Add commands to the event as desired.

All Off:

This exercise demonstrates how to use an event map to turn off multiple devices. In this example, you will turn off all audio sources whenever no zones are active on the zone controller.

1. In Configurator, on the **Media** Tab, right-click the name of the zone controller. Select **Create an Event Map For > All Zones Turned Off**.

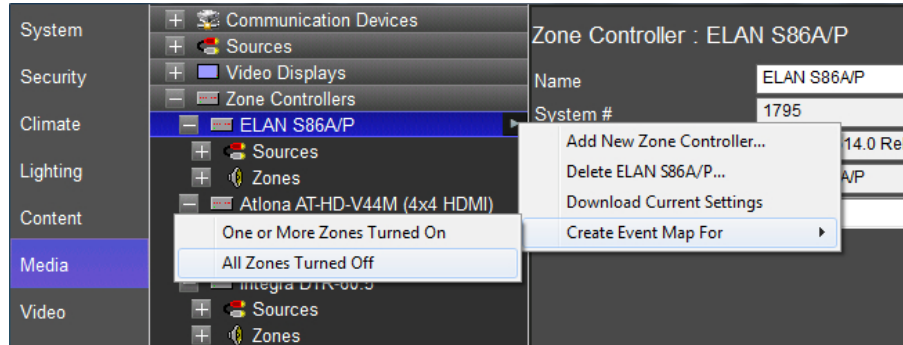

2. Name the event **All MRA Zones Off** or similar and click **OK**.
3. Add commands to turn off the various sources.

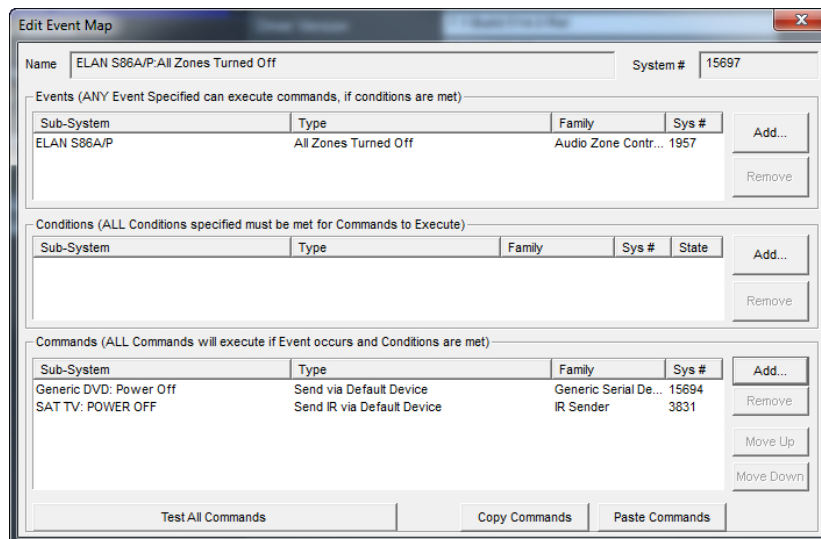
*Party Mode:*

In this example, you will configure an additional System Mode to be used to set the house for a party. In this event map, you will use the Whole House Music function built into the ELAN S86 Zone Controller, but it is possible to also configure a similar function by editing individual zones.

1. Navigate to the System Tab->System Modes and add a **New System Mode** named **Party**, and place a System Mode button on a Custom Tab or Home Page to activate the Event Map. Please see Lesson 13, *Interfaces* for details.
2. Configure Lighting and Climate scheduling information as desired.
3. Add a New Event Map and name it **Party Mode** or similar.

4. Add an Event from System Family: **General System**, Event Groups: **System Notifications**, and choose the **System Mode Party**.

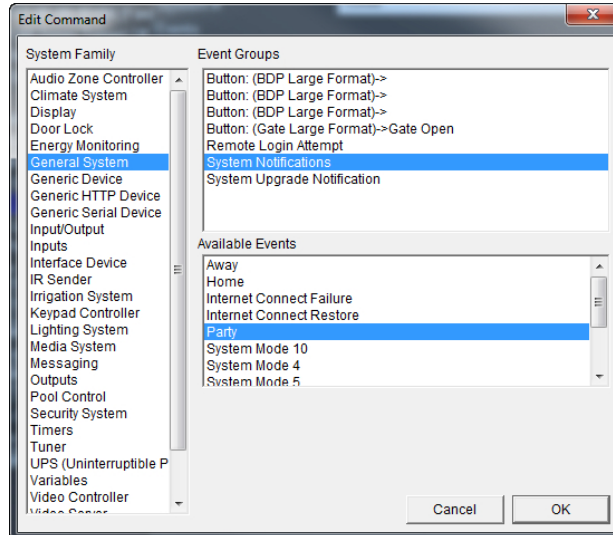

5. Add Commands as desired. For example, turn on the XM radio, select the XM Radio source, set volume on a particular zone, and then enable Whole House Music Mode for the S86.

Sub-System	Type	Family	Sys #	
Sirius Tuner	Turn Tuner On	Tuner	1792	Add
Living Room < ELAN S86A/P >	Set Source to Source 02	Audio Zone C...	1837	Remove
Living Room < ELAN S86A/P >	Set Volume To 45 %	Audio Zone C...	1831	Move Up
Living Room < ELAN S86A/P >	Set Option Whole House Mode On	Audio Zone C...	1798	Move Down

Apply Test Commands Now Copy Commands Paste

