



VSE2

**100 WATT HIGH POWER
ELECTRONIC VOLUME CONTROL**

by ELAN



This ELAN Volume Control is NTRL certified to comply with local building codes. Use Class 2 wiring and methods per National Electrical Code NFPA70. Install in a Listed electrical box.



Contents

Introduction	3
Features.....	3
Installation	6
Rough-in	6
Wiring.....	6
Speaker Connections	7
RJ45 Connections	8
Sense Input Connections	9
IR Input	10
Configuration/Applications	11
Stand-Alone Configuration	11
ELAN System Configurations	13
ELAN S6 System Overview	14
ELAN S8.6 System Overview	15
ELAN S12 System Overview	16
ELAN Z•System Overview	17
PVSE Precision Panel	18
PZ600 Precision Panel	19
ELAN S8.6/S12 Connections	20
w/ COM2 and VSE2	20
Override Connections	21
ELAN System6	21
ELAN S8.6/S12	21
ELAN Z•System	22
ELAN Z•System Connections	23
Maximum Number Of VSE2s	23
Connecting Multiple VSE2s	24



Settings	25
Default Volume Level	25
Override Volume Level	26
Sleep Mode	27
Programmed Settings	28
Code Group	29
Variable Speed Ramping.....	30
Volume Jumps	31
On Default Volume Check	32
Sense Input	33
Talkback LED	34
Factory Default	35
Impedance Match Settings	35
Operation	37
Turning the VSE2 ON	37
Turning the VSE2 OFF	38
Controlling Volume.....	38
Muting the Volume	39
TROUBLESHOOTING	39
Specifications	41
Warranty	Back Page

Introduction

ELAN's VSE2 is an electronic 12 step stereo Volume Control with Variable Impedance Match settings of 1X, 2X, 4X and 8X designed for use with amplifiers of up to 100 Watts per channel output.

The VSE2 features an IR receiver which passes IR data to other sources as well as accepting IR information from remote controls or other IR devices.

The VSE2 also features an IR input so that external controllers (Z•Pad Keypads, VIA!® Color LCD Touchpanels, etc.) can be hard wired to this device without using an IR emitter. Additionally, the VSE2 features ELAN's patented Page/Doorbell Override to work with ELAN communication controllers such as the COM2. Impedance Match adjustments allow multiple pairs of speakers to be connected to the same amplifier channels without damaging the amplifier.

Features

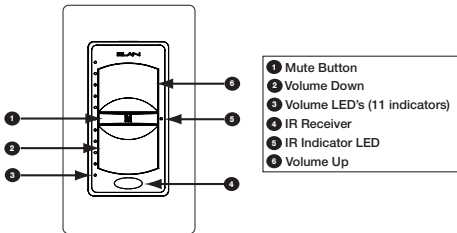



- **High-Power Capability:** Handles up to 100 Watts/channel RMS.
- **Override:** Allows Page/Doorbell signals to override the music at a preset level even with volume turned all the way down or with the VSE2 in Mute.
- **Impedance Matching (1X/2X/4X/8X):** Allows multiple speaker pairs to be connected to a single pair of amplifier channels.
- **IR In/Out:** A built-in IR receiver allows the VSE2 to be controlled from universal remotes, keypads, VIA! Color LCD Touch Screen, or outboard IR receivers. IR can be sent to the VSE2 using an IR emitter or through the RJ45 jack on the rear of the unit. IR can be sent from the IR output to source equipment, IR distribution networks or whole-house controllers.
- **Sense Input:** This option determines if a High to Low level transition on the Sense Input mutes the VSE2's volume. When voltage drops to a Low level, the VSE2 mutes. The transition to High voltage level DOES NOT un-mute the VSE2, however. A physical button press is required to un-mute this device. This allows the system or zone to be turned on without all of the VSE2s in the system playing audio. Each VSE2 will turn on when the Zone or System turns on, but they will all be muted.

When connecting to ELAN S6, S8.6, or S12 systems, the Sense Input feature can be used for either zone-specific or systemwide detection. ELAN Z•systems provide system On/Off detection only. This feature can be disabled.



- **Sleep Mode:** Allows automatic muting of the VSE2 after a specified period of time (ten minutes, thirty minutes, one hour, or two hours).
- **Talkback LED:** LED indicator flashes when IR activity is received through the built-in IR receiver. This feature can be disabled.
- **Default Volume:** This option guards against high volume un-mutes. Determines maximum turn on volume level when an IR VOLUME UP command is sent. This feature can be disabled.
- **On Default Volume Check:** This option determines if the Default Volume is used as the maximum level when the VSE2 is un-muted by an IR ON Command. This feature can be disabled.
- **Code Grouping:** Allows independent control of VSEs connected to the same IR wiring.
- **Preset Volume Levels:** Eleven preset levels allow user to obtain a specified volume level with one button press.
- **Programmable Volume Jumps:** Adjustable rate of volume increment when using Volume Level Presets allows for Fast Ramping, Slow Ramping, or Instant (no ramping).
- **Variable Speed Ramping:** Volume Up speed depends on volume level. As the volume level reaches higher levels, the speed of volume ramping decreases. This feature can be disabled.
- **PTC-Thermal Protection Circuit:** When the PTC detects problems such as, too much power, crossed speaker wiring, or improper impedance, the circuit will open, protecting the volume control. When the problem has been corrected, the circuit will close and resume operation.



Installation

Rough-in

The VSE2 fits into most 18 cu. in. rough-in boxes. DO NOT install the VSE2 in the same electrical box as high-voltage (110, 240VAC) devices such as dimmers, light switches, etc. as these devices will cause harmful interference and create buzzing, humming, or other audio interference. Close proximity to high-voltage devices can also cause undesired IR operation.

Like any IR device, the VSE2's IR receiver is susceptible to interference from ambient light, sunlight, or plasma television radiation. Please do not mount the unit in locations susceptible to these conditions.

Note: The VSE2 is not warranted for outdoor installation.

Wiring

Four-conductor speaker wire and Cat-5 cable should be run from the main equipment location where the system's amplifier is located to the mounting location for each VSE2. The speaker terminals on this unit will accommodate 14 to 24 AWG stranded copper speaker wire. Runs that exceed 150 feet should use heavier gauge wire, but 16 or 18 AWG is usually sufficient. Check local building codes for specific guidelines regarding in-wall wire runs. Cat-5 cable is required when installing this unit to provide Power, Override, Sense Input, IR In, and IR Out. This unit must be connected to power in order to function.

Speaker Connections

1. Verify that the amplifier is powered down. Do not connect the RJ45 connector of the VSE2 at this point.
2. Strip back 1/8" of the insulation from each conductor of the speaker wire. Twist and verify that there are no frayed ends.
3. Remove the AMPLIFIER and SPEAKER connectors from the volume control. Connect the L+, L-, R+, R- conductors from the amplifier to the appropriate terminal on the AMPLIFIER connector. Make sure to maintain proper +/- polarity!
4. Connect the wires from the speakers to the appropriate terminals on the SPEAKER connector, again ensuring proper +/- polarity.
5. Replace the AMPLIFIER and SPEAKER connectors.

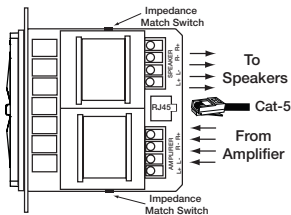

RJ45 Connections

1. Use ELAN C45P pre-terminated RJ45 cables or crimp your own using the ELAN standard color code and pin-out shown below.
2. Consult the provided diagrams for specific Cat-5 wiring requirements for stand-alone or ELAN system operation.
3. Once proper connections are made at the head-end, plug the RJ45 connector into the jack on the rear of the VSE2.
4. Install the unit in the wall using the provided screws.
Be careful not to place tension on the Cat-5 cable.
5. Test and adjust/program features and levels as described later in this manual.

VSE2 PIN ASSIGNMENT

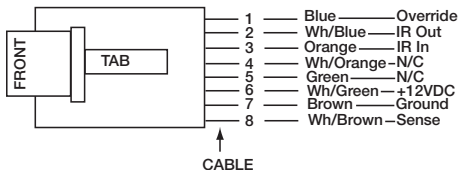

Sense Input Connections

If the Sense Input feature is being used, the VSE2 will mute when voltage drops to a Low level but does not un-mute when voltage returns to a high level. The VSE2 will turn on in a muted state. This allows the system or zone to be turned on without the VSE2(s) playing audio. Stand-alone applications can simply use a power supply plugged into to a switched outlet and connected to the Sense Input wire (Br/White) and Ground (Brown.) When connecting to an ELAN S6, S8.6 or S12 system, either zone-specific or system-wide sensing is possible. ELAN Z• systems will provide system ON/OFF only.

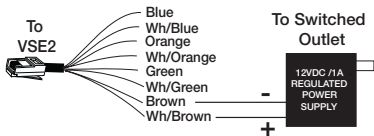
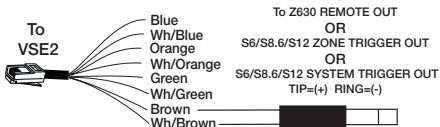

IR Input

The VSE2 has an IR Output (utilizing the built-in IR receiver) and an IR Input (to control the VSE2 from another device.) When designing systems with sub-zones, this IR Input will allow individual sub-zone control (including Volume) from a keypad without having to use a separate Volume Control mounted in the wall.

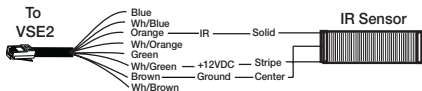
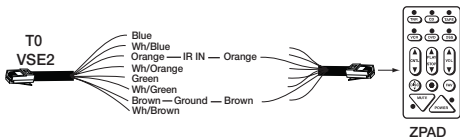

Configuration/Applications

Stand-Alone Configuration

The VSE2 can be used in stand-alone configurations without using an ELAN whole-house controller. Each stand-alone scenario will be slightly different, but all will connect the same way as the following diagram shows.

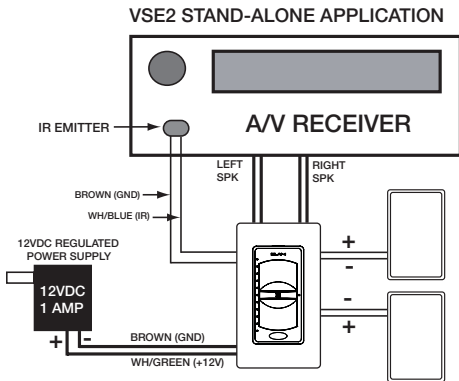



The basic connections for stand-alone systems are as follows:

- 1. Amplifier Input:** Speaker wires from the amplifier (L+/-, R+/-)
- 2. Speaker Output:** Speaker wires to speakers (L+/-, R+/-)
- 3. Power:** +12 Volts DC & Ground (RJ45 +12VDC=Gr Wh,GND=Br)
- 4. IR:** IR Output and Ground (RJ45 IR=Wh/BI, GND=Br)

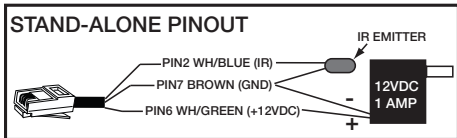



ELAN System Configurations

The VSE2 is ideally suited for many ELAN whole-house audio distribution applications. Features such as Volume Control Override, Impedance Matching, Sense Input, and the built-in IR receiver allow this unit to seamlessly integrate into basic or complex ELAN systems. Following are diagrams showing typical applications using the VSE2 in ELAN S and Z system designs.

NOTE: Zones vs. Sub-Zones

- A “Zone” is defined as an area of a whole-house audio system that has separate source control/selection capabilities.
- A “Sub-Zone” is a room or area that shares source selection/control with another area, but typically has separate ability to control volume for the sub-zone.

ELAN S6 System Overview

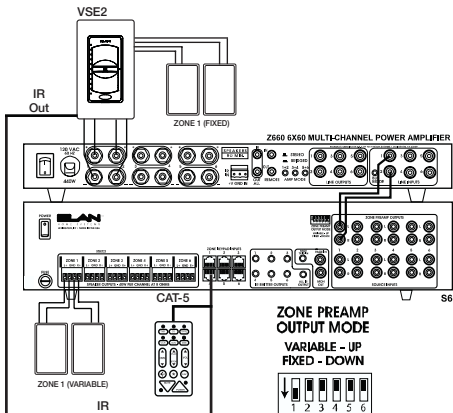

ELAN S8.6 System Overview

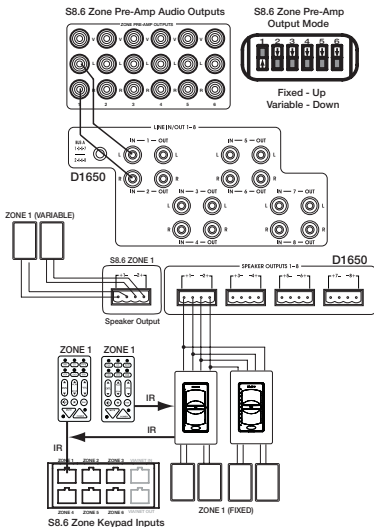

ELAN S12 System Overview

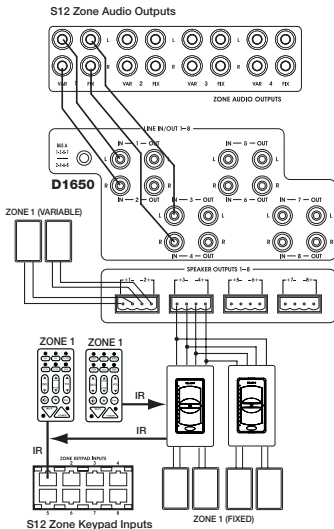

ELAN Z•System Overview

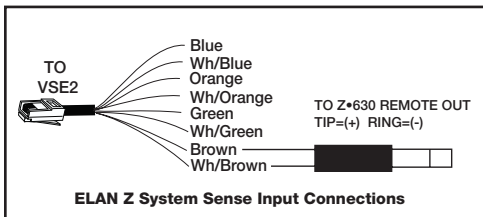
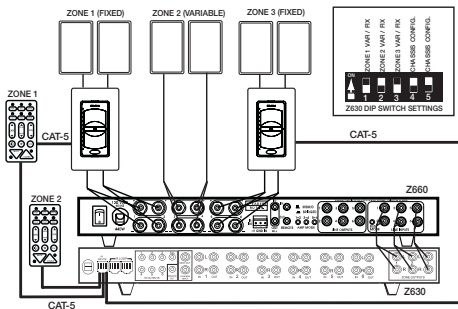



PVSE Precision Panel

Use of ELAN's PVSE Precision Panel will greatly simplify integration of electronic volume controls with the S6/S8.6/S12. The PVSE features independent connections for Override, IR and Sense; plus connectors for easy routing of VSE IR signals to the System Precision Panel (SPP). Two RJ-45 jacks on the rear of the panel make it easy to route override signals to the PZ600 Communication Controller Precision Panel, and to link multiple PVSE panels together. ELAN recommends the use of a PVSE Precision Panel in any S6/S8.6/S12 application, especially where multiple VSE2s are being utilized.

The diagram below shows the wiring of a single electronic volume control to a PVSE, then to a SPP Precision Panel. See the **PVSE Installation Manual** for specific applications and wiring instructions.

PVSE/SPP/Electronic Volume Control Connections
(speaker/amp connections not shown)

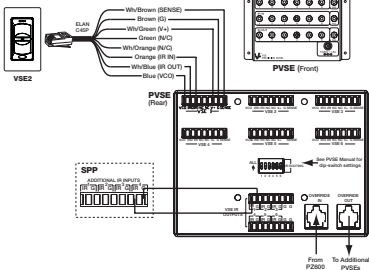

PZ600 Precision Panel

The PZ600 Precision Panel facilitates the connection of telephone service, page, doorbell and override signals, relays and door stations to the Z•600 Communications Controller and ELAN S Series Multi-Room Controllers. Use of the PZ600 in conjunction with the PVSE Precision Panel makes VSE2 connections very straightforward when being used in an Z or S6/S12 system. See the **PZ600 Installation Manual** for specific applications and wiring instructions.

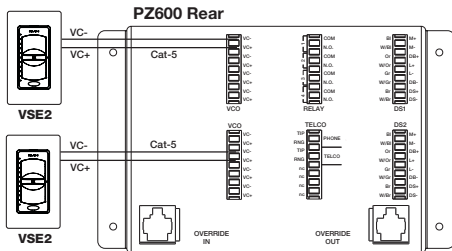

ELAN S8.6/S12 Connections w/ COM2 and VSE2

Using Internal Power of COM2 for Override No SPP or PVSE

When an external power supply is required (see p.4 Maximum Number Of VSE2s Per ELAN System Controller), ELAN recommends the use of a PVSE Precision Panel to improve reliability and simplify connections.

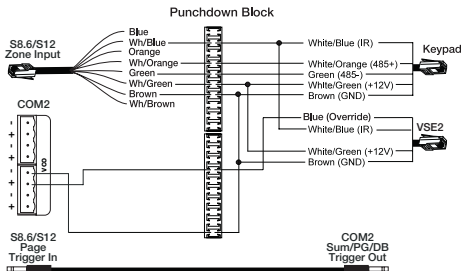

Override Connections

ELAN System6

w/ COM2 and VSE2 - No SPP

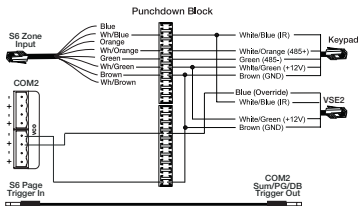

ELAN S8.6/S12

w/ COM2 and Multiple VSE2's - No SPP

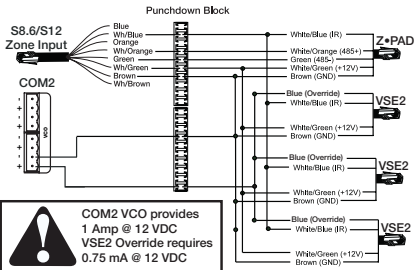

ELAN System6

Using a SPP Precision Panel (VSE2 Located in Zone)

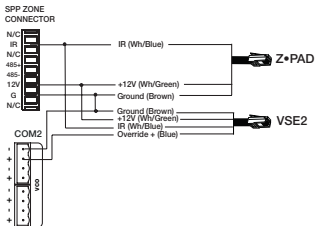

ELAN Z•System

Using a PZ6 Precision Panel (VSE2 Located at Head-End Controlled w/ Z•PAD & IR Emitter)

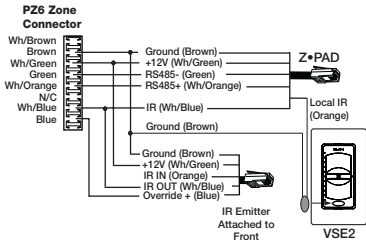

ELAN Z•System Connections

Using a PZ6 Precision Panel (VSE2 Located at Head-End Controlled w/ Z•PAD Using VSE2 IR Input)

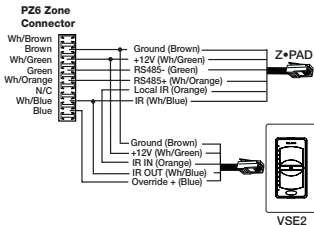

Maximum Number Of VSE2s Per ELAN System Controller

**Each ZONE INPUT
RJ45 Jack (except Z•630)
Provides 12VDC 300mA.**

You may choose to load each of the **ZONE INPUTS** with any combination of Olés, IR Receivers, or Electronic Volume Controls as long as the total current consumption **DOES NOT EXCEED 300mA.** (Z•630 not to exceed 200mA.)

Total Current Consumption

VSE2 and all electronic volume controls = 40 mA
Olé = 150mA
Keypad w/IR Tube = 65 mA
Z•025 = 85mA
Additional IR Receivers = 10mA

Connecting Multiple VSE2s

In certain applications, it may be necessary to connect multiple VSE2s in parallel. Discrete control of these units is possible if CODE GROUPING is enabled. Keep power requirements in mind when connecting multiple VSE2s and use an appropriate power supply for the number of units that will be on the circuit.

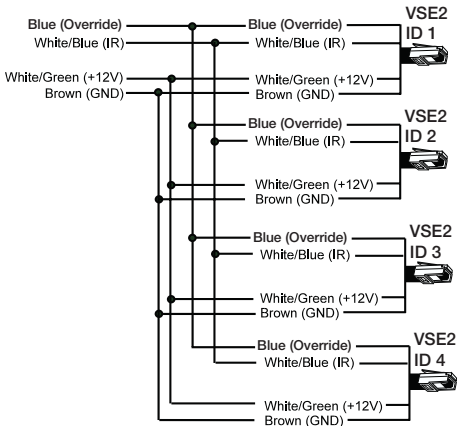

Settings

Default Volume Level

If the pre-muted volume level of the VSE2 was higher than the Default Volume level, and the VSE2 is un-muted by any of the following commands, the VSE2 will be restored to the Default Volume level:

- VOLUME UP/VOLUME DOWN Button
- IR VOLUME UP/VOLUME DOWN
- IR ON (only if “On Default Volume Check” is enabled - see below)

To set the DEFAULT VOLUME LEVEL:

1. Set the VSE2 to the desired level that is to be set as the Default Level.
2. Press and hold the MUTE button. While continuing to press the MUTE button, press and hold the VOLUME DOWN button.
3. When the POWER SENSE LED starts to blink, the Default Volume level is set.



Override Volume Level

Override allows Page/Doorbell signals to override the music at a preset level even with volume turned all the way down or with the VSE2 in Mute. When the Override Input receives a signal, the VSE2's volume level will go to the programmed Override Volume level. The VSE2's volume will stay at this temporary level until one of the following occurs:

- The signal sent to the Override Input stops. The VSE2 will revert back to the state it was before the Override Input received a signal.
- Any command is sent or the Sense Input signal is removed.

The Override Volume level is now set as the new VSE2 volume level, and the command that was detected will be acted upon. Removing the signal from the Override Input now has no affect.

To set the OVERRIDE VOLUME LEVEL:

1. Use the VOLUME UP/DOWN buttons to find a suitable level for the Page/Doorbell Override signal.
2. Press and hold the MUTE button. While continuing to press the MUTE button, press and hold the VOLUME UP button.
3. When the POWER SENSE LED starts to blink, the OVERRIDE LEVEL is set.

Sleep Mode

SLEEP MODE causes the VSE2 to automatically mute after a specified period of time (ten minutes, thirty minutes, one hour, or two hours). Once SLEEP MODE is enabled, it may be disabled by manually muting the VSE2. The VSE2 can then be un-muted. No other commands affect the Sleep countdown, but other commands will still work normally. During the Sleep countdown, the POWER SENSE LED toggles OFF/ON at one second intervals.

To set the SLEEP MODE:

- 1. 10 MINUTE SLEEP TIMER:** Press and hold the MUTE button for two seconds. The TALKBACK LED will blink once.
- 2. 30 MINUTE SLEEP TIMER:** Press and hold the MUTE button for three seconds. The TALKBACK LED will blink twice.
- 3. 1 HOUR SLEEP TIMER:** Press and hold the MUTE button for four seconds. The TALKBACK LED will blink three times.
- 4. 2 HOUR SLEEP TIMER:** Press and hold the MUTE button for five seconds. The TALKBACK LED will blink four times.



Programmed Settings

The following advanced features must be programmed and/or adjusted using IR codesets found in VIA![®]TOOLS setup software version 6.0 or higher:

- IR CODE GROUPING programming
- VARIABLE VOLUME JUMPS & VARIABLE VOLUME RAMPING adjustments
- ON DEFAULT VOLUME CHECK enable/disable
- SENSE INPUT enable/disable
- TALKBACK LED enable/disable

To program the VSE2, press and hold the MUTE button while sending commands to the IR Sensor located on the front of the VSE2 from the VIA!TOOLS IR Library through a VIA![®]Learner or programmable hand-held remote. VSE2s are set to VSE ID 1 by default. Use the "VSE ID 1" codeset in VIA!TOOLS when programming units that are not connected to the same IR wiring (when not using the CODE GROUP feature).

To access VSE2 IR codesets in VIA!TOOLS:

1. Open VIA!TOOLS.
2. Click on "Tools".
3. Click on "IR Library".
4. Click "+" next to "ELAN" (the ELAN Remote File).
5. Navigate to the "VSE CONFIG" and/or "VSE ID Setup" files.
6. Select the desired command in the "IR Commands" box.
7. Click on "Test IR". The selected IR code will be sent out of the "TEST IR" Blaster located on the back of the VIA!Learner.



Code Group

CODE GROUPs allow discrete control of multiple VSE2s that are connected to the same IR wiring. Make sure to assign different CODE GROUP IDs to each VSE2 in the system. VSE2s are set to VSE ID 1 by default. Use the "VSE ID 1" codeset when programming units that are not connected to the same IR wiring (when not using the CODE GROUP feature).

To set the CODE GROUP for a particular VSE2:

1. Open VIA!TOOLS and follow the steps listed above to navigate to the "VSE ID Setup" file.
2. Press and hold the MUTE button.
3. While continuing to hold the MUTE button, select the desired "ID X" command then click on "Test IR".
4. When the POWER SENSE LED starts to blink, the CODE GROUP is set.

Once the IDs are assigned to the various VSE2s in the system, buttons can be programmed on keypads, VIA! Touch Panels, hand-held remotes, or other devices to control various functions of the VSE2s. Thirty-two discrete codesets are available in VIA!TOOLS for this purpose.



Variable Speed Ramping

Volume Up speed depends on volume level. As the volume level reaches higher levels, the speed of volume ramping decreases. Volume Ramping is defined as any continuous VOLUME UP or VOLUME DOWN command.

- **VARIABLE SPEED RAMPING (Default) - VOLUME DOWN** ramps at 100ms. **VOLUME UP** speed depends on the volume. As the volume level reaches higher levels, the speed of the ramping starts to slow.
 - Levels 1, 2, 3, 4 take 100ms to step
 - Levels 5, 6, 7, 8 take 150ms to step
 - Levels 9, 10, 11 take 200ms to step
- **CONSTANT SPEED RAMPING** – Each volume step takes 100ms

To set **VARIABLE SPEED RAMPING** options for a particular **VSE2**:

1. Open **VIA!TOOLS** and follow the steps listed above to navigate to the "VSE CONFIG" file.
2. Press and hold the **MUTE** button.
3. While continuing to hold the **MUTE** button, select the "Constant Vol Ramps" or "Variable Vol Ramps" command then click on "Test IR".
4. When the **POWER SENSE LED** starts to blink, **VARIABLE SPEED RAMPING** is set.

Volume Jumps

VOLUME JUMPS occur when volume level changes more than one step. VOLUME JUMPS can be Fast Ramping (Default - 30ms between steps), Slow Ramping (50ms between steps), or Instantaneous.

To set VOLUME JUMPS for a particular VSE2:

1. Open VIA!TOOLS and follow the steps listed above to navigate to the "VSE CONFIG" file.
2. Press and hold the MUTE button.
3. While continuing to hold the MUTE button, select the "Fast Ramp", "Slow Ramp", or "Instant Jumps" command then click on "Test IR".
4. When the POWER SENSE LED starts to blink, the VOLUME JUMP is set.



On Default Volume Check

This option determines if the Default Volume is used as the maximum level, when the VSE2 is un-muted by an IR ON Command.

To set ON DEFAULT VOLUME CHECK for a particular VSE2:

1. Open VIA!TOOLS and follow the steps listed above to navigate to the "VSE CONFIG" file.
2. Press and hold the MUTE button.
3. While continuing to hold the MUTE button, select the "Max Turn On Enable" or "Max Turn On Disable" command then click on "Test IR".
4. When the POWER SENSE LED starts to blink, ON DEFAULT VOLUME CHECK is set.

Sense Input

This option determines if a High to Low level transition on the Sense Input mutes the VSE2's volume.

- **ENABLE SENSE INPUT (Default)** - When the SENSE INPUT transitions from High to Low level, the VSE2 will go into a Mute state. When the SENSE INPUT transitions from a LOW to a HIGH level, the VSE2 will not change state.
- **DISABLE SENSE INPUT** - SENSE INPUT level transitions do not make the VSE2 change state.

To enable or disable SENSE INPUT for a particular VSE2:

1. Open VIA!TOOLS and follow the steps listed above to navigate to the "VSE CONFIG" file.
2. Press and hold the MUTE button.
3. While continuing to hold the MUTE button, select the "Sense Enable" or "Sense Disable" command then click on "Test IR".
4. When the POWER SENSE LED starts to blink, SENSE INPUT is set.



Talkback LED

This option determines if the TALKBACK LED indicates IR activity.

- **Enable LED TALKBACK (Default)** - When the Sense Input level is LOW, the TALKBACK LED is normally OFF and flashes ON with IR activity. When the Sense Input level is HIGH, the TALKBACK LED is normally ON and flashes OFF with IR activity.
- **Disable LED TALKBACK** - When the SENSE INPUT level is LOW, the TALKBACK LED is normally OFF, and does not flash with IR activity. When the SENSE INPUT level is HIGH, the TALKBACK LED is normally ON, and does not flash with IR activity.

To enable or disable TALKBACK for a particular VSE2:

1. Open VIA!TOOLS and follow the steps listed above to navigate to the "VSE CONFIG" file.
2. Press and hold the MUTE button.
3. While continuing to hold the MUTE button, select the "LED Enable" or "LED Disable" command then click on "Test IR".
4. When the POWER SENSE LED starts to blink, TALKBACK is set.

Factory Default

To return the VSE2 to Factory Default condition:

1. Remove the unit from power.
2. Press the VOLUME UP and VOLUME DOWN buttons simultaneously.
3. Re-connect the unit to power.
4. Continue holding VOLUME UP and VOLUME DOWN for several seconds until the POWER SENSE LED stops blinking.

Impedance Match Settings

Switch settings on the VSE2 determine the Impedance Match settings as shown below.

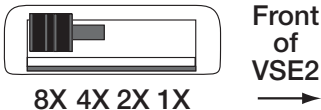



Switch position depends on three things:

1. The minimum impedance rating of the amplifier being used.
2. The number of speakers being connected to the amplifier channel.
3. The nominal impedance of the speakers being utilized.

Once the above information has been determined, use the following equations to determine the correct Impedance Match setting for each specific application. Two equations are necessary:

$$\#1 \frac{\text{Impedance Rating of Speakers}}{\# \text{ of Speakers Connected to Amp Channel}} = \text{System Impedance}$$
$$\#2 \frac{\text{Minimum Impedance Rating of Amp}}{\text{System Impedance}} = \text{Impedance Match Switch Setting}$$

Example:

Amplifier's Minimum Impedance Rating = 8 ohms

of Speakers on this Channel = 4

Speaker Impedance = 8 ohms

$$\#1 \frac{8 \text{ Ohm Speaker}}{4 \text{ Speakers}} = \frac{2 \text{ Ohm}}{\text{System Impedance}}$$
$$\#2 \frac{8 \text{ Ohm Stable Amp}}{2 \text{ Ohm System Impedance}} = 4X \text{ Switch Setting}$$

Most speakers are rated at 4, 6, or 8 ohms. If connecting speakers of different impedances to an amplifier, an average impedance must be determined; i.e. one pair of 4 ohm speakers is the equivalent of 2 pair of 8 ohm speakers. All 6 ohm speakers should be entered into the equation as 4 ohm speakers. All volume controls connected to an amplifier channel should have the same Impedance Match setting. Never create settings that cause the amplifier to see an impedance below its minimum impedance rating as this can cause damage to the amplifier.

Operation

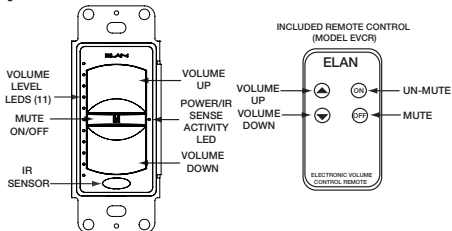

Turning the VSE2 ON

The VSE2 Volume level LED's are OFF

1. Press the MUTE button on the VSE2.
2. Press ON on the included remote.
3. Issue any ELAN Source Select IR command.

NOTE: When the VSE2 is turned ON using any of the above methods, the Volume level is restored to the last setting before the VSE2 was turned OFF.

4. Press the VOLUME UP button on the VSE2.
5. Press VOLUME UP on the included remote.
6. Issue any ELAN VOLUME UP IR command.

NOTE: When the VSE2 is turned ON using any of the above methods Volume level is restored to the last setting before the VSE2 was OFF but no higher than the OVER-RIDE Volume level setting.



7. Press the VOLUME DOWN button on the VSE2
8. Press VOLUME DOWN on the included remote.
9. Issue any ELAN VOLUME DOWN command.

NOTE: When the VSE2 is turned ON using any of the above methods, the Volume level is set to the lowest audible level.

Turning the VSE2 OFF

The VSE2 Volume level LED's are ON

1. Press the MUTE button on the VSE2.
2. Press OFF button on the included remote.
3. Issue any ELAN SYSTEM OFF command.

Controlling Volume

1. Press VOLUME UP or VOLUME DOWN buttons on the VSE2.
2. Press VOLUME UP or VOLUME DOWN buttons on the included remote control.
3. Issue a VSE VOLUME UP or VOLUME DOWN command from a keypad, VIA! Touch Panel, hand-held remote, or third-party controller (IR commands are located in VIA!TOOLS IR Library).

NOTE: The VSE2 will respond to VSE VOLUME UP/DOWN commands found in the VIA!®TOOLS IR Library or from the optional remote. The included EVCR remote can be used to teach other learning remotes when necessary.

Muting the Volume

1. Press the MUTE button on the VSE2.
2. Press the MUTE button on an ELAN remote control.
3. Issue any ELAN MUTE command.

TROUBLESHOOTING

Symptom	Possible Cause	Solution
VSE2 does not power ON	<ol style="list-style-type: none"> 1. Power supply not connected. 2. RJ-45 pinout incorrect crimped improperly. 3. Poor connection on Precision Panel 	<p>Plug +12VDC into AC outlet.</p> <p>Verify and correct RJ-45 wiring at Volume Control location</p> <p>Verify and correct wiring punchdown connection</p>
No source control when using built-in IR receiver	<ol style="list-style-type: none"> 1. Wiring: IR signal not reaching input. 2. Flooding from ambient light or plasma t.v. 	<p>Verify and correct wiring (see above)</p> <p>Check IR indicator LED. If it flickers, or is constantly lit, IR flooding is indicated</p>



Symptom	Possible Cause	Solution
No audio present	<ol style="list-style-type: none">1. Source not playing2. Volume Muted or turned all the way down3. Amplifier/ Speaker connectors reversed4. Speakers in room miswired or defective.	<p>Press Play, turn ON etc.</p> <p>Increase volume</p> <p>Check and correct connections.</p> <p>a. Test speaker at back of amplifier. b. Verify connections</p>
Poor audio quality	<ol style="list-style-type: none">1. Clipping or distortion2. Speakers out of phase3. Incorrect Impedance Match settings4. Incorrect assignment of left/right source RCA cables or speaker cables	<p>Reduce Receiver/Amplifier level</p> <p>Carefully check polarity of each speaker</p> <p>See Imp. Match Section starting on pg.35 and set switches correctly</p> <p>Isolate to source or room and correct</p>



Specifications

Power Rating--Nominal	100 Watts RMS per Channel
Frequency Response	20-20KHz +/- 0.5dB @ 8 Ohms
Total Harmonic Distortion	< 1%
Impedance Settings	Variable 1X/2X/4X/8X
Minimum Speaker Load	4 Ohms
Dynamic Range	49 dB (max to min. audible)
Override Current Draw	0.75 mA (Logic only)
Sense Current Draw	25 mA
Maximum Current Draw	40 mA
Operating Voltage	12 Volts DC
Sense Voltage	9-12 Volts DC
Override Voltage	9-12 Volts DC
Color	White

Trim kits available in White, Ivory, Almond, Light Almond, Black, and Brown.

Limited Lifetime Warranty

ELAN HOME SYSTEMS, L.L.C. ("ELAN") warrants to the original retail purchaser that the VSE2 Electronic Volume Control is free from defects in materials and workmanship, provided that the product was purchased from an authorized ELAN Home Systems Dealer.

If the above purchaser discovers such item was not as warranted above and promptly notifies ELAN in writing, ELAN shall repair or replace the items at the company's option. This warranty shall not apply (a) to equipment not manufactured by ELAN, (b) to equipment which shall have been installed by other than an authorized ELAN installer, (c) to installed equipment which is not installed to ELAN's specifications, (d) to equipment which shall have been repaired or altered by others than ELAN, (e) to equipment which shall have been subjected to negligence, accident, or damage by circumstances beyond ELAN's control, including, but not limited to, lightning, flood, electrical surge, tornado, earthquake, or any other catastrophic events beyond ELAN's control, or to improper operation, maintenance or storage, or to other than normal use of service. With respect to equipment sold by, but not manufactured by ELAN, the warranty obligations of ELAN shall in all respects conform and be limited to the warranty actually extended to ELAN by its supplier. The foregoing warranties do not cover reimbursement for labor, transportation, removal, installation, or other expenses which may be incurred in connection with repair or replacement.

Except as may be expressly provided and authorized in writing by ELAN, ELAN shall not be subject to any other obligations or liabilities whatsoever with respect to equipment manufactured by ELAN or services rendered by ELAN.

THE FOREGOING WARRANTIES ARE EXCLUSIVE AND IN LIEU OF ALL OTHER EXPRESSED AND IMPLIED WARRANTIES EXCEPT WARRANTIES OF TITLE, INCLUDING BUT NOT LIMITED TO IMPLIED WARRANTIES OF MERCHANTABILITY AND FITNESS FOR A PARTICULAR PURPOSE.



1300 E. New Circle Rd. Ste. 150 Lexington, KY 40509

www.elanhomesystems.com

P/N9900894 REV:B

INSTR, INSTL, VSE2
LINEAR P/N 9900894 REV:B
INK: BLACK
MATERIAL: 60 LB WHITE COATED PAPER
SCALE: 1-1
SIZE: 7.000 X 4.500, TOL: +/- .040
FOLDING: ALBUM FOLD CENTER STAPLE
FOLD TO 3.500 X 4.500
PAGES: 44
NOTE: ARTWORK CREATED BY ELAN HOME
SYSTEMS
THIS MANUAL MUST BE ROHS COMPLIANT